



WDH-iK4

120.1 -540.2

MANUAL

FOR INSTALLATION,
USE AND MAINTENANCE



M0F100003-01 03-22

R513A

Dear Customer,

We congratulate you on choosing these product.

Clivet is being working for years to offer systems able to assure the maximum comfort for long time with high reliability, efficiency , quality and safety. The target of the company is to offer advanced systems, that assure the best comfort, reduce the energy consumption, the installation and maintenance costs for all the life-cycle of the system.

With this manual, we want to give you information that are useful in all the phases: from the reception, to the installation and use until the disposal so that a system so advanced offers the best procedure of installation and use.

Best regards and have a nice reading !

CLIVET Spa

The data contained in this manual is not binding and may be changed by the manufacturer without prior notice. All reproduction, even partial, is prohibited. © Copyright - CLIVET S.p.A. - Feltre (BL) - Italia

1	Safety considerations	4
2	Before installation	7
3	Handling	8
4	Selecting the installation site	10
5	Water connections	11
6	Electrical connections	20
7	Start-up	29
8	Control	39
9	Maintenance	47
10	Antivibration mounts	54
11	Decommissioning	57
12	Residual risks	58
13	Technical information	60

1 SAFETY CONSIDERATIONS

Safety

Operate in compliance with safety regulations in force .
Use single protection devices: gloves, glasses, helmet etc.

Manual

The manual provides correct unit installation, use and maintenance.
It is advisable to read it carefully so you will save time during operations.
Follow the written indications so you will not cause damages to things and injuries people.

Preliminaries

Only qualified personnel can operate on the unit, as required by the regulation in force.

Risk situations

The unit has been designed and created to prevent injures to people.
During designing it is not possible to plane and operate on all risk situation.
Read carefully “Residual risk” section where all situation which may cause damages to things and injuries to people are reported.
Installation, starting, maintenance and repair required specific knowledge; if they are carried out by inexperienced personnel, they may cause damages to things and injuries people.

Intended use

Use the unit only:

- cooling water or a water and glycol
- keep to the limits foreseen in the technical schedule and in this manual

The manufacturer accepts no responsibility if the equipment is used for any purpose other than the intended use.

Installation

Outdoor installation

The positioning, hydraulic system, refrigerating, electrics and the ducting of the air must be determined by the system designer in accordance with local regulations in force.

Follow local safety regulations.

Verify that the electrical line characteristics are in compliance with data quotes on the unit serial number label.

Maintenance

Plan periodic inspection and maintenance in order to avoid or reduce repairing costs.

Turn the unit off before any operation.



Pay particular attention to:

⇒ warnings / prohibitions / danger indicating particularly important operations or information, operations that cannot be done, which compromise the functionality of the unit or which may cause damage to things or persons.

Indoor installation

Modification

All unit modifications will end the warranty coverage and the manufacturer responsibility.

Breakdown/Malfunction

Disable the unit immediately in case of breakdown or malfunction.

Contact a certified service agent.

Use original spares parts only.

Using the unit in case of breakdown or malfunction:

- voids the warranty
- it may compromise the safety of the unit
- it may increase time and repair costs

User training

The installer has to train the user on:

- start-up/shutdown
- set points change
- standby mode
- maintenance
- what to do / what not to do in case of breakdown.

Data update

Continual product improvements may imply manual data changes.

Visit manufacturer web site for updated data.

Indications for the User

Keep this manual with the wiring diagram in an accessible place for the operator.

Note the unit data label so you can provide them to the assistance centre in case of intervention (see “Unit identification” section).

Provide a unit notebook that allows any interventions carried out on the unit to be noted and tracked making it easier to suitably note the various interventions and aids the search for any breakdowns.

In case of breakdown or malfunction

- Immediately deactivate the unit
- Contact a service centre authorized by the manufacturer

The installer must train the user, particularly on:

- Start-up/shutdown
- Set points change
- Standby mode
- Maintenance
- What to do / what not to do in case of breakdown

Unit identification

The serial number label is positioned on the unit and allows to identify all the unit features.

The matriculation plate shows the indications foreseen by the standards, in particular:

- unit type
- serial number (12 characters)
- year of manufacture
- wiring diagram number
- electrical data
- type of refrigerant
- refrigerant charge
- manufacturer logo and address

The matriculation plate must never be removed.

It contains fluorinated greenhouse gases.

Serial number

It identifies uniquely each unit.

Must be quoted when ordering spare parts.

Assistance request

Note data from the serial number label and write them in the chart on side, so you will find them easily when needed.

Characteristics of R32 refrigerant:

- minimum environmental impact thanks to the low Global Warming Potential GWP
- low flammability, class A2L according to ISO 817
- low combustion speed
- low toxicity

Serie
Size
Serial number
Year of manufacture
Wiring diagram

Physical characteristics of the R513A refrigerant		
Safety class (ISO 817)	A1	
Boiling point	-29,2	°C
GWP	631	

2 BEFORE INSTALLATION

Reception

You have to check before accepting the delivery:

- That the unit hasn't been damaged during transport
- That the materials delivered correspond with that indicated on the transport document comparing the data with the identification label positioned on the packaging.

In case of damage or anomaly:

- write down on the transport document the damage you found and quote this sentence: "Conditional acceptance clear evidence of deficiencies/damages during transport"
- contact by fax and registered mail with advice of receipt to supplier and the carrier.

NOTE

⇒ *Any disputes must be made within 8 days from the date of the delivery. Complaints after this period are invalid .*

Storage

Respect the indications on the outside of the pack.

In particular:

- ⇒ *minimum ambient temperature -15°C
(possible components damages)*
- ⇒ *maximum ambient temperature +55°C
(possible safety valve opening)*
- ⇒ *maximum relative humidity 95%
(possible damages to electrical components)*

NOTE

⇒ *The unit may not be tilted more than 15° during transport.*

NOTE

Removal of packaging

Be careful not to damage the unit.

Recycle and dispose of the packaging material in compliance with local regulations.

3 HANDLING

- ⇒ Check that all handling equipment complies with local safety regulations (cran, forklifts, ropes, hooks, etc.).
 - ⇒ Provide personnel with personal protective equipment suitable for the situation, such as helmet, gloves, accident-prevention shoes, etc.
 - ⇒ Observe all safety procedures in order to guarantee the safety of the personnel present and the of material.
- A. Verify unit weight and handling equipment lifting capacity.
 - B. Identify critical points during handling (disconnected routes, flights, steps).
 - C. Suitably protect the unit to prevent damage.
 - D. Lifting with balance
 - E. Lifting with spacer bar
 - F. Align the barycenter to the lifting point
 - Gradually bring the lifting belts under tension, making sure they are positioned correctly.
 - Before starting the handling, make sure that the unit is stable.

Do not get on the unit

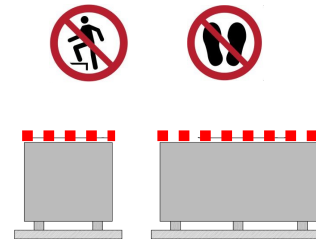

A



B

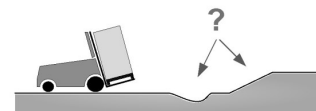

C

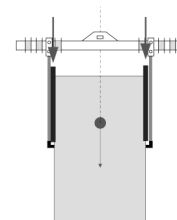

D

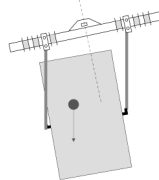
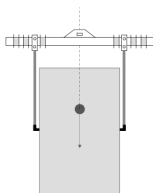

F

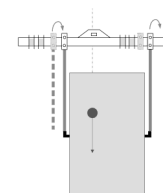

E

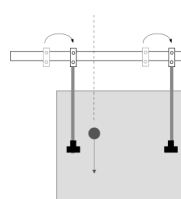
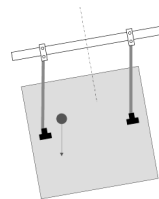

Lifting with forklift

120.1 - 290.1

250.2 - 540.2

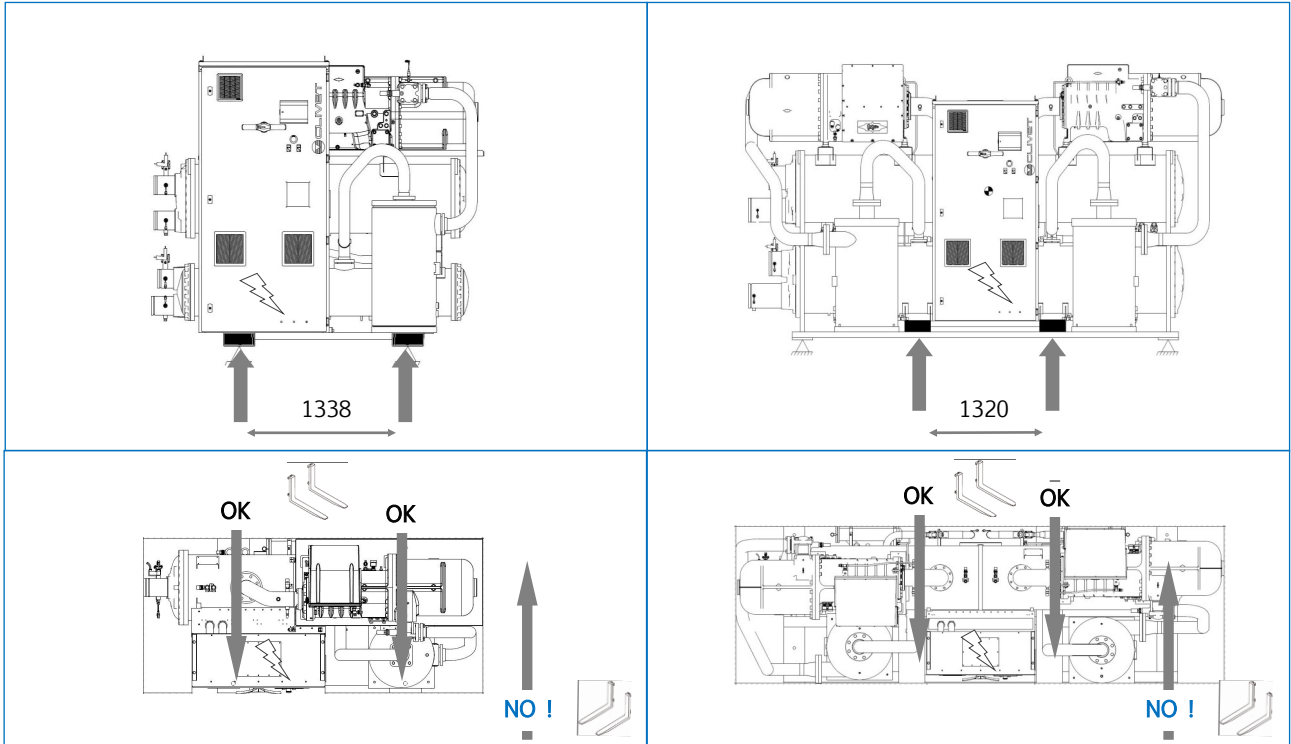

Lifting with balance

Lifting brackets - Option

120.1 - 290.1

250.2 - 540.2

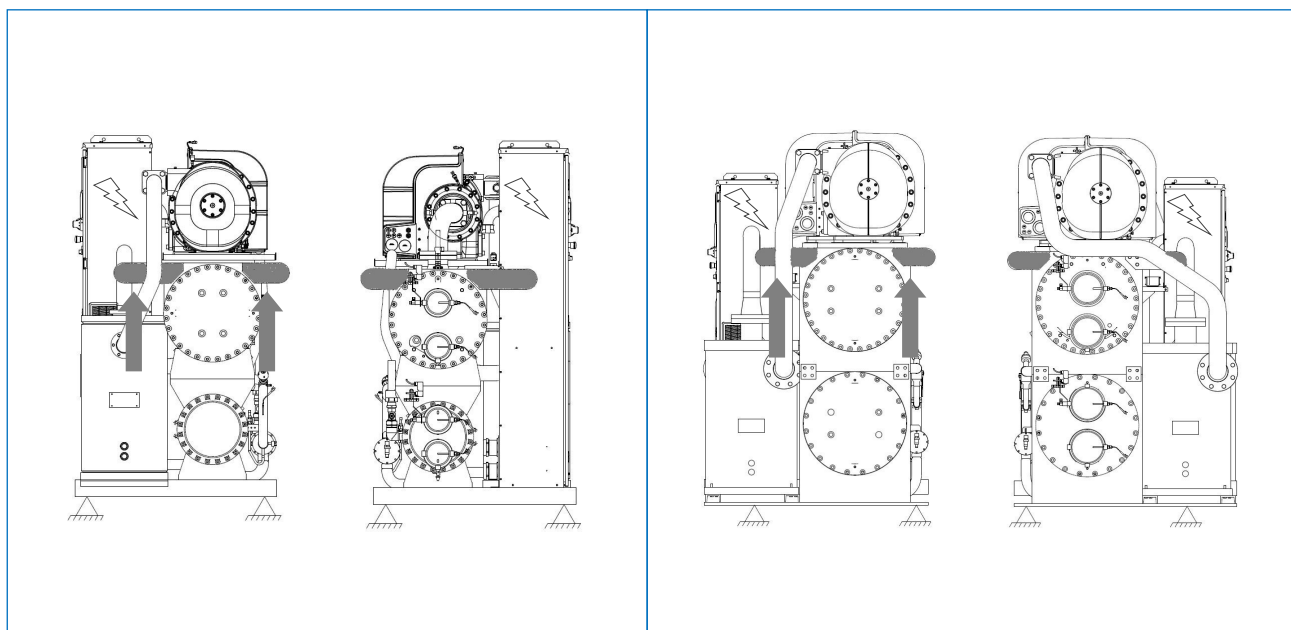

4 SELECTING THE INSTALLATION SITE

Positioning

⇒ Installation must be in accordance with local regulations. If they do not exist, follow EN378.

During positioning consider these elements:

- customer approval
- unit weight and bearing point capacity
- safe accessible position
- functional spaces
- spaces for the air intake/exhaust
- electrical connections
- max. distance allowed by the electrical connections
- water connections

Functional spaces

Functional spaces are designed to:

- guarantee good unit operation
 - carry out maintenance operations
 - protect authorized operators and exposed people
- ⇒ Respect all functional spaces indicated in the TECHNICAL INFORMATION section.

Positioning

Units are designed to be installed:

- INTERNAL
- in fixed positions

⇒ Put the unit in a position where any leaking gas cannot enter buildings or stagnate in closed areas. In the latter case, observe the rules for machinery rooms (ventilation, leak detection, etc.).

Installation standards:

- install the unit raised from the ground
- bearing points aligned and leveled
- avoid installations in places subject to flooding

Limit vibration transmission:

- use anti-vibration devices or neoprene strips on the unit support points
- install flexible joints on the hydraulic connections

A correct circulation of the air is mandatory to guarantee the good unit operating.

Pressure relief valve gas side

The installer is responsible for evaluating the opportunity of installing drain pipes in compliance with the local regulations in force (EN 378).

If ducted, the valves must be sized according to EN13136.

The unit must be level.

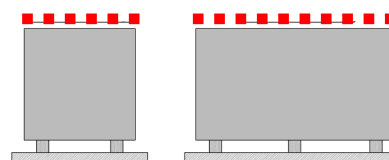
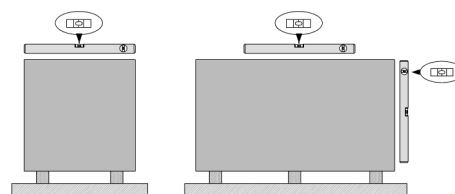

5 WATER CONNECTION

Hydraulic system

The pipes must be designed and manufactured to limit pressure drops as much as possible, i.e. optimise performance of the system. Keep the following to a minimum:

- overall length
- number of bends
- number of vertical changes of direction

If the unit is to replace an existing unit, clean the system thoroughly: see Sequence of operations on the following pages

Water quality

The water quality can be checked by qualified personnel.

Water with inadequate characteristics can cause:

- pressure drop increase
- energy efficiency decrease
- corrosive symptom increase

Water features:

- within the limits indicated by table

Provide a water treatment system if values fall outside the limits.

Cleanliness

Before connecting the water to the unit, clean the system thoroughly with specific products effective to remove residues or impurities that may affect functioning. Existing systems must be free from sludge and contaminants and protected against build-ups.

New systems

In case of new installations, it is essential to wash the entire installation (with the circulator uninstalled) before commissioning the central installation. This removes residues of the installation process (welding, waste, joint products...). The system must then be filled with clean high-quality tap water.

Existing systems

If a new unit is installed on an existing system, the system must be rinsed to avoid the presence of particles, sludge and waste. The system must be drained before installing the new unit. Dirt can be removed only with a suitable water flow. Each section must then be washed separately. Particular attention must also be paid to “blind spots” where a lot of dirt can accumulate due to the reduced water flow. The system must then be filled with clean high-quality tap water. If, after rinsing, the quality of the water is still unsuitable, a few measures must be taken to avoid problems. An option to remove pollutants is to install a filter.

The warranty does not cover damages caused by limestone formations, deposits and impurities from the water supply and/or from failure to clean the systems.

Water quality

The quality of the water is extremely important for the operation and service life of the exchanger. Excessive water hardness can lead to the formation of incrustations on the inner wall of the pipes which can reduce the exchanger's performance.

At the same time, the formation of incrustations can compromise the service life of the elements inside the exchanger.

Below are some of the main elements that determine the quality of water.

Salinity

An increase in salinity leads to an increase in electrical conductivity with the ensuing risk of triggering galvanic interactions which can give rise to corrosion. Keep in mind that when using sea water, the concentration of dissolved salts may vary depending on the geographical position. Do not use sea water if the exchanger has not been specifically built for this type of use.

pH

The pH value is normally set towards alkalinity (6.8 – 8.4). These values should be maintained for correct operation.

Dissolved oxygen.

An increase in the amount of dissolved oxygen can lead to an accentuation of corrosion phenomena.

Biological load

It is determined by the combination of animal and plant microorganisms; it can create anaerobic conditions and make the attack of sulphate-reducing bacteria or differential aeration conditions possible, thereby giving rise to localised corrosion phenomena.

Suspended solids

They can lead to deposits and sediments causing drops in performance and/or corrosion and erosion phenomena.

Marine units

The system has to be equipped with specific anodes that must be checked/replaced regularly. The frequency of these operations depends, among other things, on the salinity of the sea.

Acceptable water quality limits

pH (25°C)	6.8 – 8.4
Electrical conductivity ($\mu\text{S}/\text{cm}$) (25°C)	< 800
Chloride ion ($\text{mg Cl}^-/\text{l}$)	< 150
Chlorine molecular ($\text{mg Cl}_2/\text{l}$)	< 5
Sulphate ion ($\text{mg SO}_4^{--}/\text{l}$)	< 100
Sodium nitrate ($\text{mg NaNO}_3/\text{l}$)	< 100
Alkalinity ($\text{mg CaCO}_3/\text{l}$)	< 100
Total Hardness ($\text{mg CaCO}_3/\text{l}$)	< 200
Iron ($\text{mg Fe}/\text{l}$)	< 1.0
Copper ($\text{mg Cu}/\text{l}$)	< 1.0
Sulphide ion (S^-/l)	none
Ammonium ion ($\text{mg NH}_4^+/\text{l}$)	< 1.0
Silica ($\text{mg SiO}_2/\text{l}$)	50
Maximum particle size to pass (filtration limit) through heat exchanger (mm)	0.87
Total dissolved solids (mg/l)	< 1500
Max Ethylene, Propylene glycol	50%

Recommendations on using copper pipes with substances contained in the water

	Concentration [-] o [mg/l]	Copper
pH-Value	<6	0
	6-8	+
	>8	+
Chloride (Cl-)	<10	+
	10-100	+
	100-1000	+
	>1000	0
Sulphate	<50	+
	50-200	0
	>200	-
Nitrates	<100	+
Free & aggressive Carbonic Acid	<5	+
	5-20	0
	>20	-
Oxygen	<1	+
	1-8	+
	>8	0
Ammonium	<2	+
	2-20	0
	>20	-
Ferric und Manganese	>1	0
Sulfides		-
Free Chlorine	<5	+
Deposable substances		0

Water filter

⇒ *Must be installed immediately in the water input of the unit, in a position that is easily accessible for cleaning.*

⇒ *The filter never should be removed, this operation invalidates the guaranty.*

The filter must have an adequate mesh to prevent the entry of particles greater than:

0,87 mm

Water flow-rate

The design water flow-rate must be:

- inside the exchanger operating limits
- guaranteed also with variable system conditions (for example, in systems where some circuits are bypassed in particular situations)

If the system capacity is below the minimum flow, bypass the system as indicated in the diagram.

If the system capacity exceeds the maximum flow, bypass the system as indicated in the diagram

Minimum system water content

For a proper functioning of the unit a minimum water content has to be provided to the system, using the formula:

Minimum water flow

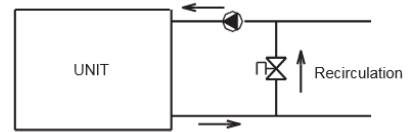

Maximum water flow

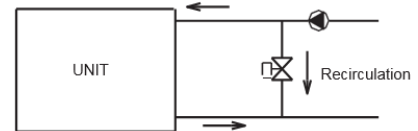

Size	120.1	160.1	200.1	220.1	240.1	270.1	290.1
Liters	2600	2600	5600	5600	5700	5800	5900
Size	250.2	280.2	320.2	360.2	400.2	480.2	540.2
Liters	5200	5300	5400	7900	10800	10800	10800

Risk of freeze

If the unit or the relative water connections can be subject to temperatures close to 0°C:

- Mix water with ethylene glycol, or
- Safeguard the pipes with heating cables placed under the insulation, or
- Empty the system in cases of long non-use

Anti-freeze solutions

Consider that the use of anti-freeze solution determines an increase in a pressure drop.

Make sure that the glycol type utilized is inhibited (not corrosive) and compatible with the hydraulic circuit components.

Do not use different glycol mixture (i.e. ethylic with propylene).

The unit must always be protected from freeze. Otherwise irreversible damage may occur.

% ETHYLENE GLYCOL BY WEIGHT		5%	10%	15%	20%	25%	30%	35%	40%
Freezing temperature	°C	-2,0	-3,9	-6,5	-8,9	-11,8	-15,6	-19,0	-23,4
Safety temperature	°C	3,0	1,0	-1,0	-4,0	,6,0	-10,0	-14,0	-19,0

Cavitation

Cavitation phenomena are caused by air in the water circuit or by particular system situations.

- They can damage the pumps and valves and should therefore be avoided at all costs.

Raccommended connection

The installer must define:

- component type
- position in system

The schemes are indicative.

Evaporator side connection

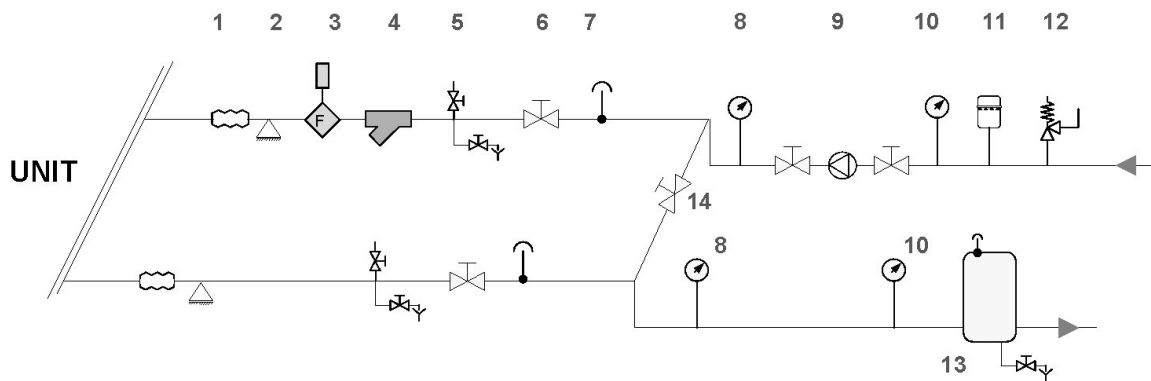

Source side connection

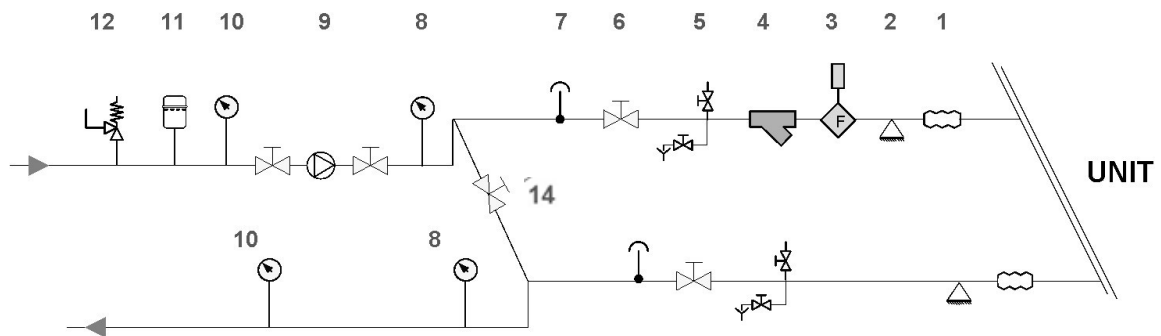

1 anti-vibration joints

2 piping supports

3 water flow switch

4 filter

5 exchanger chemical washing valve
+ drain valve

6 shut-off valve

7 vent

8 pressure gauge

9 pumping group

10 thermometer

11 expansion vessel

12 safety valve

13 inertial accumulation

14 exchanger chemical washing valve

Provide the safety lock.

The bypass must not be opened in normal operation.

Risk of flow rate reduction to the exchanger.

Configuration of hydraulic connections EVAPORATOR

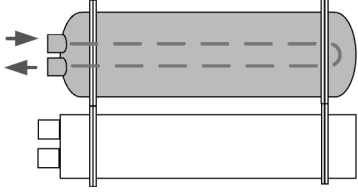
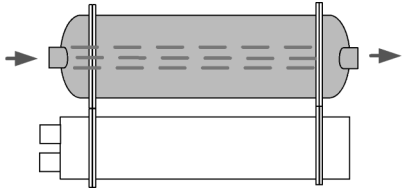
Water flow-rate	Number of passes	Water fittings	scheme
Standard DT = 5°C	2	Left (Std)	
		Right (option)	
Low DT > 6°C	3	opposed	

Warnings on exchangers

Excessive water speed values can cause erosion phenomena and damage the exchangers.

Do not subject the exchangers to excessive vibrations.

Do not subject the exchangers to fatigue loads, whether they are constant or variable.

Configuration of hydraulic connections CONDENSER

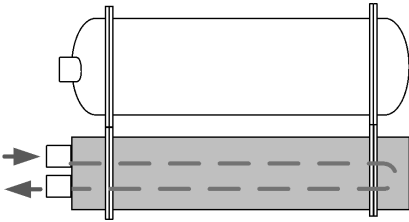
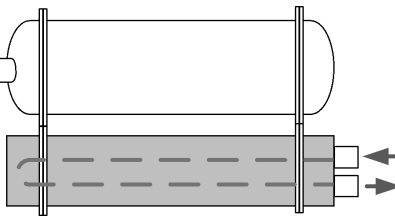
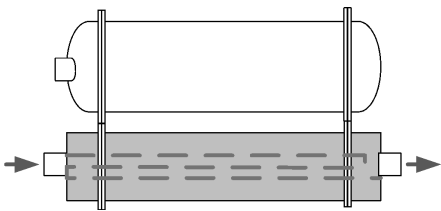
Water flow-rate	Number of	Water fittings	scheme
Standard DT = 5°C	2	Left (Std)	
		Right (option)	
Low DT > 6°C	3	opposed	

Evaporative tower connection

If the unit is used with low outdoor temperatures, provide a bypass circuit in order to keep the condenser inlet temperature above 15 °C.

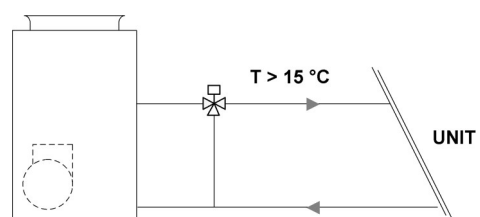

Non-return valve

Provide for the installation of non-return valves (A) in the case of several units connected in parallel.

Flow Switch

The flow switch must be present to ensure shutdown of the unit if water is not circulating.

It has to be installed in a duct rectilinear part, not in proximity of curves that cause turbulences.

Operations sequence

Before starting the unit pump:

1. Close all vents in the high points of the unit's water circuit.
 2. Close all drain shut-off valves in the low points of the unit's water circuit
 - Exchangers
 - Pumps
 - collectors
 - storage tanks
 3. Thoroughly wash the system with clean water: use the bypass to exclude the exchanger from the flow (diagram on previous page) fill and drain the system several times.
 4. Apply additives to prevent corrosion, fouling, formation of mud and algae.
 5. Fill the system
do not use the unit pump
 6. Conduct a leak test.
 7. Isolate the pipes to avoid heat dispersions and formation of condensate.
 8. Leave various service points free (wells, vents, etc).
- ⇒ *Neglecting to wash will lead to the filter having to be cleaned many times and at worst may damage the exchangers and compressors.*

Non-return valve

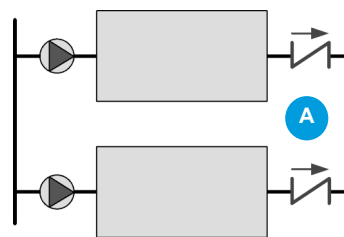

Flow Switch

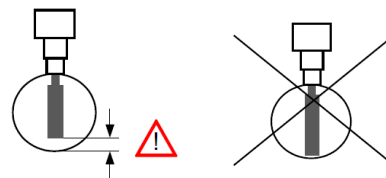
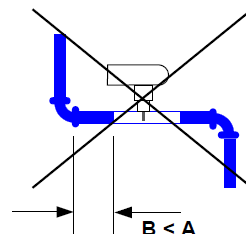
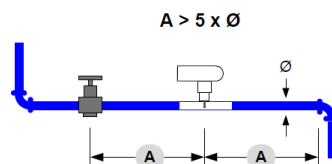

Modulating valve source side

Option

The motorised two-way modulating valve is placed on the thermal source side and is controlled by the unit.

It operates in conjunction with the refrigeration circuit: the modulation via the 0-10V signal - based on the pressure of the refrigerant in the exchanger on the source side - reduces water consumption and ensures the units stays in the expected operating range.

A. Unit in "OCO - Cold only" configuration

The kit includes two valves, one for each circuit.
The two-way valves are three-way type with a closed way.
They can also be used as three-way, by removing the cap closure

B. Unit in 'OHI - Operation with water circuit change-over' configuration

The kit consists of a single valve managed by the unit according to the operating pressures of both circuits.
For sizes 220.2-240.2, three-way valves with one closed port are used, for the other sizes two-way valves are used.

The modulating valves, if not supplied by CLIVET, must have a fast stroke actuator, with an actuation times of 35 sec.

In case of OHI configuration, the valve must be positioned as shown in diagram B, management of different layouts is not allowed.

A

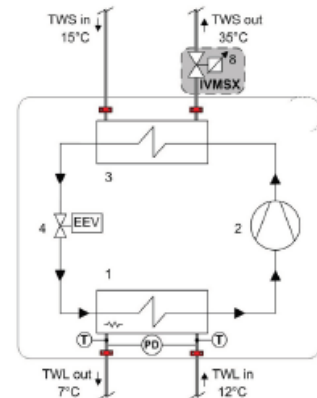

B

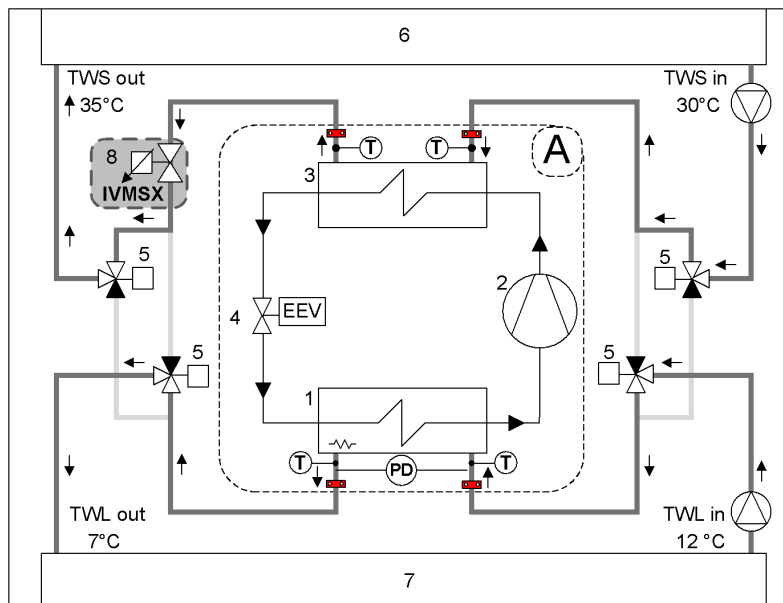

- 1 Internal exchanger (evaporator)
- 2 Compressor
- 3 External exchanger (condenser)
- 4 Electronic expansion valve
- 5 Switching valves (provided by Customer)
- 6 Thermal source (heat rejection)
- 7 Use
- 8 Modulating valve source side (IVMSX accessory)

- T - water temperature probe
- PD - Differential pressure switch
- TWS in - Water inlet source side
- TWS out - Water outlet source side
- TWL in - Water inlet user side
- TWL out - Water output user side

6 ELECTRICAL CONNECTIONS

The characteristics of the electrical lines must be determined by specialized personnel able to design electrical installations; moreover, the lines must be in conformity with regulations in force.

The protection devices of the unit power line must be able to stop the presumed short circuit current, whose value must be determined in function of system features.

The power cables and the protection cable section must be defined in accordance with the characteristics of the protections adopted.

All electrical operations should be performed by trained personnel having the necessary requirements by the regulations in force and being informed about the risks relevant to these activities.

Operate in compliance with safety regulations in force.

Electrical data

The serial number label reports the unit specific electrical data, included any electrical accessories.

The electrical data indicated in the technical bulletin and in the manual refer to the standard unit, accessories excluded.

Refer to the electrical data report on the serial number label:

- Tensione
- F.L.A.: full load ampere, absorbed current at maximum admitted conditions
- F.L.I.: full load input, full load power input at max. admissible condition
- Electrical wiring diagram Nr

Connections

refer to the unit electrical diagram (the number of the diagram is shown on the serial number label).

verify that the network has characteristics conforming to the data shown on the serial number label.

Before starting work, verify that the sectioning device at the start of the unit power line is open, blocked and equipped with cartel warning.

Primarily you have to realize the earthing connection.

Shelter the cables using adequate measure fairleads.

Before power the unit, make sure that all the protections that were removed during the electrical connection work have been restored.

Power supply network requirements

- 1 The short circuit capacity of the line must be less than 15 kA
- 2 The units can only be connected to TN, TT distribution systems
- 3 Voltage 400-3-50 +/-10%
- 4 Phase unbalance < 2%
- 5 Harmonic distortion less than 12% (THDv<12%)
- 6 Voltage interruptions lasting no longer than 3ms and with at least 1 s between each one
- 7 Voltage dips not exceeding 20% of the RMS value, lasting no longer than a single period (50Hz) and with at least 1 s between each dip.
- 8 Earth cable as specified in the table:

Cross-section of the line conductors (mm ²)	Minimum cross-section of the protective conductor (PE) (mm ²)
$S \leq 16$	S
$16 < S \leq 35$	16
$S > 35$	S/2

Signals / data lines

Do not overpass the maximum power allowed, which varies, according to the type of signal.

Lay the cables far from power cables or cables having a different tension and that are able to emit electromagnetic disturbances.

Do not lay the cable near devices which can generate electromagnetic interferences.

Do not lay the cables parallel to other cables; cable crossings are possible, only if laid at 90°.

Connect the screen to the ground, only if there aren't disturbances.

Guarantee the continuity of the screen during the entire extension of the cable.

Respect impedance, capacity and attenuation indications.

Power input

Fix the cables: if vacated may be subject to tearing.

The cable must not touch the compressor and the refrigerant piping (they reach high temperatures).

Remote ON-OFF

Do not perform short On Off cycles

Do not use the remote On Off with thermoregulation function.

Remote ON-OFF

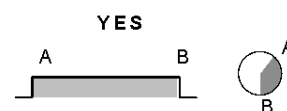

Connections performed by customer

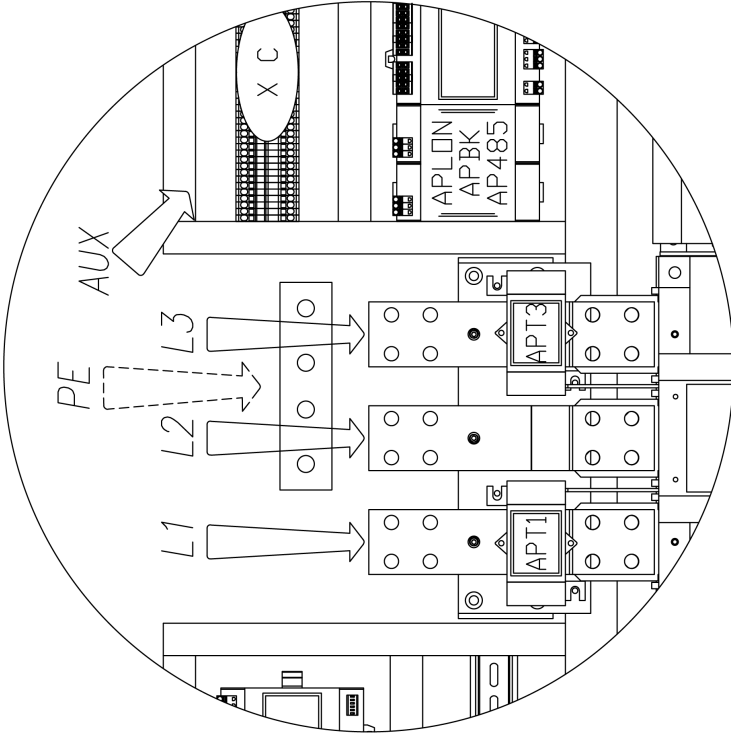

HLC1-HLC2	lampada di segnalazione stato compressore Signal lampe Verlichtingsstand lampara de señalización estado compresor	QMP	interuttore automatico a protezione pompa, circuito automatico, interrupteur automatique de protection pompe, rearmacion automatica, Schalterschutz der Umfuhlpumpe, interruptor automatico de proteccion bomba rearmacion
KMI	contattore di iniezione esterne circ. idr. / hydraul contacteur d'injection exterieure circ. hydraulique contactor de inieccion externa circ. hidr.	KMP	contattore pompa di circolazione evaporatore evaporator pump circulator contactor Schaltgeber Koffesserpumpe
ALM	segnalazione blocco cumulativo Signalmeldung señalización bloque acumulativo	KMPS	contattore di comando pompa lato sorgente C1 C1 source pump control contactor Schaltgeber Pumpensteuerung auf Quelleseite C1 contactor de accionamiento bomba lado fuente C1
SA1	selettore on/off remoto selektor ON/OFF Fernparé Fermalschalter Ein/Aus selector on/off remoto	QMS	
SA1.1	selettore abilitazione secondo set-point second set-point enabling switch Wahlschalter 2. Sollwert selector habilitación segundo set-point	AP18	demand-limit demand-limit demand-limit demand-limit
SA2.1	selettore remoto di abilitazione compressore remote compressor enabling selector Fermalschalter Fernkompressor selector remoto de habilitación compresor	AP19	Water reSet Water reSet Water reSet Water reSet
SA3.1	selettore remoto di abilitazione compressore remote compressor enabling selector Fermalschalter Fernkompressor selector remoto de habilitación compresor	APUI	valvola modulante lato sorgente C1
SA5	selettore remoto "estate/Inverno" remote winter/summer selector Fermalschalter Winter/Sommer selector remoto verano/Inverno	APSI	valvola modulante lato sorgente C1 modulating valve source side C1 Kegelventil LZ-Quersseite C1 valvula modulante lado alimentación C1
SQ1	flussostatico flow switch de 463t Strömungswächter Flusstab		
SQ2	Flussstatisco scambiatore lato sorgente C1 Source side exchanger flow switch C1 Controlador de caudales intercambio lado fuente C1 Flusstatischer Wächter des Wärmegleichers auf Quelleseite C1 Flujostabó cambiador lado fuente C1		

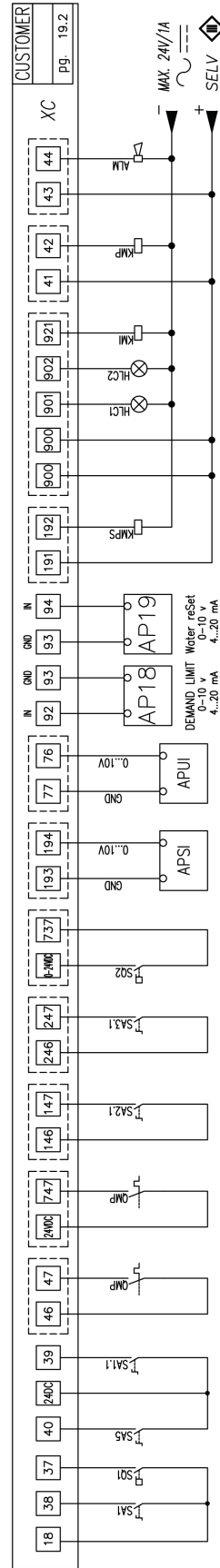

Power supply cables section

	120.1	160.1	200.1	220.1	240.1	270.1	290.1
MIN. CABLE SECTION CU (MM ²)	1 x 95	1 x 95	1 x 150	1 x 240	1 x 240	2 x 150	2 x 150
MAX. CABLE SECTION CU (MM ²)	1 x 185	1 x 185	1 x 240	1 x 240	1 x 240	2 x 300	2 x 300
MIN. BAR CU SECTION (MM ²)	nd	nd	nd	nd	nd	2x30x5	2x30x5
MAX. BAR CU WIDTH (MM)	32.0	32.0	32.0	40.0	40.0	50.0	50.0
TIGHTENING TORQUE (NM)	20.0	20.0	20.0	20.0	20.0	20.0	20.0

	250.2	280.2	320.2	360.2	400.2	480.2	540.2
MIN. CABLE SECTION CU (MM ²)	1 x 240	2 x 150	2 x 150	2 x 185	2 x 240	2 x 240	nd
MAX. CABLE SECTION CU (MM ²)	1 x 240	2 x 300	2 x 300	2 x 300	4 x 185	4 x 185	4 x 185
MIN. BAR CU SECTION (MM ²)	nd	2x30x5	2x30x5	2x40x5	2x50x5	2x50x5	2x60x5
MAX. BAR CU WIDTH (MM)	40.0	50.0	50.0	63.0	63.0	63.0	63.0
TIGHTENING TORQUE (NM)	20.0	20.0	20.0	nd	nd	nd	nd

Computer connection

Configure P.C.

- 1 connect P.C. and main module with LAN cable
- 2 check in the taskbar that the connection is active
- 3 open Control Panel and select Network and sharing center
- 4 select Modify board setting
- 5 select Local area connection (LAN)
- 6 select Internet protocol version 4 (TCP) IPV4 and enter Property
- 7 set the IP address 192.168.1.100
- 8 set Subnet mask as 255.255.255.0
- 9 confirm (OK)
- 10 enter Start (Windows button)
- 11 write the command cmd and enter/do it
- 12 write and run the command Ping 192.168.1.42
- 13 the message, connection is OK, will appear when successful
- 14 enter the browser (Chrome, Firefox ecc)
- 15 write and run the command http://192.168.1.42
- 16 Userid = WEB
- 17 Password = SBTAdmin!

- 1 Service keypad
- 2 RJ45: standard connection
- 3 P.C.-not supplied
- 4 P.C. connection, shift RJ45 from T-HI to T-IP

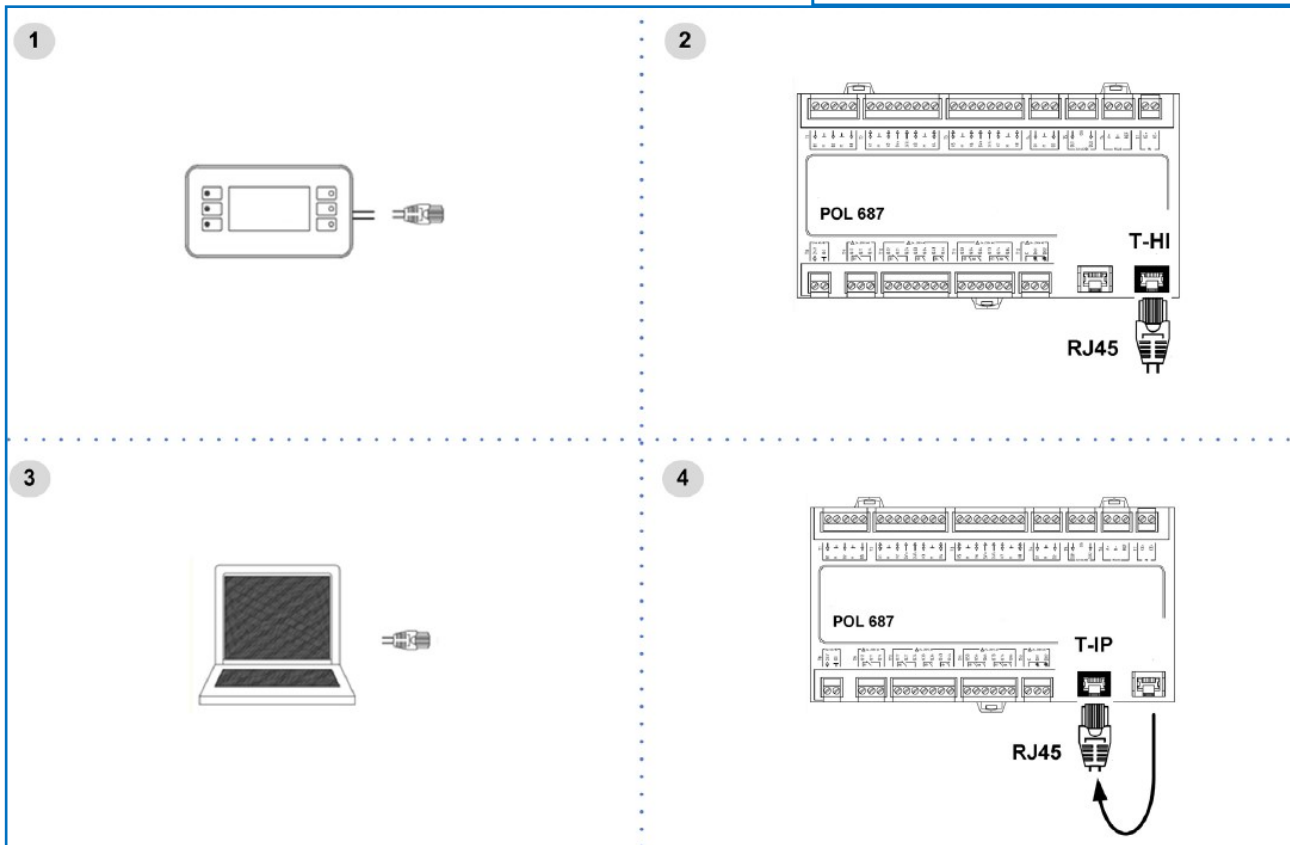

Remote Control

Option

- 1 Distance up to 350 mt
- 2 Distance up to 700 mt

- A User interface
- B=B1 KNX bus, max 350 mt
twisted pair with shield, \varnothing 0,8 mm
EIB/KNX cable marking recommended
- C PSX - Mains power supply unit
power supply unit N125/11 5WG1 125-1AB11
- C1 AC 120...230V, 50...60Hz
- D KNX bus, max 350 mt

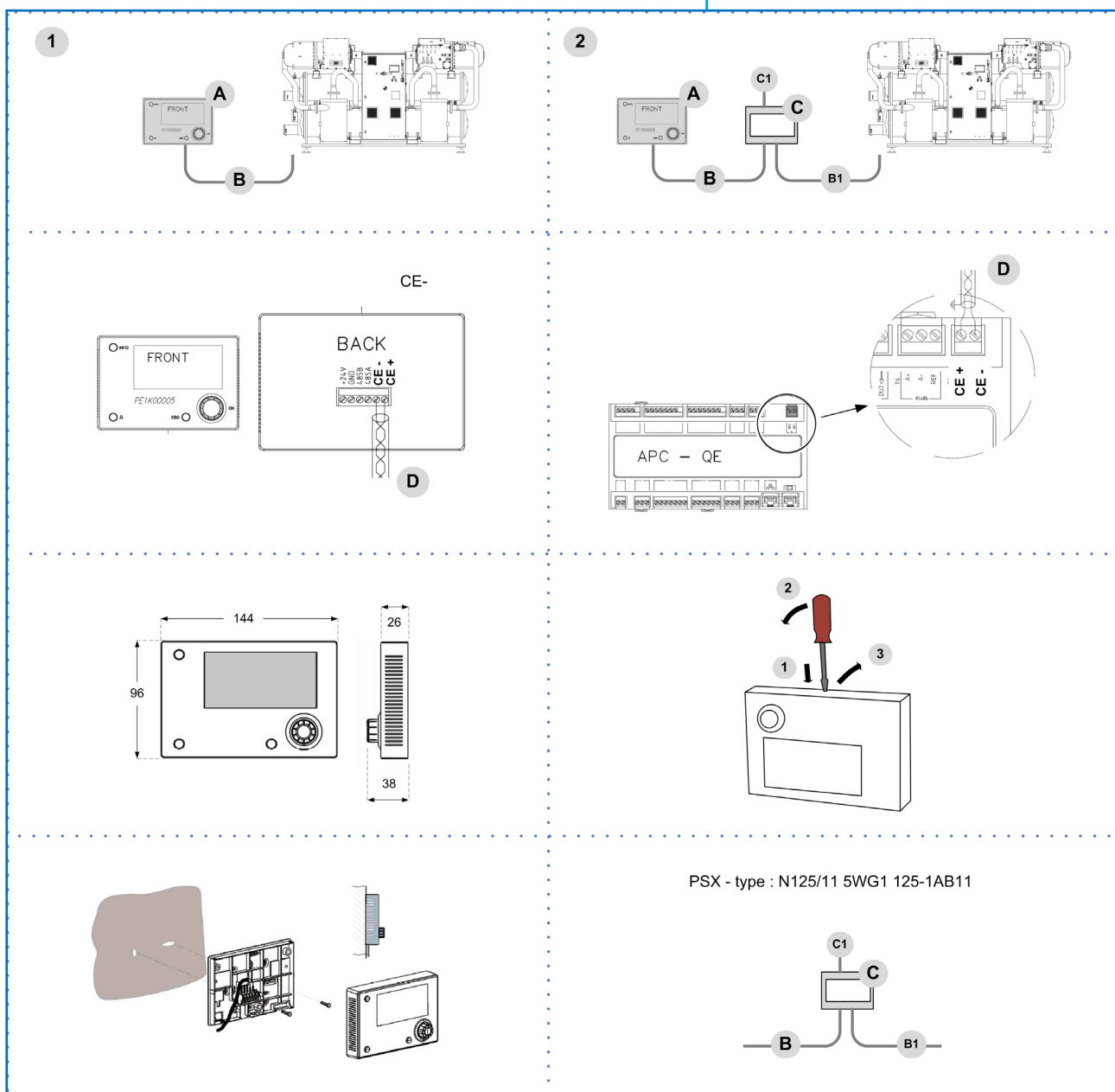

Modbus - RS485 Option

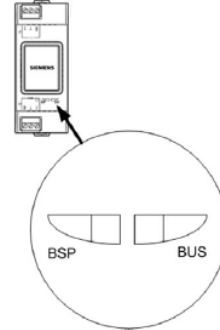
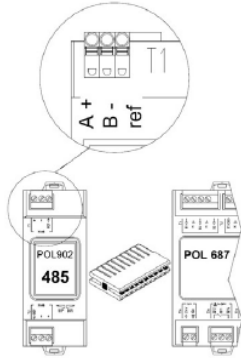

LED BSP	communication with AP1 module	LED BUS	communication with Modbus
green	communication ok	green	communication ok
yellow	software ok but communication with AP1 down	yellow	startup / channel not communicating
red	flashing: software error fixed: hardware error	red	communication down

Modbus / LonWorks / Cable requirements

Couple of conductors twisted and shielded
Section of conductor 0,22mm²...0,35mm²
Rated power between conductors $\leq 50 \text{ pF/m}$
Nominal impedance 120 Ω

Recommended cable BELDEN 3106A

- very RS485 serial line must be set up using the 'In/Out' bus system.
- Other types of networks are not allowed, such as Star or Ring networks.
- The difference in potential between the earth of the two RS485 devices that the cable shielding needs to be connected to must be lower than 7 V
- There must be suitable arresters to protect the serial lines from the effects of atmospheric discharges
- A 120 ohm resistance must be located on the end of the serial line. Alternatively, when the last serial board is equipped with an internal terminator, it must be enabled using the specific jumper, dip switch or link.
- The cable must have insulation features and non-flame propagation in accordance with applicable regulations.
- The RS485 serial line must be kept as far away as possible from sources of electromagnetic interference.

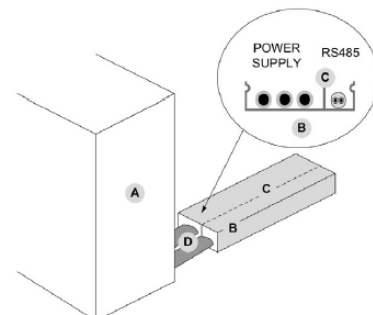

- A. Unit
- B. Metal conduit
- C. Metal septums
- D. Metal-lined sheath (sleeve)

LonWorks - Option

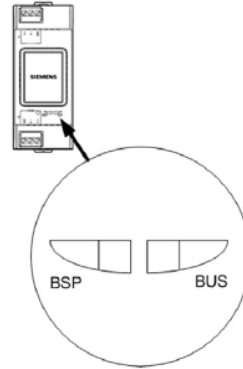

LED BSP	communication with AP1 module	LED BUS	communication with LonWorks
Green	communication ok	Green	ready for communication
Yellow	software ok but communication with AP1 down	Yellow	startup
Red	flashing: software error fixed: hardware error	Red	flashing: communicating not possible communication ok

LONWORK CABLE TYPE

Echelon allows three cable types for channel type TP/FT-10, including the Category 5 network cable used commonly in building automation and control (TIA 568A Cat-5).

CAT-5 SPECIFICATIONS

Unshielded cable, twisted pair with at least 18 beats per meter:

- Cross-sectional area min ϕ 0,5mm²

- impedance 100 +/- 15% @ f > 1 MHz

BACnet IP - Option

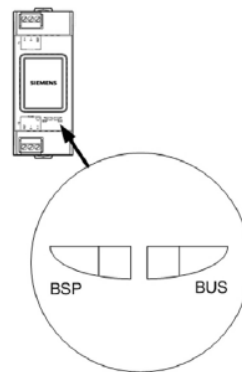
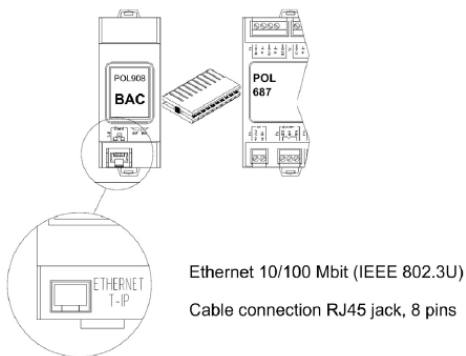

LED BSP	communication with AP1 module	LED BUS	communication with BACnet
Green	communication ok	Green	ready for communication
Yellow	software ok but communication with AP1 down	Yellow	startup
Red	flashing: software error fixed: hardware error	Red	BACnet server down fixed: hardware error restart after 3 sec

Ecoshare

Option

Control of the network is entrusted to the Master unit (identified by the parameter LNAddress = 1).

The network can be extended up to a maximum of 8 units (1 master – 7 slaves).

The master arranges for managing connected units in order to obtain:

- The coordination of the operation (Mode commands, status, setpoint and signal of the DemandLimit function are propagated from the Master unit to the Slaves).
- The rotation of the operating priorities of the machines based on their wear (total number of hours of operation).
- The management of one or more units in standby. The units put on standby are always the ones showing more wear. The units on standby are rotated with daily frequency or when an alarm is triggered on the units in operation .

Connection requirements

- Maximum length of the bus line: 700 m.
- Maximum distance between 2 units: 300 m.
- Type of cable: shielded twisted pair cable Ø 0,8 mm. use an EIB/KNX cable
- Possible connections: Tree, star, in/out bus, mixed
- It is not possible to use a ring connection
- No end-of-line resistor or terminator required
- There must be suitable arresters to protect the serial lines from the effects of atmospheric discharges
- The data line must be kept separate from the power conductors or powered at different voltage values and away from possible sources of electrical interference

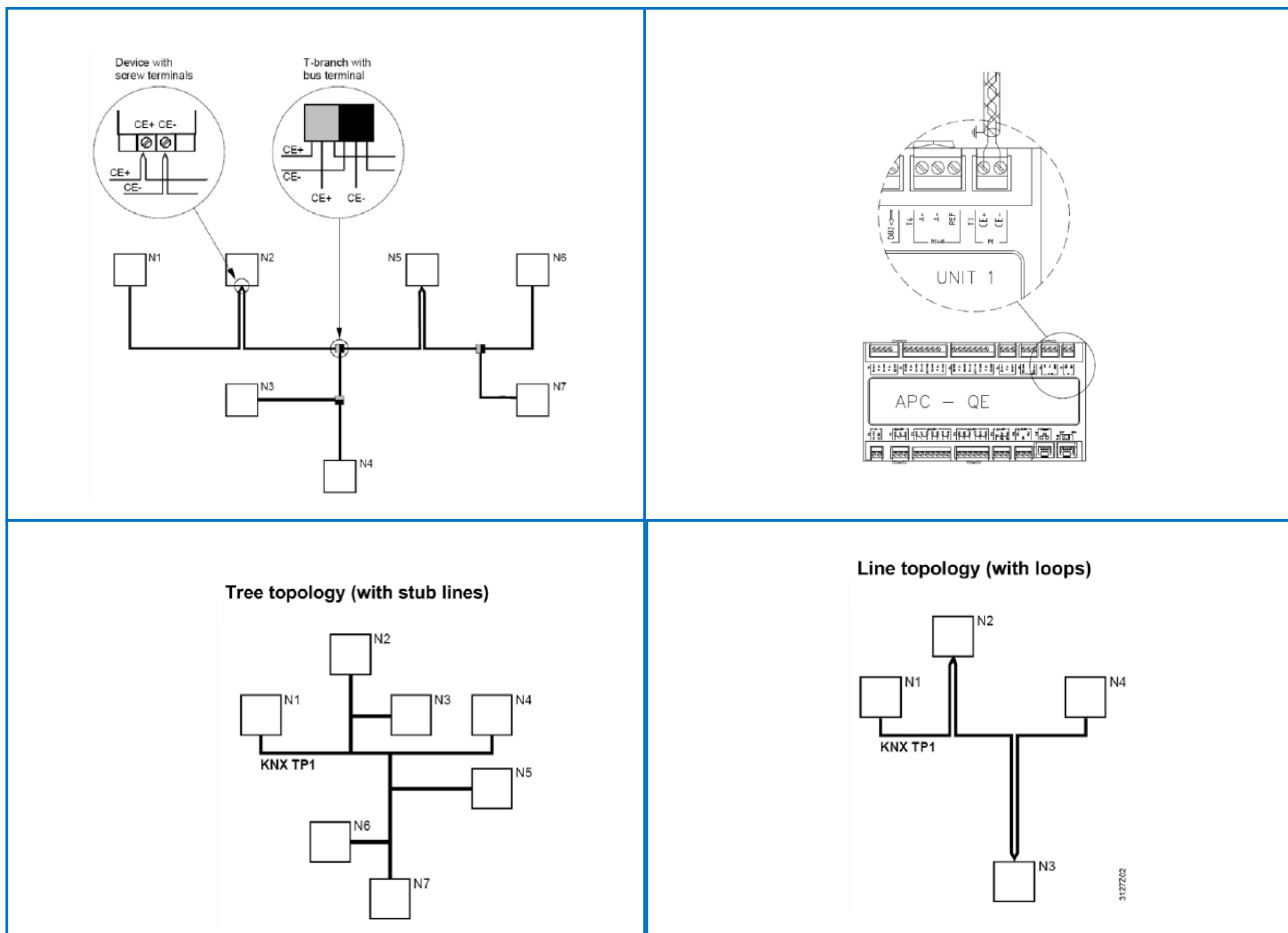

7 START-UP

General

⇒ *The indicated operations should be done by qualified technician with specific training on the product.*

The electrical, water connections and the other system works are by the installer.

Agree upon in advance the start-up data with the service centre.

Agree upon in advance the star-up data with the service centre.

For details, refer to the various chapters in the manual.

Before checking, please verify the following:

- the unit should be installed properly and in conformity with this manual
- the electrical power supply line should be sectioned at the beginning.
- The line sectionalizing device is open, locked and equipped with the suitable warning
- make sure no tension is present

WARNING

⇒ *After turning off the power, wait at least 10 minutes before accessing to the electrical panel or any other electrical component.*

⇒ *Before accessing check with a multimeter that there are no residual stresses*

⇒ *Do not power the unit with empty water side exchangers. Possible damage to anti-freeze electric heaters.*

Preliminary checks

Unit OFF power supply

		Yes / No
1	safe access	
2	suitable frame to withstand unit weight + people weight	
3	functional clearances	
4	structure integrity	
5	unit on vibration isolators	
6	the unit must be level.	
7	unit input water filter + shut-off valves for cleaning	
8	vibration dampeners on hydraulic connections	
9	expansion tank (recommended volume = 10% system content)	
10	minimum system water content	
11	clean system	
12	loaded system + possible glycol solution + corrosion inhibitor	
13	system under pressure + vented	
14	refrigerant circuit visual check	
15	earthing connection	
16	power supply features	
17	Customer care connections: electrically connected, configured	

Start-up sequence

Unit power supply ON



Before powering the unit carry out a leak test with suitable instrumentation

		Yes / No
1	compressor carter resistances operating at least since 8 hours	
2	off-load voltage measure	
3	phase sequence check	
4	pump manual start-up and flow check	
5	refrigeration circuit shut-off valves opening (if applicable)	
6	unit ON	
7	load voltage measure	
8	verify the lack of bubbles in the liquid light (if applicable)	
9	measure of return and supply water temperature	
10	super-heating and sub-cooling measure	
11	check no anomalous vibrations are present	
12	set-point personalization	
13	scheduling customisation	
14	complete and available unit documentation	

Cooling circuit

- 1 Visually inspect the refrigerating circuit: the presence of oil stains can be a symptom of leakage (caused e.g. by transportation, handling or other).
- 2 Verify that the refrigerating circuit is in pressure: Using the unit manometers, if present, or service manometers.
- 3 Make sure that all the service outlets are closed with proper caps; if caps are not present a leak of refrigerant can be possible.
- 4 Open all of the refrigeration circuit shut-off valves (if applicable).

Hydraulic circuit

- 1 Before connecting the unit to the hydraulic system, make sure that the hydraulic system has been washed and that the water has been drained
- 2 Check that the hydraulic circuit has been filled and pressurized-
- 3 Check that the shut-off valves in the circuit are in the "OPEN" position.
- 4 Check that there is no air inside the circuit, and bleed it through the vent valves in the high points of the system if necessary.
- 5 When using antifreeze solutions, make sure the glycol percentage is suitable for the type of use envisaged.

NOTE

⇒ *Neglecting the washing will lead to several filter cleaning interventions and at worst cases can cause damages to the exchangers and the other parts.*

Electric circuit

Check the unit is connected to the earthing system.

Check the conductors are tightened as: the vibrations caused by handling and transport might cause these to come loose.

Power the unit by closing the isolation device but leave in OFF.

Check the network frequency and voltage values, which must be within the limits: 400-3-50 +/-10%

Check and adjust the phase balance as necessary: it must be lower than 2%

NOTE

⇒ *Working outside of these limits can cause irreversible damages and voids the warranty.*

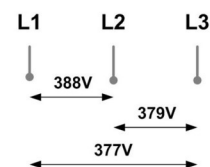

$$1) \frac{388 + 379 + 377}{3} = 381 \text{ (A)}$$

$$2) \text{MAX} - A = 388 - 381 = 7$$

$$3) S = \frac{7}{A} \times 100 = 1,83 \text{ OK}$$

Voltage

Check that the air and water temperatures are within in the operating limits.

Start-up the unit.

While the unit is operative, i.e. in stable conditions nearing operating ones, check:

- Power supply voltage
- Total absorption of the unit
- Absorption of the single electric loads

Options

Menu accessible only after having entered the password. Access reserved only to specifically trained personnel.

The parameter modification can cause irreversible damages.

Path: Main menu / Unit parameters / Options

Parameters	Short description	Description
P0050	En Demand limit	Enabling Demand Limit: 0 = disabled, 1 = analogic input, 2 = parameter
P0051	En Water reset	Enabling Water reset: 0 = Off, 1 = Cool, 2 = Heat, 3 = Cool and Heat
P0052	En 2SetPoint	Enabling 2SetPoint: 0 = Off, 1 = On
P0053	En Climatica	Enabling Climatic 0 = Off, 1 = Cool, 2 = Heat, 3 = Cool and Heat
P0054	PrioritaCmd	Status and machine mode priority: Local [0] = Priority to local commands, BMS [1] priority to commands from plant supervisor
P0055	En DI On-Off	Enabling remote ON-OFF: 0 = Off, 1 = On
P0061	Enable scheduler	Enable scheduler : 0 = Off, 1 = On
P0062	TypeDL	Inlet signal type: 0 = 0-10V; 1 = 4-20mA
P0063	TypeWR	Inlet signal type: 0 = 0-10V; 1 = 4-20mA

Demand limit

Menu accessible only after having entered the password.

⇒ Access reserved only to specifically trained personnel.

⇒ The parameter modification can cause irreversible damages.

It is possible to limit the absorbed electric power with an external signal 0-10 Vcc or 4-20mA. The higher the signal is, the lower the number of compressors available to meet the thermal need.

Only if P0002 En DemandLimit ≠ 0

Path: Main menu / Unit parameters / Options

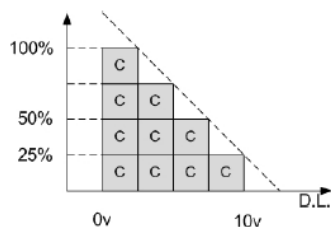

Step	Action	Menu/Variable	Keys		Display
1	Press 3 sec.		✓		Password
2	Set	Password	▲	✓	
3	Press		i		Main menu
4	Select	Unit parameters	▼	✓	Unit parameters
5	Select	Set Point	▼	✓	Set Point
6	Select	Demand limit	▼	✓	
7	Set	Demand limit	▲	▼	
8	Confirm		✓		
9	Press 3 sec.		⏏		
10	Select	Local connections	✓		

Path: Main menu / Unit parameters / Options

Parameters	Short description	Description
P0062	TypeDL	Inlet signal type: 0=0-10V; 1=4-20mA

Path: Main Menu / Unit parameters / Setpoint

P0009	set demand limit	Parameter setting of the value % of demand limit
-------	------------------	--

Climatica TExt

Menu accessible only after having entered the password.

⇒ Access reserved only to specifically trained personnel.

⇒ The parameter modification can cause irreversible damages.

The setpoint based on the climatic curve and the Water Reset is displayed on the display

Only if P0053: En Climatica = 1

Path: Main menu / Unit parameters / Options



Step	Action	Menu/Variable	Keys		Display
1	Press 3 sec.		✓		Password
2	Set	Password	▲	✓	
3	Press		i		Main menu
4	Select	Unit parameters	▼	✓	Unit parameters
5	Select	Climatic TExt	▼	✓	Climatic TExt (pwd)
6	Select	Parameter	▼	✓	
7	Set		▼	▲	
8	Confirm		✓		
9	Press 3 sec.		🔒		
10	Select	Local connections	▼	✓	

Path: Main menu / Unit parameters / Climatic TExt

Parameters	Short description	Description
P0265	CSptLow	value of set Cool for outdoor air greater than P0266
P0266	AirAtSptLowC	value of outdoor air for set Cool equal to the parameter P0265
P0267	CSptHigh	value of set Cool for outdoor air lower than P0268
P0268	AirAtSptHigC	value of outdoor air for set Cool equal to the parameter P0609

Water reset

Menu accessible only after having entered the password.

⇒ Access reserved only to specifically trained personnel.

⇒ The parameter modification can cause irreversible damages.

It is possible to limit the absorbed electric power with an external signal 0-10 Vcc or 4-20mA.

The setpoint based on the climatic curve and the Water Reset is displayed on the display

Only if P0051: En WaterReset = 1

Path: Main menu / Unit parameters / Options

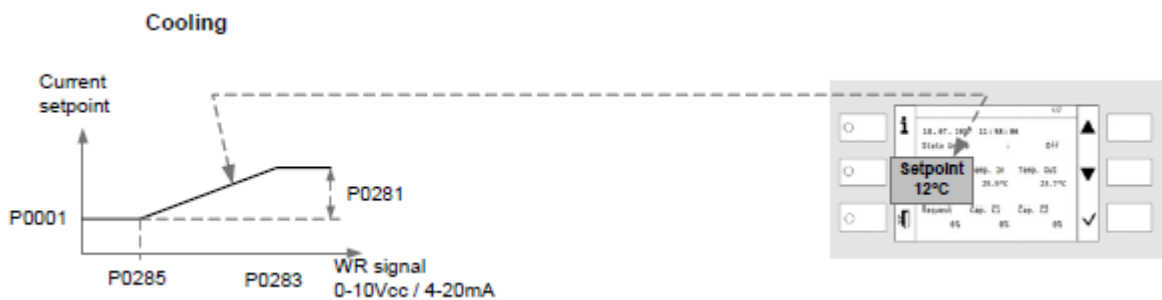

Step	Action	Menu/Variable	Keys		Display
1	Press 3 sec.		✓		Password
2	Set	Password	▼	✓	
3	Press		i		Main menu
4	Select	Unit parameters	▼	✓	Unit parameters
5	Select	Water reset	▼	✓	Water reset
6	Select	Parameter	▼	✓	
7	Set		▼	▲	
8	Confirm		✓		
9	Press 3 sec.		⏏		
10	Select	Local connections	✓		

Path: Main menu / Unit parameters / Options

Parameters	Short description	Description
P0063	TypeWR	Inlet signal type: 0=0-10V; 1=4-20mA

Path: Main Menu / Unit parameters / Water reset

P0281:	MaxCWRC	Maximum correction to be applied to the setpoint
P0283	SWRMaxC	Value of the WR control signal corresponding to the correction of the set COOL equal to the parameter P0281
P0283	SWRMinC	Value of the WR control signal corresponding to the correction of the set COOL equal to 0

Reduced load operation

The units are equipped with inverter and can therefore operate with reduced loads.

However, a constant and prolonged operation with reduced load with frequent compressor(s) stops and start-ups can cause irreparable damages due to the absence of oil return.

The above-described operating conditions must be considered outside the operating limits.

In the event of a compressor breakdown due to operating in the above-mentioned conditions, the warranty shall not be valid and Clivet spa declines any responsibility.

Periodically check the average operating times and frequency of compressor start-ups: indicatively the minimum thermal load must be such as to require a compressor to operate for at least ten minutes.

If the average times are close to this limit, take the proper corrective actions, for example, increasing the water content of the system is not enough in this application.

Check the water flow-rate of the evaporator

Check that the difference between the temperature of the exchanger's input and output water corresponds to the potential according to this formula:

- $\text{unit cooling power (kw)} \times 860 = \text{Dt (}^\circ\text{C)} \times \text{flow rate (L/h)}$

The cooling power is shown in the GENERAL TECHNICAL DATA chart included in this manual, referred to specific conditions, or in the COOLING PERFORMANCE charts in the TECHNICAL BULLETIN referred to various conditions of use.

Check for water side exchanger pressure drops:

- determine the water flow-rate
- measure the difference in pressure between the exchanger's input and output water and compare it with the WATER-SIDE EXCHANGER PRESSURE DROPS chart

Measuring the pressure is easier if pressure gauges are installed as indicated in the DIAGRAM OF SUGGESTED WATER CONNECTIONS.

Start-up report

To detect the objective operational conditions is useful to control the unit over time.

With unit at steady state, i.e. in stable and close-to-work conditions, identify the following data:

- total voltages and absorptions with unit at full load
- absorptions of the different electric loads (compressors, fans, pumps etc)
- temperatures and flows of the different fluids (water, air) both in input and in output from the unit
- temperatures and pressures in the feature points of the cooling circuit (compressor, liquid, suction drain/unload)

The detections must be kept and made available during maintenance interventions.

Directive 2014/68EU PED

Directive 2014/68EU PED also sets out the regulations for unit installers, users and maintenance operators.

Refer to local regulations; briefly and as an example, see the following:

Compulsory verification of the first installation:

- only for units assembled on the installer's building site (for ex. condensing circuit + direct expansion unit)

Commissioning declaration:

- for all units

Periodical checks:

- to be executed with the frequency indicated by the Manufacturer (see the “maintenance inspections” paragraph)

8 CONTROL

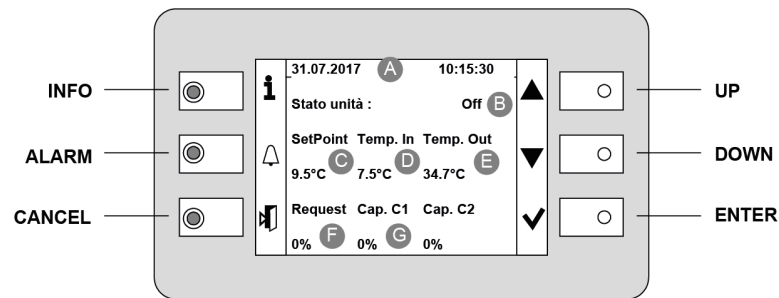

Led

INFO	Not used
ALARM	Blink / fixed = alarm present
CANCEL	not used currently







Display

Ref.	Variable	description
A		Date - Time
B	Current state	On / off / eco / pmp On
C	SetPoint	Adjustment temperature
D	Temp. IN	Water inlet temperature utility side
E	Temp. OUT	Water outlet temperature utility side
F	Request	Power requested by thermoregulator (including any limitation from Demand Limit)
G	Cap. C1	Power capacity delivered by the compressor 1
	Cap. C2	Power capacity delivered by the compressor 2

Keys











Symbol	Name	description
	Info	Main menu
	Alarm	Alarm display
	Cancel	Exit Previous level Keyboard settings
	Up	Increases value
	Down	Decreases value
	Enter	Confirm Password

Change unit state

Step	Action	Menu/Variable	Keys		Display
1	Press				Main menu
2	Select	Cmd Local state			
3	Set	OFF - ECO - ON - Pump On			
4	Confirm				
6	Exit				

STATE	
ON	Compressors enabled
OFF	Compressors disabled
	Antifreeze protection user side active
ECO	Compressors enabled
	Pumps activated periodically
	Setpoint = SetPoint ECOCool
Pmp_On	Compressors disabled
	Pumps running

Modify setpoint

Step	Action	Menu/Variable	Keys		Display
1	Press				Main menu
2	Select	Unit parameters			Unit parameters
3	Confirm	Set Point			
4	Select	Set Point			
5	Set	Set Point			
6	Confirm				
7	Exit				

Parameters	Short description	Description
P0001	SetPointCooling	Setpoint Cool
P0003	2SetPointCooling	2° Setpoint Cool - enable by remote switch
P0005	SetPointECOCooling	Economic Cool setpoint

Display the status

Step	Action	Menu/Variable	Keys		Display
1	Press				Main menu
2	Select	Machine State			
3	Select	General, circuit, ecc..			
4	Exit				

Scheduler

It is possible to set 6 events (Off, Eco, On, Recirculating) for each week day.

Step	Action	Menu/Variable	Keys		Display
1	Press				Main menu
2	Select	Scheduler			Scheduler
3	Select	Day			
4	Select	Time			
5	Set	Event time			
6	Confirm				
7	Select	Value			
8	Set	On/Eco..			
9	Confirm				
10	Exit				

Enable Scheduler

Step	Action	Menu/Variable	Keys		Display	Notes
1	Press 3 sec.				Password	
2	Set	Password				
3	Press				Main menu	*
4	Select	Unit Parameters				
5	Select	Option config				
6	Set	P0061=1				
7	Press 3 sec.					
	Select	Local connections				

* Unit Parameters menu is displayed

Keyboard settings

Step	Action	Menu/Variable	Keys		Display
1	Press 3 sec.				
2	Press				HMI Settings
3	Select				
4	Press				
5	Press				
6	Select	Local connections			

Alarms

- Before resetting an alarm identify and remove its cause.
Repeated resets can cause irreversible damage.
Display of alarm: step 1-3
Reset allarm: step 4-10
Example:
+ eE001: Monitore fase: Fault = active alarm
- EE003: Guasto P1 Util: Ok = resetted alarm

Step	Action	Menu/Variable	Keys		Display
1	Press				Alarm list detail
2	Press				Alarm list
3	Select	Alarm			Alarm list detail
4	Press 3 sec.				Password
5	Set	Enter password			Alarm list detail
6	Press				Alarm list
7	Select	Alarm			
8	Select	Reset Executed			
9	Press 3 sec.				
10	Select	Log off			

General list of alarms

The alarm code identifies the concerned circuit:

Example:

ee 1 01:TimeOutModCirc = circuit 1

ee 2 01:TimeOutModCirc = circuit 2

Code	Alarm type
ee, ff, ii	automatic reset
eE, fF, iI	automatic reset (after N intervention the alarm becomes manual reset)
EE, FF, II	manual reset

Alarm list - 1

ID	Description
ce1108	Critical. Inverter in critical overload status
ce1111	Critical. Inverter in critical unvoltage status
ce1112	Critical. Inverter in critical over-temperature status
ce1116	Critical. Main CPU HW error
ce1117	Critical. Temperature sensor error
ce2108	Critical. Inverter in critical overload status
ce2111	Critical. Inverter in critical unvoltage status
ce2112	Critical. Inverter in critical over-temperature status
ce2116	Critical. Main CPU HW error
ce2117	Critical. Temperature sensor error
cf1102	Critical. Compressor envelope in critical area
cf1105	Critical. Critical oil level
cf1107	Critical. Motor in critical temperature
cf2102	Critical. Compressor envelope in critical area
cf2105	Critical. Critical oil level
cf2107	Critical. Motor in critical temperature
eE0001	Phase monitor in alarm mode
EE0003	Thermal protection of utility pump 1 active
EE0004	Thermal protection of utility pump 2 active
EE0005	Thermal protection of utility pump 3 active
eE0008	Utility pump inverter alarm
ee0010	Master disconnected on eco share network
ee0011	Slave 2 on eco share network in generic alarm mode
ee0012	Slave 2 disconnected on eco share network
ee0013	Slave 3 on eco share network in generic alarm mode
ee0014	Slave 3 disconnected on eco share network
ee0015	Slave 4 on eco share network in generic alarm mode
ee0016	Slave 4 disconnected on eco share network
ee0017	Slave 5 on eco share network in generic alarm mode
ee0018	Slave 5 disconnected on eco share network
ee0019	Slave 6 on eco share network in generic alarm mode
ee0020	Slave 6 disconnected on eco share network
ee0021	Slave 7 on eco share network in generic alarm mode
ee0022	Slave 7 disconnected on eco share network
ee0027	Faulty utility inlet water sensor
ee0028	Faulty utility outlet water sensor
ee0029	Faulty outdoor air sensor
ee0030	Faulty analogue input for demand limit (0-10V)
ee0031	Faulty analogue input for water reset (0-10V)
ee0033	Faulty electrical panel sensor
ee0034	Faulty second electrical panel temperature sensor
ee0035	Faulty recovery inlet water sensor
ee0036	Faulty recovery outlet water sensor
ee0037	Faulty recovery water differential pressure transducer
ee0038	Faulty analogue input for recovery water reset (0-10V)
ee0039	Faulty analogue input for recovery water reset (4-20mA)
ee0040	Faulty source inlet water sensor
ee0041	Faulty source outlet water sensor
ee0042	Faulty source water differential pressure transducer
ee0050	Faulty utility water differential pressure transducer

Alarm list - 2

ID	Description
EE0054	Recovery pump 1 thermal protection active
EE0055	Recovery pump 2 thermal protection active
EE0056	Recovery pump 3 thermal protection active
eE0057	Recovery pump inverter alarm
EE0060	Source pump 1 thermal protection active
eE0061	Source pump inverter alarm
ee0100	Communication error between 98U1 expansion module and POL687
ee0101	Communication error between 98U2 expansion module and POL687
ee0110	Communication error between 98U3 expansion module and POL687
ee0130	Faulty analogue input for demand limit (4-20mA)
ee0131	Faulty analogue input for water reset (4-20mA)
ee1001	Faulty TEV3 suction temperature sensor
ee1002	Faulty TEV5 suction temperature sensor
ee1003	Faulty liquid intake pressure transducer
ee1004	Locked electronic valve
ee1005	Locked electronic valve
EE1006	Compressor protection
ee1011	Locked electronic valve
EE1018	Source fan thermal protection active
ee1027	Faulty suction temperature sensor
ee1028	Faulty condensation pressure transducer
ee1029	Faulty intake pressure transducer
ee1039	No ModBus communication between POL_687 and the inverter of circuit 1
ee1070	Fault on physical driver of electronic valve
ee1071	Fault on physical driver of electronic valve
ee1077	Fault on physical driver of electronic valve
ee1101	Fault. Faulty power supply network
ee1106	Fault. Motor in overload protection
ee1108	Fault. Inverter in overload protection
ee1109	Fault. Inverter in overcurrent
ee1110	Fault. Inverter in overvoltage
ee1111	Fault. Inverter in undervoltage
ee1112	Fault. Inverter in over-temperature
ee1113	Fault. Inverter in HW configuration error
ee1114	Fault. Inverter in SW configuration error
ee1115	Fault. Compressor motor parameter configuration error
ee1116	Fault. Main CPU HW error
ee1117	Fault. Temperature sensor error
ee1118	Liquid temperature sensor
ee1139	No ModBus communication between POL_687 and the inverter of circuit 1 for address configuration procedure
ee2001	Faulty TEV4 suction temperature sensor
ee2002	Faulty TEV6 suction temperature sensor
ee2003	Faulty liquid intake pressure transducer
ee2004	Locked electronic valve
ee2005	Locked electronic valve
EE2006	Compressor protection
ee2011	Locked electronic valve
EE2018	Source fan thermal protection active
ee2027	Faulty suction temperature sensor
ee2028	Faulty condensation pressure transducer

Alarm list - 3

ID	Description
ee2029	Faulty intake pressure transducer
ee2039	No ModBus communication between POL_687 and the inverter of circuit 2
ee2070	Fault on physical driver of electronic valve
ee2071	Fault on physical driver of electronic valve
ee2077	Fault on physical driver of electronic valve
ee2101	Fault. Faulty power supply network
ee2106	Fault. Motor in overload protection
ee2108	Fault. Inverter in overload protection
ee2109	Fault. Inverter in overcurrent
ee2110	Fault. Inverter in overvoltage
ee2111	Fault. Inverter in undervoltage
ee2112	Fault. Inverter in over-temperature
ee2113	Fault. Inverter in HW configuration error
ee2114	Fault. Inverter in SW configuration error
ee2115	Fault. Compressor motor parameter configuration error
ee2116	Fault. Main CPU HW error
ee2117	Fault. Temperature sensor error
ee2118	Liquid temperature sensor
ee2139	No ModBus communication between POL_687 and the inverter of circuit 2 for address configuration procedure
ff0001	Refrigerant leak detector in alarm mode
ff1005	Circuit lock due to low superheating
ff1006	Circuit lock due to low superheating
ff1007	Circuit lock due to low superheating
fF1012	Low pressure from transducer in recovery mode
fF1013	High pressure from pressure switch
fF1015	High pressure from transducer
fF1017	Minimum compression ratio
fF1018	Low pressure from transducer
FF1019	Maximum compression ratio
ff1034	Circuit drained of refrigerant
FF1046	Limit of low pressure from transducer
ff1100	Fault. Too many identical temporary reset errors in 24 hours / too many timed reset errors in 1 hour
ff1102	Fault. Compressor envelope in locking area
ff1103	Fault. Envelope configuration error
ff1104	Fault. High oil temperature
ff1105	Fault. Low oil level
ff1107	Fault. Motor in over-temperature
ff1118	Fault. High and low pressure transducers outside the limits
ff2005	Circuit lock due to low superheating
ff2006	Circuit lock due to low superheating
ff2007	Circuit lock due to low superheating
fF2012	Low pressure from transducer in recovery mode
fF2013	High pressure from pressure switch
fF2015	High pressure from transducer
fF2017	Minimum compression ratio
fF2018	Low pressure from transducer
FF2019	Maximum compression ratio

Alarm list - 4

ID	Description
ff2034	Circuit drained of refrigerant
FF2046	Limit of low pressure from transducer
ff2100	Fault. Too many identical temporary reset errors in 24 hours / too many timed reset errors in 1 hour
ff2102	Fault. Compressor envelope in locking area
ff2103	Fault. Envelope configuration error
ff2104	Fault. High oil temperature
ff2105	Fault. Low oil level
ff2107	Fault. Motor in over-temperature
ff2118	Fault. High and low pressure transducers outside the limits
iI0002	Utility hydraulic pressure alarm
iI0006	User side differential pressure switch/flow alarm
II0007	User freeze alarm
ii0008	Pumps active in freeze protection
II0009	Incongruent differential between user Tin and Tout
II0010	Recovery freeze alarm
ii0011	Pumps active in recovery freeze protection
II0012	Incongruent differential between recovery Tin and Tout
II0014	Source freeze alarm
ii0015	Pumps active in source freeze protection
iI0052	Recovery side differential pressure switch/flow alarm
iI0053	Recovery hydraulic pressure alarm
iI0062	Source hydraulic pressure alarm
iI0063	Source side differential pressure switch/flow alarm

9 MAINTENANCE

Safety

Operate in compliance with safety regulations in force .
Use single protection devices: gloves, glasses, helmet etc.
usare dispositivi di protezione: guanti, occhiali, elmetto ecc.

General

Maintenance must be performed by authorized centres or by qualified personnel

The maintenance allows to:

- maintaining the unit efficient
- reduce the deterioration speed all the equipment is subject to over time
- collect information and data to understand the efficiency state of the unit and prevent possible faults

WARNING

- ⇒ *Before checking, please verify the following:*
- ⇒ *the electrical power supply line should be isolated at the beginning*
- ⇒ *the line isolator device is open, locked and equipped with the suitable warning sign*
- ⇒ *make sure no tension is present*
- ⇒ *After switching the power off, wait at least 5 minutes before accessing to the electrical panel or any other electrical component.*
- ⇒ *Before accessing check with a multimeter that there are no residual stresses.*

Frequency of interventions

Perform an inspection every 6 months.

However, frequency depends on the type of use.

Pan inspections at close intervals in the event of:

- frequent use (continuous or very intermittent use, near the operating limits, etc)
- critical use (service necessary)

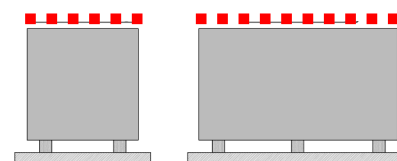
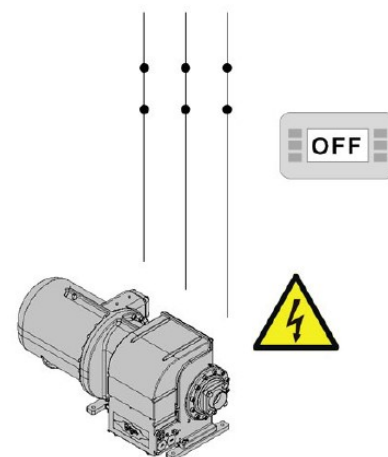
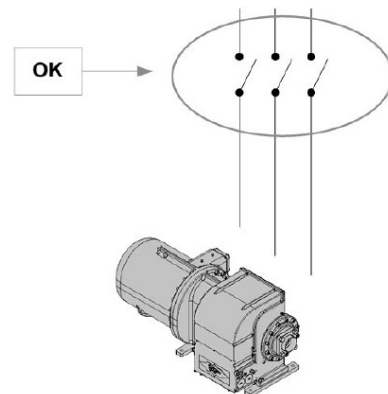

	intervention frequency (months)	1	6	12
1	Presence of corrosions			X
2	Panel fixing			X
3	Water filter cleaning		X	
4	water: quality, pH, glycol concentration		X	
5	check exchanger efficiency			X
6	circulation pump		X	
7	Check of the fixing and the insulation of the power lead			X
8	earth cable check			X
9	Electric panel cleaning			X
10	power remote controls status			X
11	clamp closure, cable isolation integrity			X
12	Voltage and phase unbalancing (no load and on-load)		X	
13	Absorptions of the single electrical loads		X	
14	compressor casing heaters test		X	
15	Checking for leaks *			*
16	cooling circuit work parameter detection		X	
17	check oil level on compressor warning light	X		
18	safety valve *			*
19	protective device test: pressure switches, thermostats, flow switches etc..			X
20	control system test: setpoint, climatic compensations, capacity stepping, air flow-rate variations			X
21	Control device test: alarm signalling, thermometers, probes, pressure gauges etc			X

NOTE

⇒ Refer to the local regulations. Companies and technicians performing installation, maintenance/repair, leak control and recovery operations must be CERTIFIED as set out by the local regulations.

Unit booklet

Foresee a unit schedule to keep trace of the interventions made on the unit.

In this way, it will be easier to adequately schedule the various interventions and facilitate any troubleshooting.

On the schedule note:

- date
- intervention description
- carried out measures etc.

Standby mode

If foreseen a long period of inactivity:

- turn off the power
- Prevent the risk of freezing (use glycol or empty the system) disconnect voltage to avoid electric risks or damages following lightning

With lower temperatures keep heaters turned on in of the electrical panel (option).

It is recommended to have a qualified technician start the system after a period of inactivity, especially after seasonal stops or for seasonal switch-overs.

When starting, follow the instructions in the “start-up” section.

Schedule technical assistance in advance to avoid hitches and to guarantee that the system can be used when required.

System drain

The system must be drained only if necessary.

Avoid draining the system periodically; corrosive phenomena can be generated.

- 1 Empty the system
- 2 empty the exchanger, use all shut-off valves and grub screws
- 3 blow the exchanger with compressed air
- 4 dry the exchanger with hot air; for greater safety, fill the exchanger with glycol solution
- 5 protect the exchanger from air
- 6 take the drain caps off the pumps

Any anti-freeze liquid contained in the system should not be discharged freely as it is a pollutant. It must be collected and reused.

Before start-up, wash the system.

It is recommended to have a qualified technician start the system after a period of inactivity, especially after seasonal stops or for seasonal switch-overs.

When starting, follow the instructions in the “start-up” section.

Schedule technical assistance in advance to avoid hitches and to guarantee that the system can be used when required.

Water side heat exchanger

The exchanger must be able to provide the maximum thermal exchange, therefore it is essential for the inner surfaces to be clean of dirt and build-up.

Periodically check the difference between the temperature of the supply water and the condensation temperature: if the difference is greater than 8°C–10°C it is advisable to clean the exchanger.

The clearing must be effected:

- with circulation opposite to the usual one
- with a speed at least 1,5 times higher than the nominal one
- do not exceed the maximum flow-rate allowed
- with an appropriate product moderately acid (95% water + 5% phosphoric acid)
- after the cleaning rinse with water to inhibit the action of any residual product

Vacuum operation - Frost risk

If it is necessary to evacuate the refrigerant, keep the water circulating in the exchangers so as to prevent the refrigerant from evaporating from freezing frozen water.

Water filter

Check that no impurities prevent the correct passage of water.

Flow switch

- controls the operations
- remove incrustations from the palette

Circulation pumps

Check:

- no leaks
- Bearing status (anomalies are highlighted by abnormal noise and vibration)
- The closing of terminal covers and the correct positioning of the cable glands.

Insulations

Check the condition of the insulations: if necessary, apply glue and renew the seals.

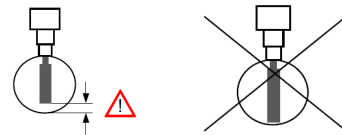

Safety valve

The pressure relief valve must be replaced :

- if it has intervened
- if there is oxidation
- based on the date of manufacture, in compliance with local regulations.

Valve replacing

The 3-piece joint allows the valve replacement.

1. turn off the shut-off valve
2. remove the safety valve
DO NOT WARM THE PIECE
3. remove the valve from the joint
4. assemble the new valve to the joint
clean the parts to be assembled and apply white paste
5. install the new valve
6. turn on the shut-off valve

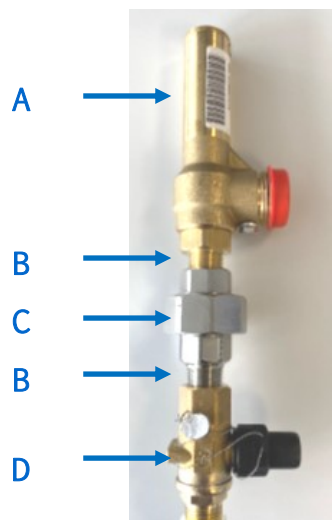

- A safety valve
- B white paste
- C joint 3 pieces
- D shut-off valve

2

3

4

5

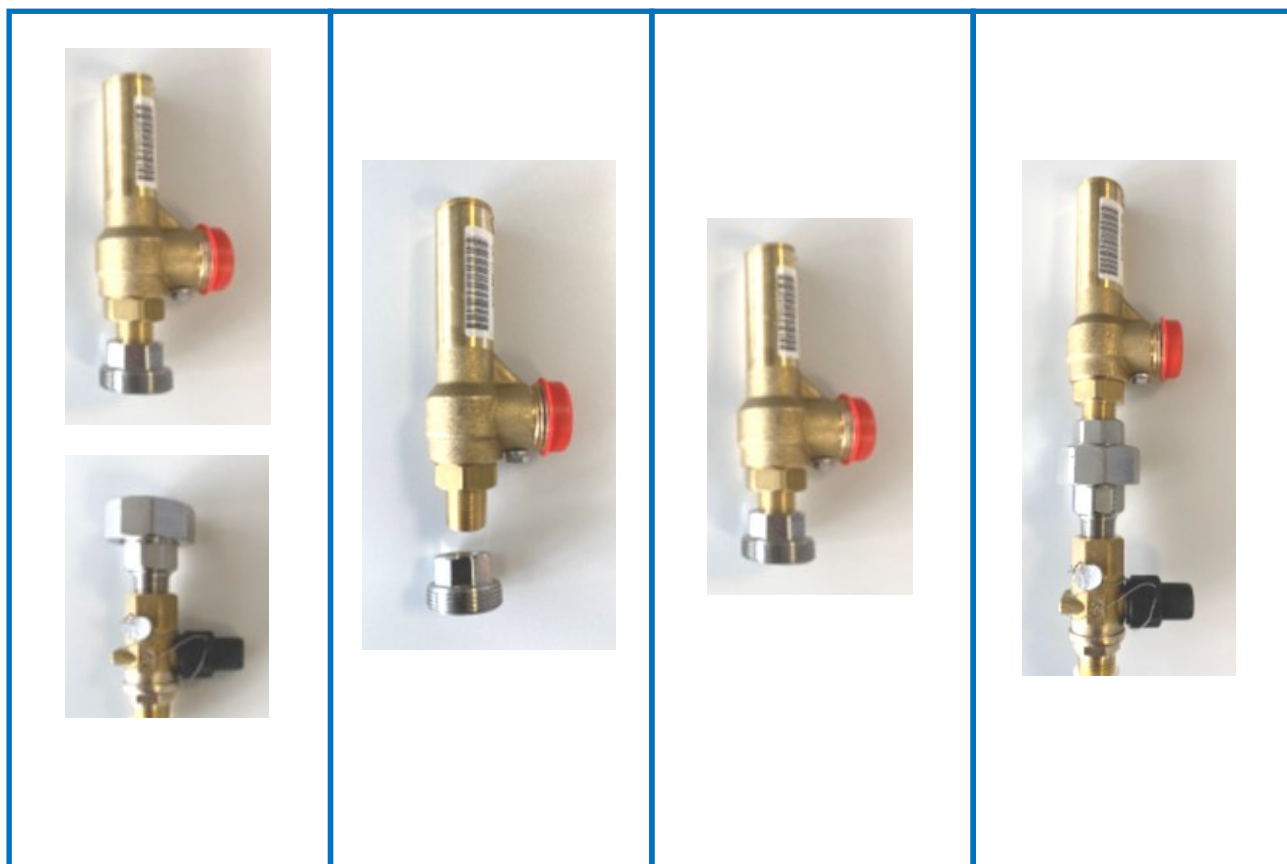

Screw compressors - Periodical checks

Operating hours	100	1000	5000	10000	15000	20000	25000	30000
Vibrations / Noise	C	C	C	C	C	C	C	C
Oil level	C	C	C	C	C	C	C	C/R
Oil filter	C		C		C		C	C/R
Filter the suction			C		C		C	C
Electric insulation		C	C	C	C	C	C	C
Bearings								C/R
check valve		C	C	C	C	C	C	C

C = CHECK

R = replace

To carry out maintenance on the compressor and isolate it from the pressurised circuit, close all shut-off valves (1-4).

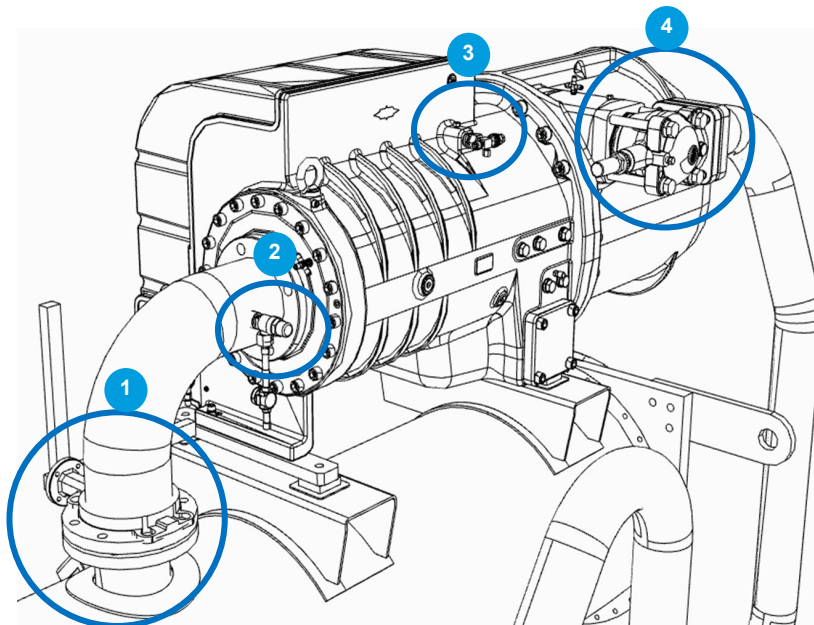

Oil replacement

If the oil needs changing, empty the separator as well.

Use tap 5.

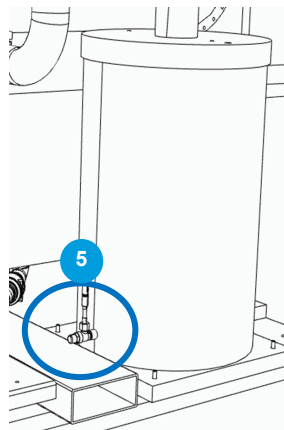

Refrigerant leak detector

Option

For specific information refer to the component manufacturer's manual.

Maintenance

The inspection must be carried out by qualified service personnel.

- Check the correct operation of the LEDs.
- Check the correct functioning of the buzzer and relay.
- Check the signal transmission to the central BMS / controller, if connected.
- Calibrate the sensor or contact the Manufacturer to exchange the sensor with a factory calibrated sensor.

The sensors have an average life of 2 to 5 years, depending on the type, after which they must be replaced.

⇒ *Sensors must be checked after exposure to significant gas concentrations, which can reduce sensor life and / or reduce sensitivity.*

10 ANTIVIBRATION MOUNTS

W1 Wn : see dimensional drawings IOM manual
vedere disegni dimensionali sul manuale

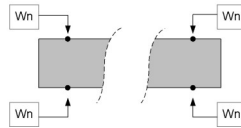

Kit code	W1	W2	W3	W4
PEF100002	70ShA	70ShA	70ShA	60ShA
PEF100003	70ShA	60ShA	70ShA	45ShA
PEF100004	70ShA	60ShA	60ShA	45 ShA
PEF100008	70ShA	60ShA	70ShA	60ShA
PEF100009	80ShA	80ShA	70ShA	70ShA
PEF100010	80ShA	80ShA	60ShA	60ShA
PEF100011	70ShA	70ShA	60ShA	60ShA

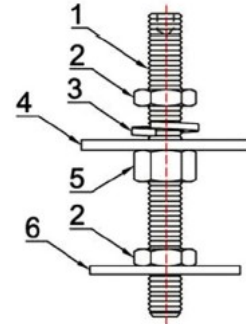
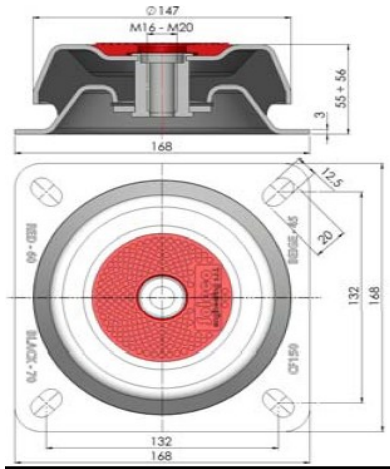

A

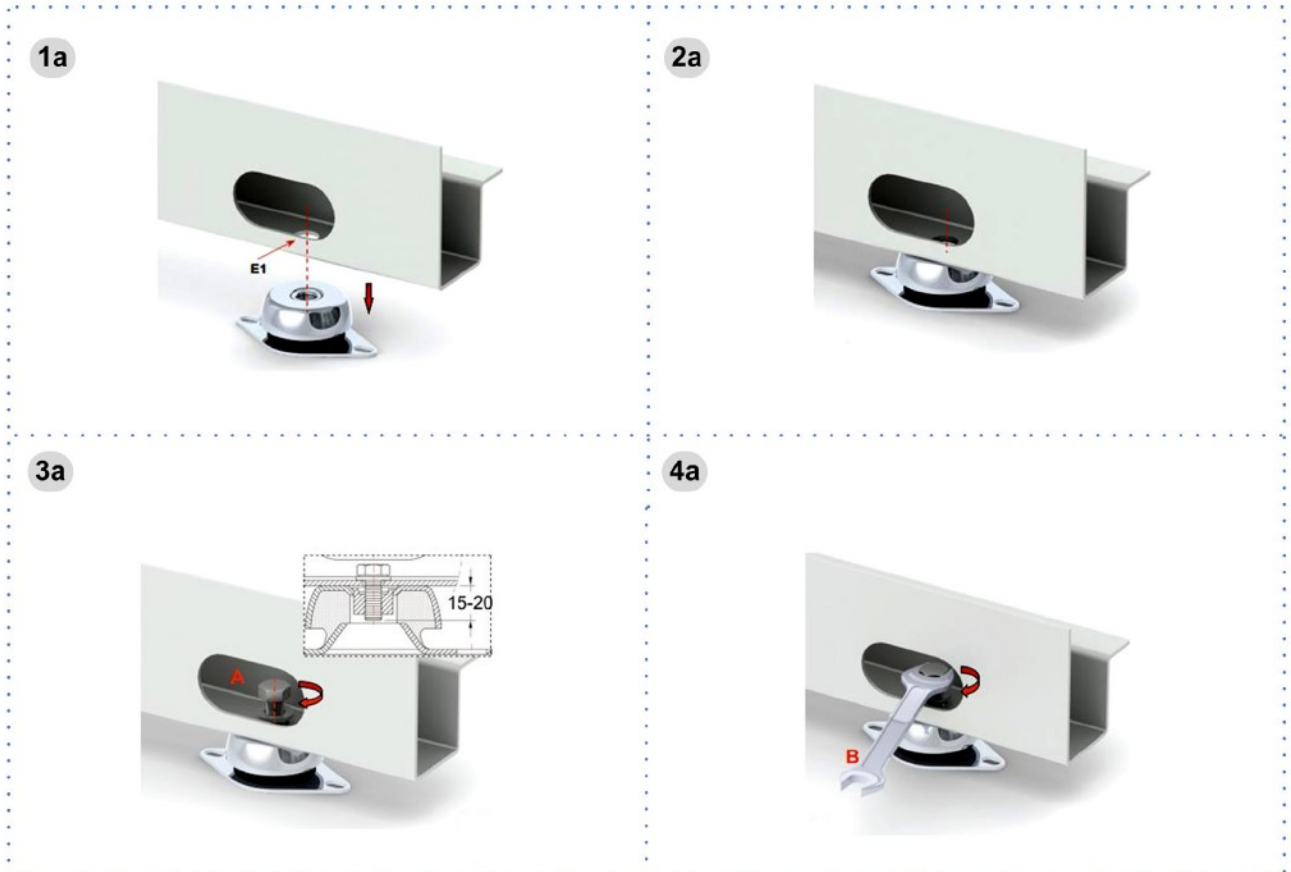
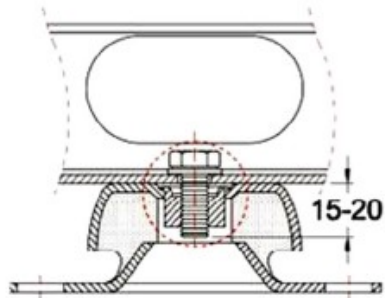

B

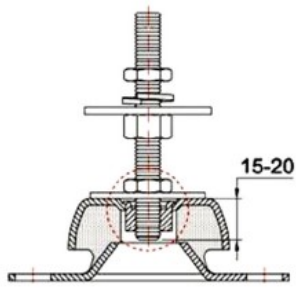

1b



2b



3b

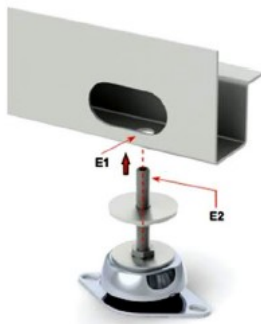

4b

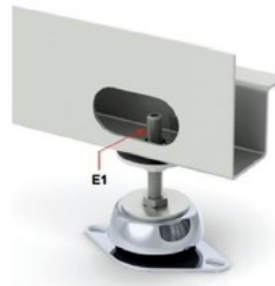

5b

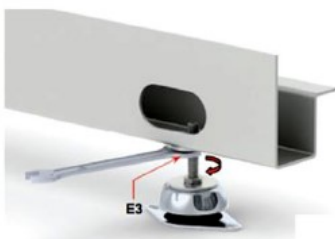

6b



11 DECOMMISSIONING

Disconnection

WARNING

⇒ Before performing any operation, read the warnings found in the Maintenance chapter.

Avoid leak or spills into the environment.

Before disconnecting the unit, the following must be recovered, if present:

- refrigerant gas
- Anti-freeze solutions in the hydraulic circuit

Awaiting decommissioning and disposal, the unit can also be stored outdoors, as bad weather and rapid changes in temperature do not harm the environment provided that the electric, cooling and hydraulic circuits of the unit are intact and closed.

WEEE INFORMATION

The manufacturer is registered on the EEE National Register, in compliance with implementation of Directive 2012/19/EU and relevant national regulations on waste electrical and electronic equipment.

This Directive requires electrical and electronic equipment to be disposed of properly.

Equipment bearing the crossed-out wheelie bin mark must be disposed of separately at the end of its life cycle to prevent damage to human health and to the environment.

Electrical and electronic equipment must be disposed of together with all of its parts.

To dispose of “household” electrical and electronic equipment, the manufacturer recommends you contact an authorised dealer or an authorised ecological area.

“Professional” electrical and electronic equipment must be disposed of by authorised personnel through established waste disposal authorities around the country.

In this regard, here is the definition of household WEEE and professional WEEE:

WEEE from private households: WEEE originating from private households and WEEE which comes from commercial, industrial, institutional and other sources which, because of its nature and quantity, is similar to that from private households. Subject to the nature and quantity, where the waste from EEE was likely to have been by both a private household and users of other than private households, it will be classed as private household WEEE;

Professional WEEE: all WEEE which comes from users other than private households.

This equipment may contain:

refrigerant gas, the entire contents of which must be recovered in suitable containers by specialised personnel with the necessary qualifications;

- lubrication oil contained in compressors and in the cooling circuit to be collected;
- mixtures with antifreeze in the water circuit, the contents of which are to be collected;
- mechanical and electrical parts to be separated and disposed of as authorised.

When machine components to be replaced for maintenance purposes are removed or when the entire unit reaches the end of its life and needs to be removed from the installation, waste should be separated by its nature and disposed of by authorised personnel at existing collection centres.



12 RESIDUAL RISKS

General

In this section the most common situations are indicated, as these cannot be controlled by the manufacturer and could be a source of risk situations for people or things.

Danger zone

This is an area in which only an authorised operator may work.

The danger zone is the area inside the unit which is accessible only with the deliberate removal of protections or parts thereof.

Handling

The handling operations, if implemented without all of the protection necessary and without due caution, may cause the drop or the tipping of the unit with the consequent damage, even serious, to persons, things or the unit itself.

Handle the unit following the instructions provided in the present manual re-garding the packaging and in compliance with the local regulations in force.

Should the refrigerant leak please refer to the refrigerant "Safety sheet".

Installation

The incorrect installation of the unit could cause water leaks, condensate accumulation, leaking of the refrigerant, electric shock, poor operation or damage to the unit itself.

Check that the installation has been implemented by qualified technical personnel only and that the instructions contained in the present manual and the local regulations in force have been adhered to.

The installation of the unit in a place where even infrequent leaks of inflammable gas and the accumulation of this gas in the area surrounding the area occur could cause explosions or fires.

Carefully check the positioning of the unit.

The installation of the unit in a place unsuited to support its weight and/or guarantee adequate anchorage may result in consequent damage to things, people or the unit itself.

Carefully check the positioning and the anchoring of the unit.

Easy access to the unit by children, unauthorised persons or animals may be the source of accidents, some serious.

Install the unit in areas which are only accessible to authorised person and/or provide protection against intrusion into the danger zone.

General risks

Smell of burning, smoke or other signals of serious anomalies may indicate a situation which could cause damage to people, things or the unit itself.

Electrically isolate the unit (yellow-red isolator).

Contact the authorised service centre to identify and resolve the problem at the source of the anomaly.

Accidental contact with exchange batteries, compressors, air delivery tubes or other components may cause injuries and/or burns.

Always wear suitable clothing including protective gloves to work inside the danger zone.

Maintenance and repair operations carried out by non-qualified personnel may cause damage to persons, things or the unit itself.

Always contact the qualified assistance centre.

Failing to close the unit panels or failure to check the correct tightening of all of the panelling fixing screws may cause damage to persons, things or the unit itself.

Periodically check that all of the panels are correctly closed and fixed.

If there is a fire the temperature of the refrigerant could reach values that increase the pressure to beyond the safety valve with the consequent possible projection of the refrigerant itself or explosion of the circuit parts that remain isolated by the closure of the tap.

Do not remain in the vicinity of the safety valve and never leave the refrigerating system taps closed.

Electric parts

An incomplete attachment line to the electric network or with incorrectly sized cables and/or unsuitable protective devices can cause electric shocks, intoxication, damage to the unit or fires.

Carry out all of the work on the electric system referring to the electric layout and the present manual ensuring the use of a system thereto dedicated.

An incorrect fixing of the electric components cover may lead to the entry of dust, water etc inside and may consequently electric shocks, damage to the unit or fires.

Always fix the unit cover properly.

When the metallic mass of the unit is under voltage and is not correctly connected to the earthing system it may be as source of electric shock and electrocution.

Always pay particular attention to the implementation of the earthing system connections.

Contact with parts under voltage accessible inside the unit after the removal of the guards can cause electric shocks, burns and electrocution.

Open and padlock the general isolator prior to removing the guards and signal work in progress with the appropriate sign.

Contact with parts that could be under voltage due to the start up of the unit may cause electric shocks, burns and electrocution.

When voltage is necessary for the circuit open the isolator on the attachment line of the unit itself, padlock it and display the appropriate warning sign.

Moving parts

Contact with the transmissions or with the fan aspiration can cause injuries.

Prior to entering the inside of the unit open the isolator situated on the connection line of the unit itself, padlock and display the appropriate warning sign.

Contact with the fans can cause injury.

Prior to removing the protective grill or the fans, open the isolator on the attachment line of the unit itself, padlock it and display the appropriate warning sign.

Refrigerant

The intervention of the safety valve and the consequent expulsion of the gas refrigerant may cause injuries and intoxication.

Always wear suitable clothing including protective gloves and eyeglasses for operations inside the danger zone.

Should the refrigerant leak please refer to the refrigerant "Safety sheet".

Contact between open flames or heat sources with the refrigerant or the heating of the gas circuit under pressure (e.g. during welding operations) may cause explosions or fires.

Do not place any heat source inside the danger zone.

The maintenance or repair interventions which include welding must be carried out with the system off.

Hydraulic parts

Defects in tubing, the attachments or the removal parts may cause a leak or water projection with the consequent damages to people, things or shortcircuit the unit.

General technical data

Performance

SIZE		120.1	160.1	200.1	220.1	240.1	270.1	290.1	250.2	280.2	320.2	360.2	400.2	480.2	540.2
Cooling															
Cooling capacity	(1) kW	340	416	520	611	690	760	831	705	801	900	1066	1281	1386	1521
Compressor power input	(1) kW	63,7	77,5	97,8	115	132	144	160	132	150	171	200	240	263	292
Total power input	(2) kW	64,7	78,5	98,8	116	133	145	161	133	151	172	201	241	264	293
EER	(1) -	5,26	5,29	5,26	5,28	5,18	5,23	5,17	5,29	5,31	5,23	5,29	5,31	5,26	5,19
Water flow rate (evaporator)	(1) l/s	16,3	19,9	24,8	29,2	33,0	36,3	39,7	33,7	38,3	43,0	50,9	61,2	66,2	72,7
Pressure drops (evaporator)	(1) kPa	23,1	19,4	19,9	24,6	44,0	43,1	34,5	46,5	40,7	39,1	50,3	44,2	45,0	53,6
Water flow rate (condenser)	(1) l/s	19,4	23,6	29,5	34,7	39,4	43,3	47,4	40,1	45,5	51,2	60,6	72,7	78,8	86,7
Pressure drops (condenser)	(1) kPa	25,3	25,6	29,7	28,1	38,4	36,6	37,3	40,5	35,6	28,9	40,6	38,4	31,0	29,5
Cooling capacity (EN14511:2018)	(3) kW	340	415	520	610	690	760	830	705	800	900	1065	1280	1385	1520
Total power input (EN 14511:2018)	(3) kW	66,3	80,1	101	118	138	150	165	138	155	177	208	249	270	300
EER (EN 14511:2018)	(3) -	5,13	5,18	5,13	5,15	5,01	5,06	5,02	5,11	5,15	5,10	5,12	5,14	5,12	5,07
SEER	(4) -	8,41	8,46	8,53	8,57	8,55	8,60	8,57	8,59	8,38	8,47	8,56	8,38	8,51	8,58
SEPR	(5) -	8,45	8,32	8,24	8,55	8,29	8,76	8,31	8,54	8,57	8,22	8,88	8,74	8,77	8,84
Cooling capacity (AHRI 550/590)	(6) kW	342	413	517	607	687	756	826	701	797	896	1060	1274	1379	1513
Total power input (AHRI 550/590)	(6) kW	67,0	80,2	101	118	138	150	165	137	154	177	208	249	268	300
COP _R	(6) -	5,10	5,15	5,11	5,13	4,99	5,04	5,00	5,13	5,17	5,07	5,09	5,12	5,15	5,04
IPLV	(6) -	7,94	7,74	7,78	7,82	7,83	7,52	7,73	7,62	7,82	7,77	7,68	7,62	7,64	7,74
Heating															
Heating capacity	(7) kW	392	490	595	698	796	884	977	783	882	991	1167	1467	1595	1764
Compressor power input	(7) kW	85,3	105	128	149	176	194	216	173	190	210	253	326	347	393
Total power input	(2) kW	86,3	106	129	150	177	195	217	174	191	211	254	327	348	394
COP	(7) -	4,54	4,61	4,62	4,65	4,51	4,53	4,50	4,50	4,61	4,71	4,59	4,49	4,58	4,48
Water flow rate (condenser)	(7) l/s	19,0	23,9	28,7	34,0	38,4	42,7	47,4	38,0	43,0	48,3	56,4	70,8	77,9	85,1
Pressure drops (condenser)	(7) kPa	24,3	26,2	28,0	27,0	36,7	35,7	37,3	36,8	32,3	25,6	35,1	36,4	30,2	28,4
Water flow rate (evaporator)	(7) l/s	24,3	30,6	37,1	43,6	49,3	54,9	60,5	48,5	55,0	62,2	72,7	90,8	99,3	109
Pressure drops (evaporatore)	(7) kPa	51,4	45,6	44,3	62,8	91,0	90,5	84,2	89,6	78,2	78,3	98,0	92,6	96,2	115
Heating capacity (EN 14511:2018)	(8) kW	398	500	602	713	804	894	993	797	901	1011	1181	1483	1631	1781
Total power input (EN 14511:2018)	(8) kW	90,3	111	134	158	186	206	229	185	203	223	269	344	370	411
COP (EN 14511:2018)	(8) -	4,41	4,49	4,50	4,51	4,32	4,35	4,33	4,32	4,44	4,54	4,39	4,31	4,41	4,33
SCOP - Average climate - W55	(4) -	4,97	5,23	5,02	5,18	5,07	5,18	5,15	5,01	5,02	5,05	5,13	5,09	5,01	5,21

The Product is compliant with the Erp (Energy Related Products) European Directive. It includes the Commission delegated Regulation (EU) No 2016/2281, also known as Ecodesign LOT21

1. Data referred to the following conditions: Evaporator water temperature = 12/7 °C. Condenser water temperature = 30/35°C. Evaporator fouling factor = $0,44 \times 10^{(-4)}$ m² K/W
2. The Total Power Input value does not take into account the part related to the pumps and required to overcome the pressure drops for the circulation of the solution inside the exchangers.
3. Data compliant to Standard EN 14511:2018 referred to the following conditions: Evaporator water temperature = 12/7 °C. Condenser water temperature = 30/35°C
4. Data compliant to Standard EN14825:2018
5. Data compliant to Standard EU 2016/2281
6. Data compliant to Standard AHRI 550/590 referred to the following conditions: Evaporator water temperature 12,22°C / 6,7°C. Water flow-rate 0,043 l/s per kW. Condenser water temperature 29,44 °C / 34,61°C. Evaporator fouling factor = $0,18 \times 10^{(-4)}$ m² K/W
7. Data referred to the following conditions: Condenser water temperature = 40/45°C. Evaporator water temperature = 12/7°C. Evaporator fouling factor = $0,18 \times 10^{(-4)}$ m² K/W
8. Data compliant to Standard EN 14511:2018 referred to the following conditions: Condenser water temperature = 40/45°C. Evaporator water temperature = 12/7°C.

Construction

SIZE		120.1	160.1	200.1	220.1	240.1	270.1	290.1	250.2	280.2	320.2	360.2	400.2	480.2	540.2	
Compressor																
Compressor type	(1)	ISW														
Refrigerant		R-513A														
N° compressor	Nr	1							2							
Nominal capacity (C1)	HP	125	160	200	240	240	290	290	125	125	160	160	200	240	240	
Nominal capacity (C2)	HP	-	-	-	-	-	-	-	125	160	160	200	240	240	290	
Std capacity steps	(2)	STEPLESS														
Oil charge (C1)	l	18	18	35	35	35	35	35	18	18	18	18	35	35	35	
Oil charge (C2)	l	-	-	-	-	-	-	-	18	18	18	35	35	35	35	
Refrigerant charge (C1)	(3) kg	110	110	130	130	160	160	170	125	125	135	135	150	150	155	
Refrigerant charge (C2)	(3) kg	-	-	-	-	-	-	-	115	115	125	125	140	140	145	
Refrigerant circuits	Nr	1							2							
Internal exchanger / Evaporator																
Type of exchanger	(4)	S&T SPRAY														
N° of exchanger	Nr	1														
Water content	l	106	124	141	152	187	203	146	187	213	229	236	322	339	339	
Minimum system water content	(5) l	2600	2600	5600	5600	5700	5800	5900	5200	5300	5400	7900	10800	10800	10800	
External exchanger/ Condenser																
Type of exchanger	(4)	S&T														
N° of exchanger	Nr	1														
Water content	l	78	91	111	130	187	209	224	185	221	353	353	423	489	539	
Minimum system water content	(5) l	2500	2500	5400	5500	5600	5700	5800	4800	5200	5300	7600	10400	10700	10700	
Connections																
Evaporator water connections		-	5"	5"	5"	5"	5"	5"	6	5"	5"	6"	6"	8"	8"	8"
Condenser water connections		-	5"	5"	6"	6"	6"	6"	6"	6"	6"	6"	6"	8"	8"	8"
Power supply																
Standard power supply	V	400/3~/50														

1. ISW = Screw compressor with integrated inverter
2. The unit is able to modulate STEPLESS continuously. The following data refers to a continuous operation of the unit.
3. Indicative values for standard units with possible variation +/- 10%. Actual data are shown on the unit's matricular label.
4. S&T = Shell and tube exchanger
5. The calculated water volume to the system does not consider the volume of water contained in the internal exchanger.

Sound levels

ST configuration

SIZE	Sound power level								Sound pressure level	Sound power level
	Octave band (Hz)									
	63	125	250	500	1000	2000	4000	8000	DB(A)	DB(A)
120.1	73	72	72	83	93	89	80	66	75	94
160.1	81	80	77	86	91	91	82	67	77	96
200.1	83	74	84	87	91	88	86	75	78	97
220.1	87	87	79	89	91	88	84	74	78	97
240.1	71	63	76	89	98	89	75	62	78	97
270.1	77	69	79	89	98	90	76	62	79	98
290.1	79	71	80	92	97	91	77	63	79	98
250.2	85	78	85	91	97	94	89	78	81	100
280.2	89	92	82	87	97	91	90	76	82	101
320.2	83	79	83	91	99	90	82	67	82	101
360.2	77	70	82	96	98	93	82	70	83	102
400.2	92	95	85	88	96	92	91	79	83	102
480.2	90	93	86	95	98	98	93	81	83	102
540.2	69	68	85	99	99	96	85	74	84	103

Sound levels refer to full load units, in test nominal conditions. The sound pressure level refers to 1 m. from the standard unit outer surface operating in open field. Measurements are carried out according to the UNI EN ISO 9614-2 standard, in compliance with the EUROVENT 8/1 certification.

Data referred to the following conditions: Evaporator water temperature= 12/7°C; Condenser water temperature = 30/35°C.

EN configuration

SIZE	Sound power level								Sound pressure level	Sound power level
	Octave band (Hz)									
	63	125	250	500	1000	2000	4000	8000	DB(A)	DB(A)
120.1	71	70	70	81	91	87	78	64	72	91
160.1	79	78	75	84	89	89	80	65	74	93
200.1	81	72	82	85	89	86	84	73	75	94
220.1	85	85	77	87	89	86	82	72	75	94
240.1	69	61	74	87	96	87	73	60	75	94
270.1	75	67	77	87	96	88	74	60	76	95
290.1	77	69	78	90	95	89	75	61	76	95
250.2	83	76	83	89	95	92	87	76	78	97
280.2	87	90	80	85	95	89	88	74	79	98
320.2	81	77	81	89	97	88	80	65	79	98
360.2	75	68	80	94	96	91	80	68	80	99
400.2	90	93	83	86	94	90	89	77	80	99
480.2	88	91	84	93	96	96	91	79	80	99
540.2	67	66	83	97	97	94	83	72	81	100

Sound levels refer to full load units, in test nominal conditions. The sound pressure level refers to 1 m. from the standard unit outer surface operating in open field. Measurements are carried out according to the UNI EN ISO 9614-2 standard, in compliance with the EUROVENT 8/1 certification.

Data referred to the following conditions: Evaporator water temperature= 12/7°C; Condenser water temperature = 30/35°C.

Operating range

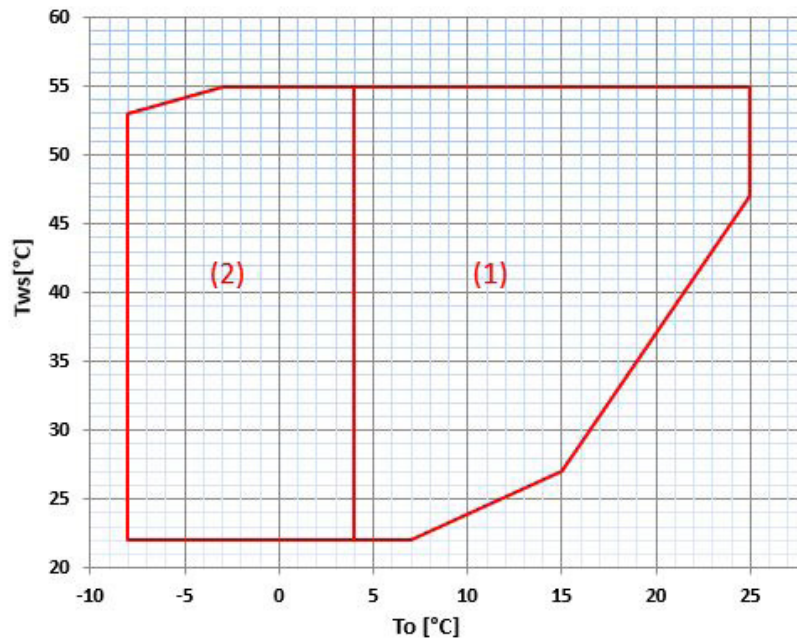

To = Evaporator outlet water temperature
Tws = Condenser outlet water temperature

1. Standard unit operating range
2. Unit operating range in 'Brine - Low water temperature' configuration

Exchanger operating range

INTERNAL EXCHANGER (EVAPORATOR)

	DPR	DPW
PED (CE)	2400	1000

DPr = Maximum operating pressure on refrigerant side in kPa
DPw = Maximum operating pressure on water side in kPa

Overload and control device calibrations

		OPEN	CLOSE	VALUE
High pressure switch	[kPa]	1900	1400	-
Antifreeze protection	[°C]	3	5,5	-
High pressure safety valve	[kPa]	-	-	2400
Low pressure safety valve	[kPa]	-	-	1500
Max no. of compressor starts per hour	[n°]	-	-	6
Discharge safety thermostat	[°C]	-	-	120

High water temperature version - HWT

Performance

SIZE		120.1	160.1	200.1	220.1	240.1	270.1	290.1	250.2	280.2	320.2	360.2	400.2	480.2	540.2	
Cooling																
Cooling capacity	(1)	kW	344	418	517	608	688	761	828	705	796	901	1062	1281	1393	1527
Compressor power input	(1)	kW	64,6	80,7	98,3	116	136	156	175	136	156	177	208	259	277	317
Total power input	(2)	kW	65,6	81,7	99,3	117	137	157	176	137	157	178	209	260	278	318
EER	(1)	-	5,25	5,12	5,20	5,21	5,01	4,85	4,70	5,16	5,06	5,06	5,08	4,92	5,00	4,80
Water flow rate (evaporator)	(1)	l/s	16,4	20,0	24,7	29,1	32,9	36,3	39,6	33,7	38,0	43,0	50,7	61,2	66,6	72,9
Pressure drops (evaporator)	(1)	kPa	23,8	19,6	19,7	24,5	43,9	43,3	34,5	46,5	40,5	39,3	50,2	44,2	45,7	54,2
Water flow rate (condenser)	(1)	l/s	19,6	23,9	29,4	34,6	39,4	43,8	48,0	40,2	45,5	51,6	60,7	73,7	79,9	88,2
Pressure drops (condenser)	(1)	kPa	25,9	26,2	29,6	28,1	38,7	37,6	38,4	40,9	35,9	29,4	41,1	39,6	32,0	30,7
Cooling capacity (EN14511:2018)	(3)	kW	344	418	516	608	687	760	828	704	795	900	1061	1280	1393	1526
Total power input (EN 14511:2018)	(3)	kW	67,3	83,6	102	119	142	161	181	141	162	183	216	268	285	326
EER (EN 14511:2018)	(3)	-	5,11	5,00	5,08	5,10	4,85	4,71	4,58	4,99	4,92	4,93	4,92	4,78	4,88	4,69
SEER	(4)	-	7,91	7,59	7,82	7,88	7,84	7,78	7,74	8,05	7,79	7,73	7,77	7,76	7,79	7,79
SEPR	(5)	-	8,23	8,11	8,03	8,34	8,08	8,54	8,10	8,33	8,35	8,01	8,65	8,52	8,55	8,62
Cooling capacity (AHRI 550/590)	(6)	kW	342	416	514	605	684	756	824	701	792	896	1056	1274	1386	1519
Total power input (AHRI 550/590)	(6)	kW	67,9	84,3	103	120	143	163	182	143	163	184	218	270	288	328
COP _R	(6)	-	5,04	4,93	5,01	5,03	4,79	4,64	4,52	4,92	4,85	4,86	4,85	4,71	4,81	4,62
IPLV	(6)	-	7,44	7,29	7,29	7,25	7,27	7,12	7,25	7,17	7,25	7,14	7,13	7,00	7,02	7,18
Heating																
Heating capacity	(7)	kW	405	507	616	722	824	915	1011	810	913	1026	1208	1518	1651	1825
Compressor power input	(7)	kW	83,9	104	125	148	174	192	215	171	188	209	252	323	343	386
Total power input	(2)	kW	84,9	105	126	149	175	193	216	172	189	210	253	324	344	387
COP	(7)	-	4,77	4,85	4,90	4,86	4,71	4,73	4,69	4,71	4,83	4,90	4,77	4,69	4,80	4,72
Water flow rate (condenser)	(7)	l/s	19,4	24,2	29,4	34,5	39,4	43,7	48,3	38,7	43,6	49,0	57,7	72,5	78,9	87,2
Pressure drops (condenser)	(7)	kPa	43,8	47,1	51,9	48,7	63,0	61,2	65,0	62,4	65,0	70,0	72,0	80,0	82,0	88,0
Water flow rate (evaporator)	(7)	l/s	25,5	32,1	39,0	45,7	51,7	57,5	63,4	50,8	57,7	65,0	76,0	95,1	104	115
Pressure drops (evaporatore)	(7)	kPa	56,8	50,2	48,9	70,3	99,4	98,8	93,2	97,5	85,4	85,5	107	101	105	126
Heating capacity (EN 14511:2018)	(8)	kW	411	514	624	732	835	927	1024	820	924	1037	1221	1534	1667	1844
Total power input (EN 14511:2018)	(8)	kW	88,9	110	132	156	183	202	226	180	198	219	264	338	360	405
COP (EN 14511:2018)	(8)	-	4,63	4,70	4,75	4,71	4,56	4,58	4,54	4,56	4,68	4,74	4,62	4,54	4,64	4,56
SCOP - Average climate - W55	(4)	-	4,64	4,88	4,69	4,84	4,73	4,84	4,81	4,72	4,74	4,76	4,83	4,80	4,73	4,91

The Product is compliant with the Erp (Energy Related Products) European Directive. It includes the Commission delegated Regulation (EU) No 2016/2281, also known as Ecodesign LOT21

1. Data referred to the following conditions: Evaporator water temperature = 12/7 °C. Condenser water temperature = 30/35°C. Evaporator fouling factor = $0.44 \times 10^{(-4)}$ m² K/W
2. The Total Power Input value does not take into account the part related to the pumps and required to overcome the pressure drops for the circulation of the solution inside the exchangers.
3. Data compliant to Standard EN 14511:2018 referred to the following conditions: Evaporator water temperature = 12/7 °C. Condenser water temperature = 30/35°C
4. Data compliant to Standard EN14825:2018
5. Data compliant to Standard EU 2016/2281
6. Data compliant to Standard AHRI 550/590 referred to the following conditions: Evaporator water temperature 12,22°C / 6,7°C. Water flow-rate 0,043 l/s per kW. Condenser water temperature 29,44 °C / 34,61°C. Evaporator fouling factor = $0.18 \times 10^{(-4)}$ m² K/W
7. Data referred to the following conditions: Condenser water temperature = 40/45°C. Evaporator water temperature = 12/7°C. Evaporator fouling factor = $0.18 \times 10^{(-4)}$ m² K/W
8. Data compliant to Standard EN 14511:2018 referred to the following conditions: Condenser water temperature = 40/45°C. Evaporator water temperature = 12/7°C.

High water temperature version - HWT

Construction

SIZE		120.1	160.1	200.1	220.1	240.1	270.1	290.1	250.2	280.2	320.2	360.2	400.2	480.2	540.2	
Compressor																
Compressor type	(1)	ISW														
Refrigerant		R-513A														
N° compressor	Nr	1							2							
Nominal capacity (C1)	HP	125	160	200	240	240	290	290	125	125	160	160	200	240	240	
Nominal capacity (C2)	HP	-	-	-	-	-	-	-	125	160	160	200	240	240	290	
Std capacity steps	(2)	STEPLESS														
Oil charge (C1)	l	18	18	35	35	35	35	35	18	18	18	18	35	35	35	
Oil charge (C2)	l	-	-	-	-	-	-	-	18	18	18	35	35	35	35	
Refrigerant charge (C1)	(3) kg	110	110	130	130	160	160	170	125	125	135	135	150	150	155	
Refrigerant charge (C2)	(3) kg	-	-	-	-	-	-	-	115	115	125	125	140	140	145	
Refrigerant circuits	Nr	1							2							
Internal exchanger / Evaporator																
Type of exchanger	(4)	S&T SPRAY														
N° of exchanger	Nr	1														
Water content	l	106	124	141	152	187	203	146	187	213	229	236	322	339	339	
Minimum system water content	(5) l	2600	2600	5600	5600	5700	5800	5900	5200	5300	5400	7900	10800	10800	10800	
External exchanger/ Condenser																
Type of exchanger	(4)	S&T														
N° of exchanger	Nr	1														
Water content	l	78	91	111	130	187	209	224	185	221	353	353	423	489	539	
Minimum system water content	(5) l	2500	2500	5400	5500	5600	5700	5800	4800	5200	5300	7600	10400	10700	10700	
Connections																
Evaporator water connections	-	5"	5"	5"	5"	5"	5"	6	5"	5"	6"	6"	8"	8"	8"	
Condenser water connections	-	5"	5"	6"	6"	6"	6"	6"	6"	6"	6"	6"	8"	8"	8"	
Power supply																
Standard power supply	V	400/3~/50														

1. ISW = Screw compressor with integrated inverter
2. The unit is able to modulate STEPLESS continuously. The following data refers to a continuous operation of the unit.
3. Indicative values for standard units with possible variation +/- 10%. Actual data are shown on the unit's matricular label.
4. S&T = Shell and tube exchanger
5. The calculated water volume to the system does not consider the volume of water contained in the internal exchanger.

High water temperature version - HWT

Sound levels

ST configuration

SIZE	Sound power level								Sound pressure level	Sound power level
	Octave band (Hz)									
	63	125	250	500	1000	2000	4000	8000	DB(A)	DB(A)
120.1	73	72	72	83	93	89	80	66	75	94
160.1	81	80	77	86	91	91	82	67	77	96
200.1	83	74	84	87	91	88	86	75	78	97
220.1	87	87	79	89	91	88	84	74	78	97
240.1	71	63	76	89	98	89	75	62	78	97
270.1	77	69	79	89	98	90	76	62	79	98
290.1	79	71	80	92	97	91	77	63	79	98
250.2	85	78	85	91	97	94	89	78	81	100
280.2	89	92	82	87	97	91	90	76	82	101
320.2	83	79	83	91	99	90	82	67	82	101
360.2	77	70	82	96	98	93	82	70	83	102
400.2	92	95	85	88	96	92	91	79	83	102
480.2	90	93	86	95	98	98	93	81	83	102
540.2	69	68	85	99	99	96	85	74	84	103

Sound levels refer to full load units, in test nominal conditions. The sound pressure level refers to 1 m. from the standard unit outer surface operating in open field. Measurements are carried out according to the UNI EN ISO 9614-2 standard, in compliance with the EUROVENT 8/1 certification.

Data referred to the following conditions: Evaporator water temperature= 12/7°C; Condenser water temperature = 30/35°C.

EN configuration

SIZE	Sound power level								Sound pressure level	Sound power level
	Octave band (Hz)									
	63	125	250	500	1000	2000	4000	8000	DB(A)	DB(A)
120.1	71	70	70	81	91	87	78	64	72	91
160.1	79	78	75	84	89	89	80	65	74	93
200.1	81	72	82	85	89	86	84	73	75	94
220.1	85	85	77	87	89	86	82	72	75	94
240.1	69	61	74	87	96	87	73	60	75	94
270.1	75	67	77	87	96	88	74	60	76	95
290.1	77	69	78	90	95	89	75	61	76	95
250.2	83	76	83	89	95	92	87	76	78	97
280.2	87	90	80	85	95	89	88	74	79	98
320.2	81	77	81	89	97	88	80	65	79	98
360.2	75	68	80	94	96	91	80	68	80	99
400.2	90	93	83	86	94	90	89	77	80	99
480.2	88	91	84	93	96	96	91	79	80	99
540.2	67	66	83	97	97	94	83	72	81	100

Sound levels refer to full load units, in test nominal conditions. The sound pressure level refers to 1 m. from the standard unit outer surface operating in open field. Measurements are carried out according to the UNI EN ISO 9614-2 standard, in compliance with the EUROVENT 8/1 certification.

Data referred to the following conditions: Evaporator water temperature= 12/7°C; Condenser water temperature = 30/35°C.

High water temperature version - HWT

Operating range

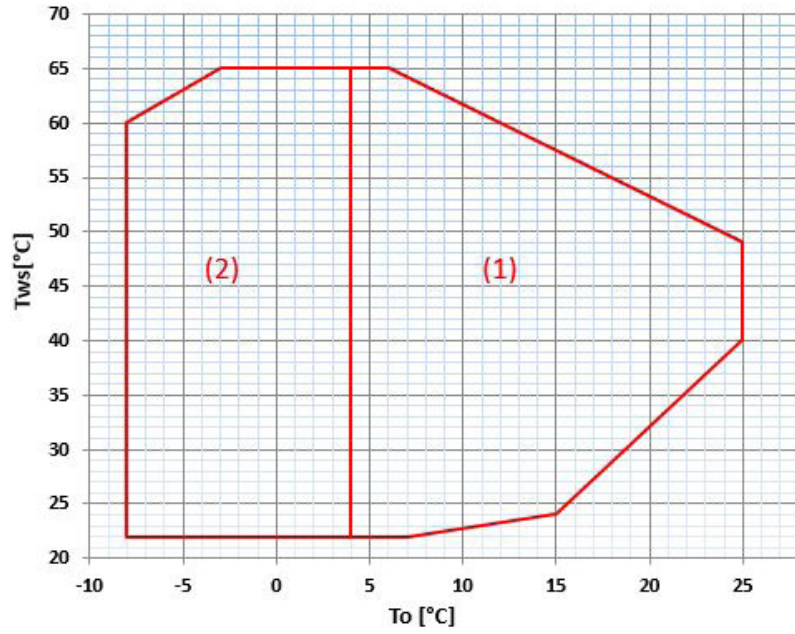

To = Evaporator outlet water temperature
Tws = Condenser outlet water temperature

1. Standard unit operating range
2. Unit operating range in 'Brine - Low water temperature' configuration

Dimensional drawings

SIZE 120.1 - 160.1

DAAF10002_00
DATA/DATE 10/11/2020

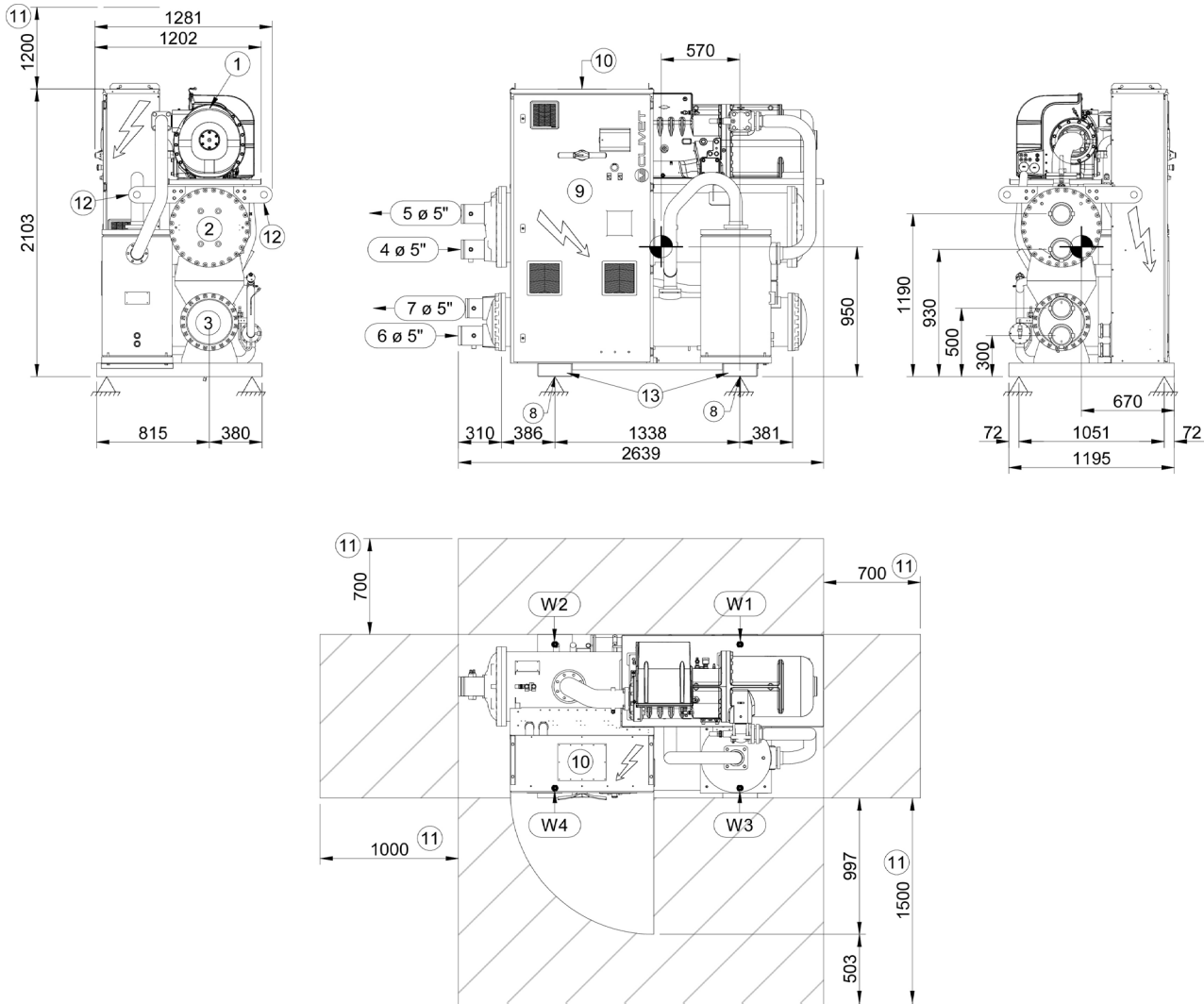

- | | |
|---|--|
| 1. Compressor | 8. Antivibration holes $\varnothing 25$ mm |
| 2. Internal exchanger (evaporator) | 9. Electrical panel |
| 3. External exchanger (condenser) | 10. Power input |
| 4. Internal exchanger water inlet (OD) 139.7 | 11. Maintenance spaces |
| 5. Internal exchanger water outlet (OD) 139.7 | 12. Lifting bracket (removed) |
| 6. External exchanger water inlet (OD) 139.7 | 13. Lift with forklift |
| 7. External exchanger water outlet (OD) 139.7 | |

SIZE		120.1	160.1
Length	mm	2639	2639
Depth	mm	1195	1195
Height	mm	2103	2103
W1 Supporting point	kg	1047	1092
W2 Supporting point	kg	805	841
W3 Supporting point	kg	788	790
W4 Supporting point	kg	601	606
Operating weight	kg	3241	3328
Shipping weight	kg	3057	3113

The presence of optional accessories may result in a substantial variation of the weights shown in the table. Fan diffusers are separately supplied.

SIZE 200.1 - 220.1

DAAF10005_00
DATA/DATE 11/11/2020

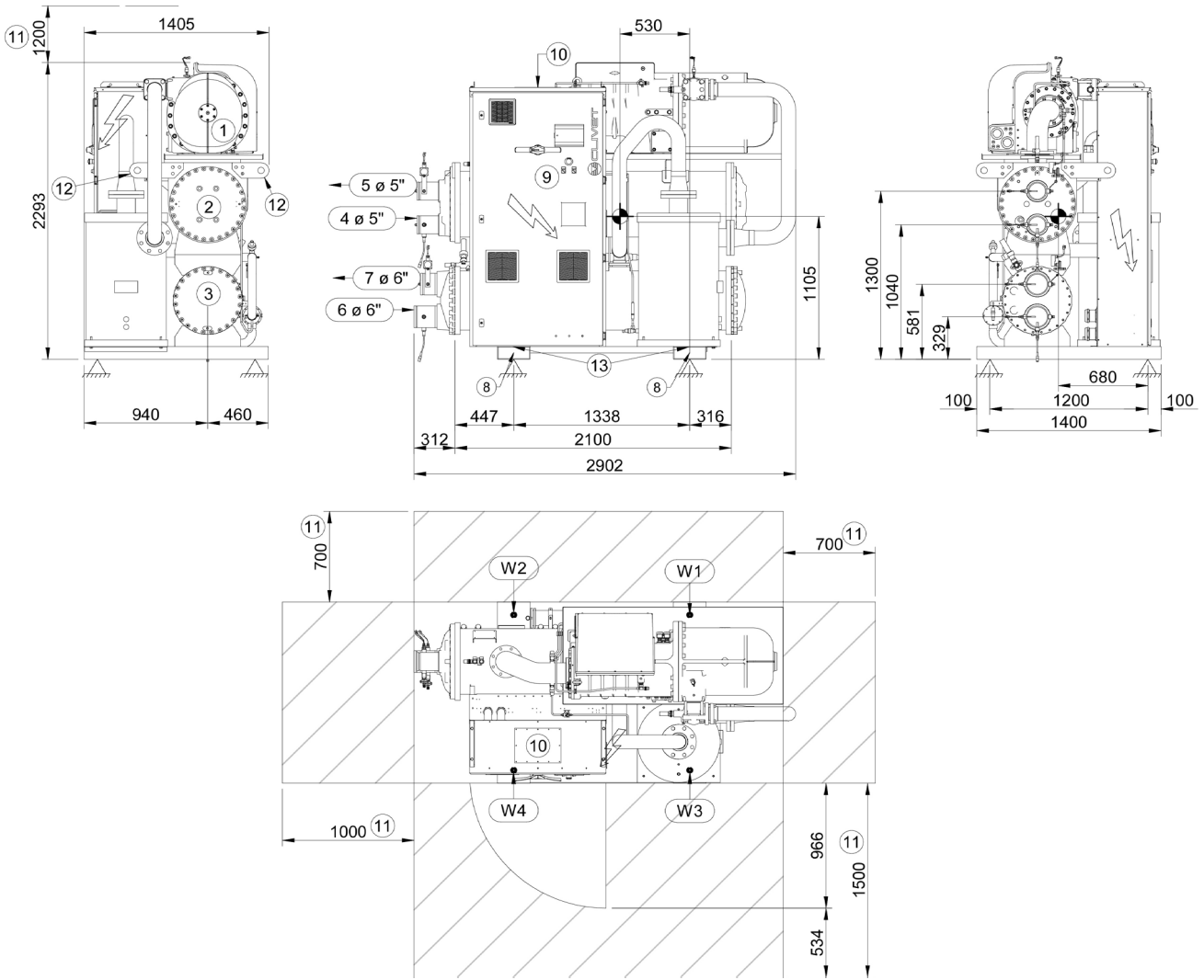

- | | |
|---|--|
| 1. Compressor | 8. Antivibration holes $\varnothing 25$ mm |
| 2. Internal exchanger (evaporator) | 9. Electrical panel |
| 3. External exchanger (condenser) | 10. Power input |
| 4. Internal exchanger water inlet (OD) 139.7 | 11. Maintenance spaces |
| 5. Internal exchanger water outlet (OD) 139.7 | 12. Lifting bracket (removed) |
| 6. External exchanger water inlet (OD) 168.3 | 13. Lift with forklift |
| 7. External exchanger water outlet (OD) 168.3 | |

SIZE		200.1	220.1
Length	mm	2902	2902
Depth	mm	1400	1400
Height	mm	2293	2293
W1 Supporting point	kg	1556	1554
W2 Supporting point	kg	870	870
W3 Supporting point	kg	1157	1152
W4 Supporting point	kg	634	631
Operating weight	kg	4217	4207
Shipping weight	kg	3965	3955

The presence of optional accessories may result in a substantial variation of the weights shown in the table. Fan diffusers are separately supplied.

SIZE 240.1 - 270.1

DAAF10004_00
DATA/DATE 11/11/2020

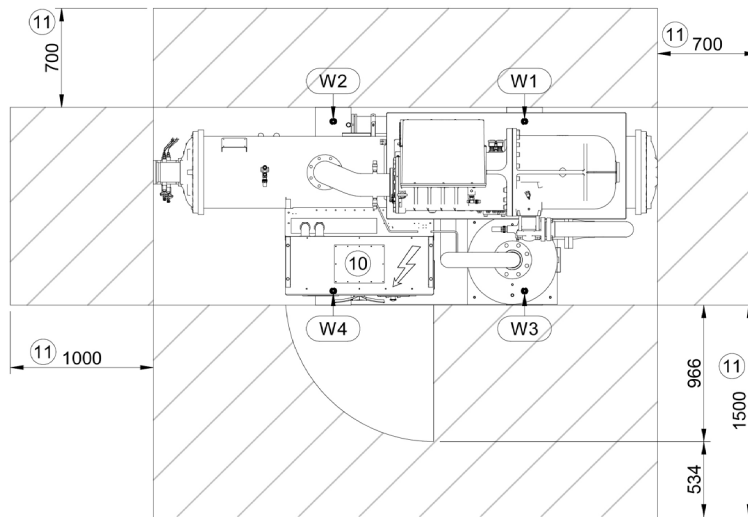
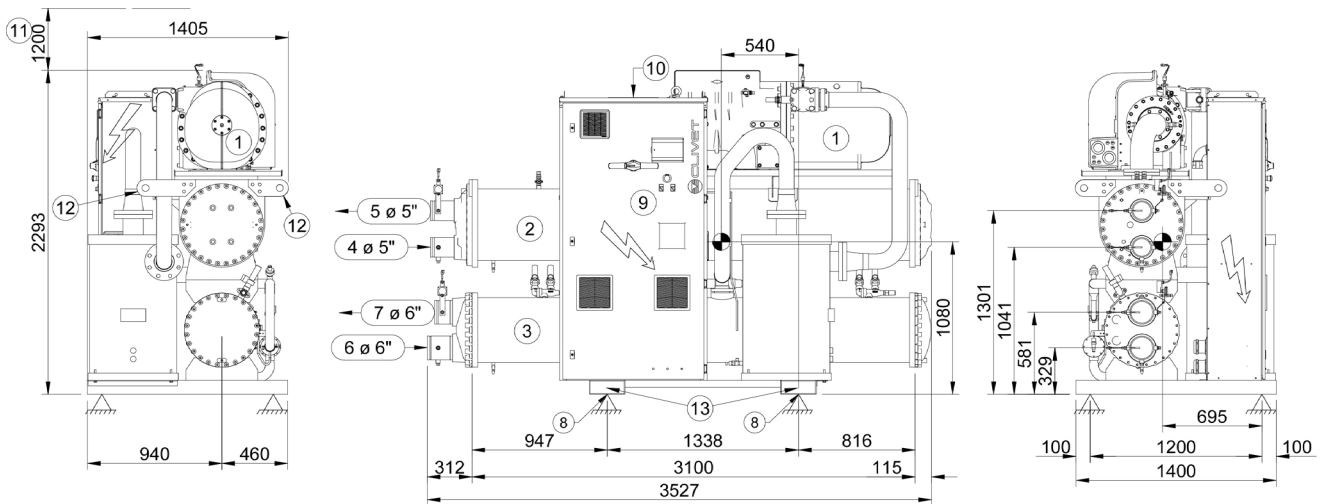

- | | |
|---|--|
| 1. Compressor | 8. Antivibration holes $\varnothing 25$ mm |
| 2. Internal exchanger (evaporator) | 9. Electrical panel |
| 3. External exchanger (condenser) | 10. Power input |
| 4. Internal exchanger water inlet (OD) 139.7 | 11. Maintenance spaces |
| 5. Internal exchanger water outlet (OD) 139.7 | 12. Lifting bracket (removed) |
| 6. External exchanger water inlet (OD) 168.3 | 13. Lift with forklift |
| 7. External exchanger water outlet (OD) 168.3 | |

SIZE		240.1	270.1
Length	mm	3527	3527
Depth	mm	1400	1400
Height	mm	2293	2293
W1 Supporting point	kg	1785	1797
W2 Supporting point	kg	1082	1096
W3 Supporting point	kg	1244	1247
W4 Supporting point	kg	737	744
Operating weight	kg	4849	4884
Shipping weight	kg	4422	4472

The presence of optional accessories may result in a substantial variation of the weights shown in the table. Fan diffusers are separately supplied.

SIZE 290.1

DAAF10009_00
DATA/DATE 25/11/2020

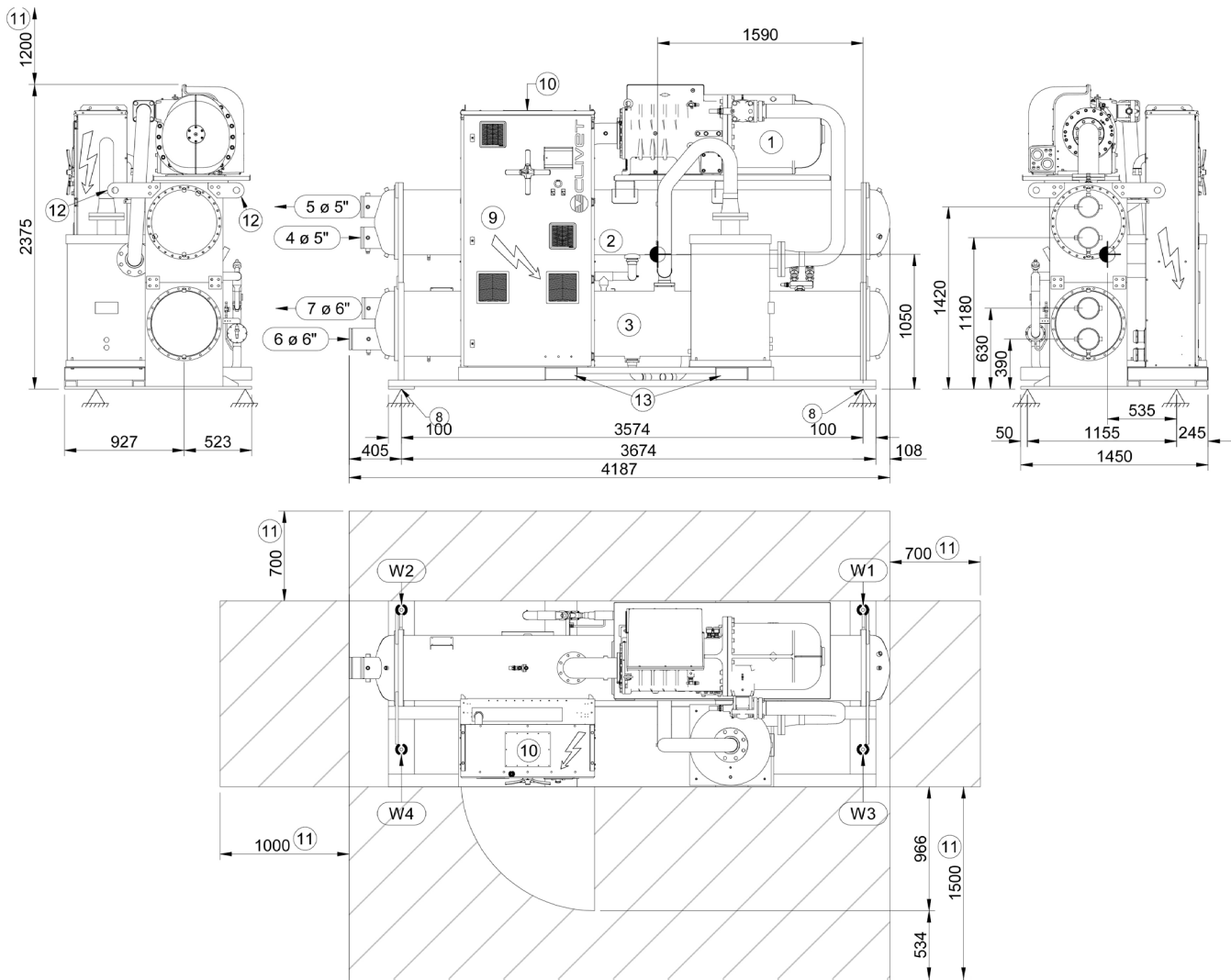

- | | |
|---|-------------------------------|
| 1. Compressor | 8. Antivibration holes ø25 mm |
| 2. Internal exchanger (evaporator) | 9. Electrical panel |
| 3. External exchanger (condenser) | 10. Power input |
| 4. Internal exchanger water inlet (OD)168.3 | 11. Maintenance spaces |
| 5. Internal exchanger water outlet (OD) 168.3 | 12. Lifting bracket (removed) |
| 6. External exchanger water inlet (OD) 168.3 | 13. Lift with forklift |
| 7. External exchanger water outlet (OD) 168.3 | |

SIZE		290.1
Length	mm	4187
Depth	mm	1450
Height	mm	2375
W1 Supporting point	kg	1547
W2 Supporting point	kg	1263
W3 Supporting point	kg	1218
W4 Supporting point	kg	985
Operating weight	kg	5013
Shipping weight	kg	4643

The presence of optional accessories may result in a substantial variation of the weights shown in the table. Fan diffusers are separately supplied.

SIZE 250.2 - 280.2

DAAF10007_00
DATA/DATE 24/11/2020

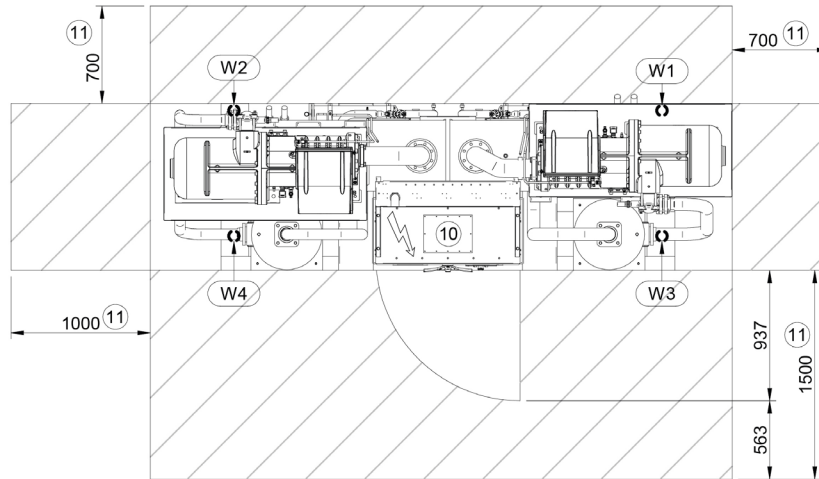
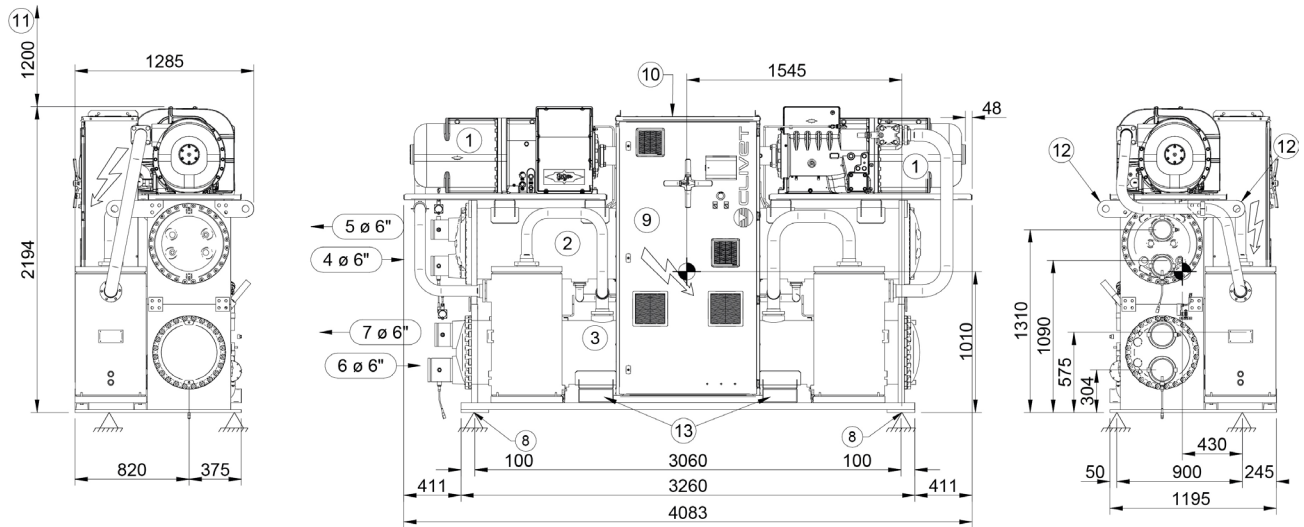

- | | |
|---|--|
| 1. Compressor | 8. Antivibration holes $\varnothing 25$ mm |
| 2. Internal exchanger (evaporator) | 9. Electrical panel |
| 3. External exchanger (condenser) | 10. Power input |
| 4. Internal exchanger water inlet (OD)168.3 | 11. Maintenance spaces |
| 5. Internal exchanger water outlet (OD) 168.3 | 12. Lifting bracket (removed) |
| 6. External exchanger water inlet (OD) 168.3 | 13. Lift with forklift |
| 7. External exchanger water outlet (OD) 168.3 | |

SIZE		250.2	280.2
Length	mm	4083	4083
Depth	mm	1195	1195
Height	mm	2194	2194
W1 Supporting point	kg	1601	1677
W2 Supporting point	kg	1622	1695
W3 Supporting point	kg	1123	1154
W4 Supporting point	kg	1139	1167
Operating weight	kg	5484	5694
Shipping weight	kg	5115	5260

The presence of optional accessories may result in a substantial variation of the weights shown in the table. Fan diffusers are separately supplied.

SIZE 320.2

DAAF10006_00
DATA/DATE 24/11/2020

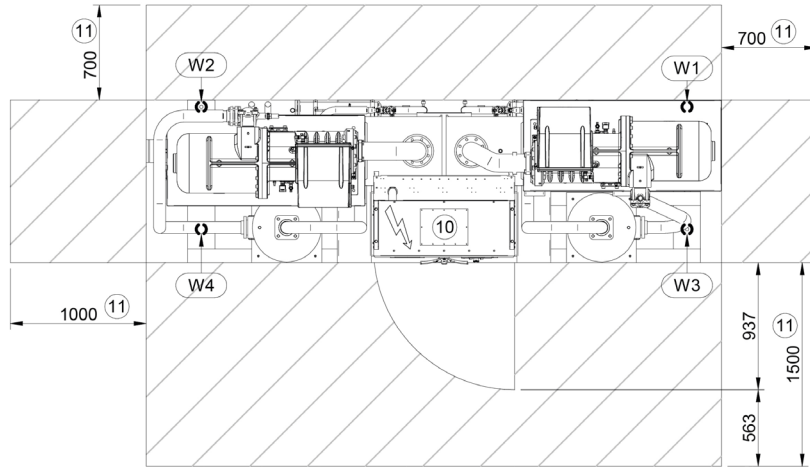
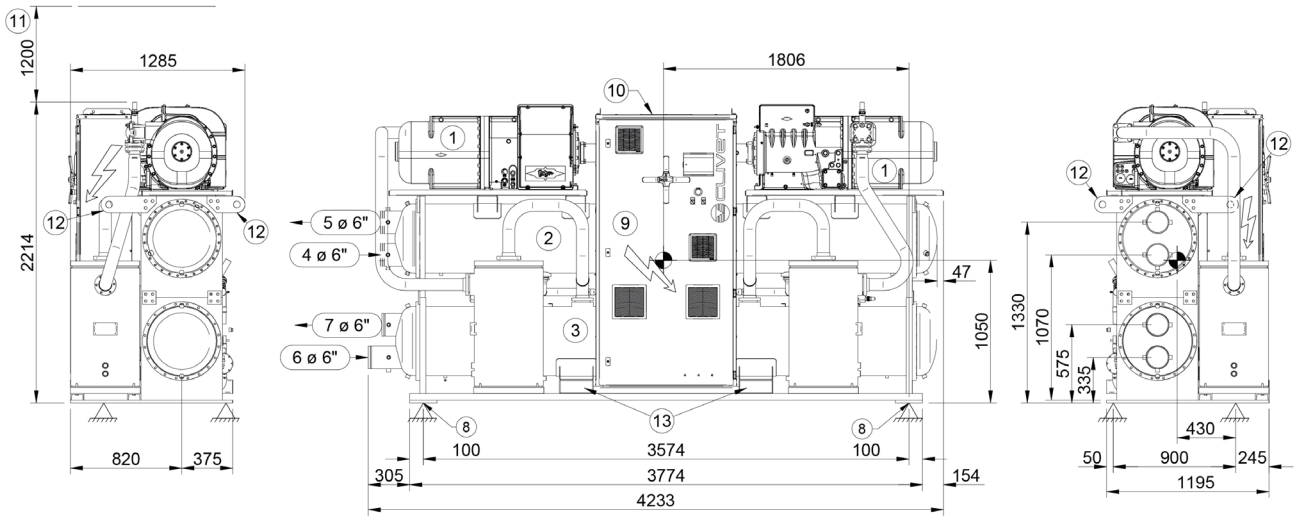

- 1. Compressor
- 2. Internal exchanger (evaporator)
- 3. External exchanger (condenser)
- 4. Internal exchanger water inlet (OD)168.3
- 5. Internal exchanger water outlet (OD) 168.3
- 6. External exchanger water inlet (OD) 168.3
- 7. External exchanger water outlet (OD) 168.3
- 8. Antivibration holes $\varnothing 25$ mm
- 9. Electrical panel
- 10. Power input
- 11. Maintenance spaces
- 12. Lifting bracket (removed)
- 13. Lift with forklift

SIZE		320.2
Length	mm	4233
Depth	mm	1195
Height	mm	2214
W1 Supporting point	kg	1980
W2 Supporting point	kg	2007
W3 Supporting point	kg	1235
W4 Supporting point	kg	1253
Operating weight	kg	6475
Shipping weight	kg	5893

The presence of optional accessories may result in a substantial variation of the weights shown in the table. Fan diffusers are separately supplied.

SIZE 360.2

DAAF10008_00
DATA/DATE 25/11/2020

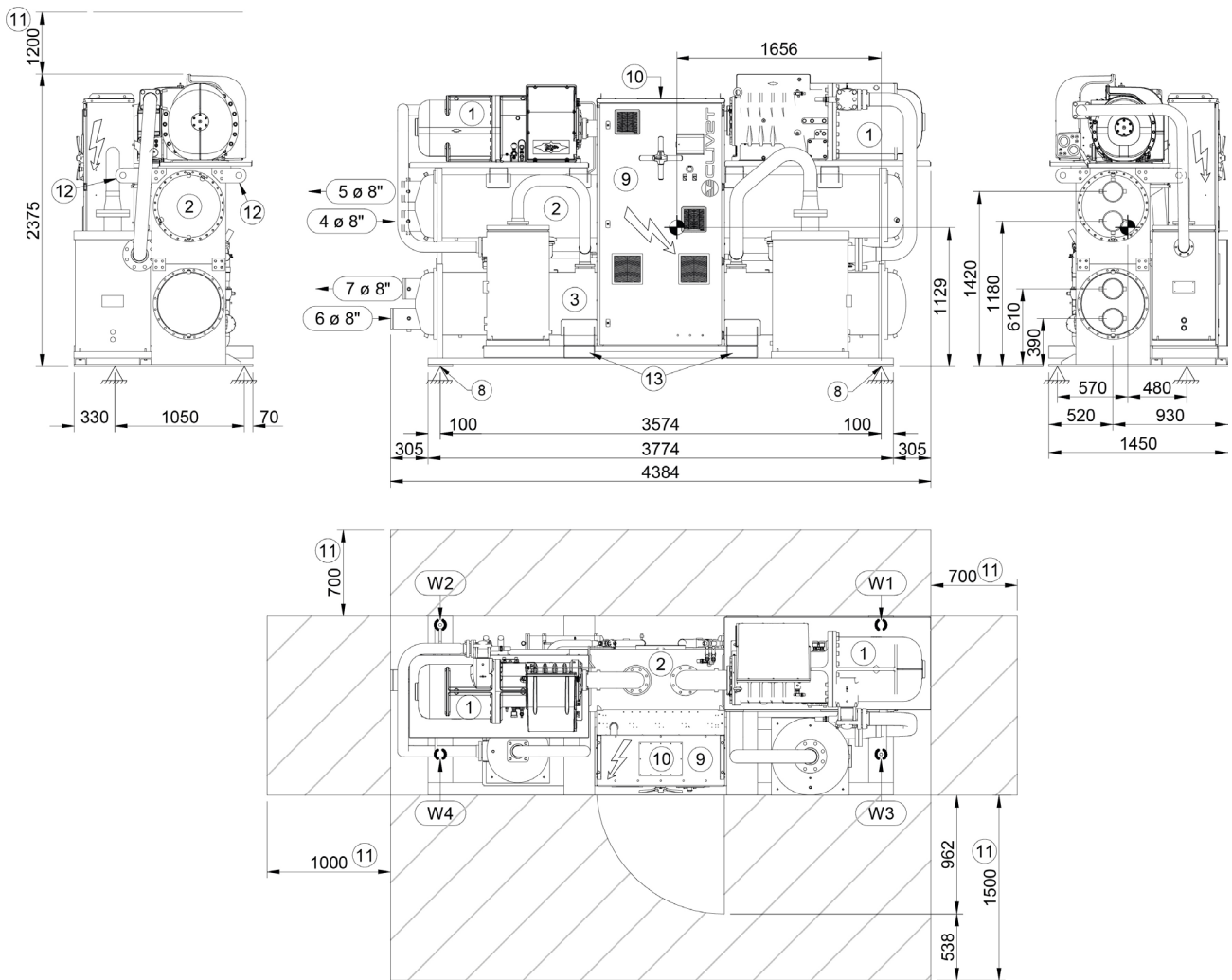

- | | |
|---|--|
| 1. Compressor | 8. Antivibration holes \varnothing 25 mm |
| 2. Internal exchanger (evaporator) | 9. Electrical panel |
| 3. External exchanger (condenser) | 10. Power input |
| 4. Internal exchanger water inlet (OD) 168.3 | 11. Maintenance spaces |
| 5. Internal exchanger water outlet (OD) 168.3 | 12. Lifting bracket (removed) |
| 6. External exchanger water inlet (OD) 168.3 | 13. Lift with forklift |
| 7. External exchanger water outlet (OD) 168.3 | |

SIZE		360.2
Length	mm	4384
Depth	mm	1450
Height	mm	2375
W1 Supporting point	kg	2468
W2 Supporting point	kg	2129
W3 Supporting point	kg	1422
W4 Supporting point	kg	1222
Operating weight	kg	7241
Shipping weight	kg	6652

The presence of optional accessories may result in a substantial variation of the weights shown in the table. Fan diffusers are separately supplied.

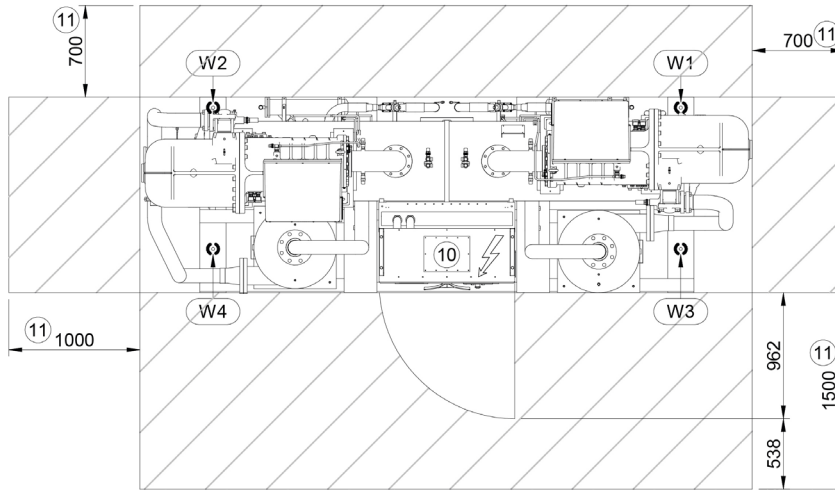
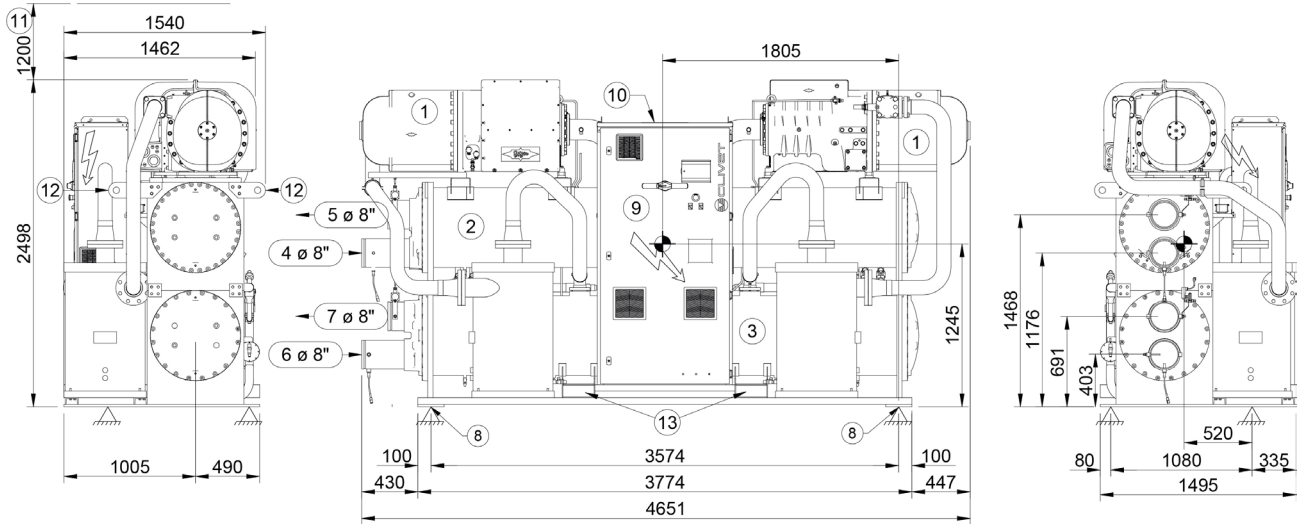

- 1. Compressor
- 2. Internal exchanger (evaporator)
- 3. External exchanger (condenser)
- 4. Internal exchanger water inlet (OD) 219.1
- 5. Internal exchanger water outlet (OD) 219.1
- 6. External exchanger water inlet (OD) 219.1
- 7. External exchanger water outlet (OD) 219.1
- 8. Antivibration holes $\varnothing 25$ mm
- 9. Electrical panel
- 10. Power input
- 11. Maintenance spaces
- 12. Lifting bracket (removed)
- 13. Lift with forklift

SIZE		400.2	480.2	540.2
Length	mm	4651	4651	4651
Depth	mm	1495	1495	1495
Height	mm	2498	2498	2498
W1 Supporting point	kg	2782	2761	2782
W2 Supporting point	kg	2918	2902	2918
W3 Supporting point	kg	1718	1711	1718
W4 Supporting point	kg	1807	1803	1807
Operating weight	kg	9225	9177	9225
Shipping weight	kg	8397	8349	8397

The presence of optional accessories may result in a substantial variation of the weights shown in the table. Fan diffusers are separately supplied.

FOR OVER 30 YEARS, WE HAVE BEEN
OFFERING SOLUTIONS TO ENSURE
SUSTAINABLE COMFORT AND THE WELL-
BEING OF PEOPLE AND THE ENVIRONMENT



sales and assistance

www.clivet.com



MideaGroup
humanizing technology

CLIVET S.p.A.

Via Camp Lonc 25, Z.I. Villapaiera
32032 Feltre (BL) - Italy
Tel. +39 0439 3131 - info@clivet.it

CLIVET GMBH

Hummelsbütteler Steindamm 84,
22851 Norderstedt, Germany
Tel. +49 40 325957-0 - info.de@clivet.com

Clivet Group UK LTD

Units F5 & F6 Railway Triangle,
Portsmouth, Hampshire PO6 1TG
Tel. +44 02392 381235 -
Enquiries@Clivetgroup.co.uk

CLIVET LLC

Office 508-511, Elektrozavodskaya st. 24,
Moscow, Russian Federation, 107023
Tel. +7495 6462009 - info.ru@clivet.com

CLIVET MIDEAST FZCO

Dubai Silicon Oasis (DSO), High Bay Complex,
Office N. 20, PO BOX 342009, Dubai, UAE
Tel. +9714 3208499 - info@clivet.ae

Clivet South East Europe

Jarušćica 9b
10000, Zagreb, Croatia
Tel. +385916065691 - info.see@clivet.com

Clivet Airconditioning Systems Pvt Ltd

Office No.501 & 502,5th Floor, Commercial -I,
Kohinoor City, Old Premier Compound, Off
LBS Marg, Kirool Road, Kurla West, Mumbai
Maharashtra 400070, India
Tel. +91 22 30930200 - sales.india@clivet.com