

# WSAT-YSC4

**80.3 - 240.6**



**Manual  
for installation  
use and maintenance**



---

Dear Customer,

We congratulate you on choosing these product

Clivet has been working for years to offer systems able to assure the maximum comfort for a long time with highly-reliable, efficient, high-quality and safe solutions.

The target of the company is to offer advanced systems, that assure the best comfort and reduce energy consumption as well as the installation and maintenance costs for the entire life-cycle of the system.

With this manual, we want to give you information that are useful for all phases: from reception, installation and use to disposal - so that such an advanced system can provide the best performances during installation and use.

Best regards and have a good read.

CLIVET Spa

The original instructions are written in Italian.

All other languages are translations of the original instructions.

The data contained in this manual is not binding and may be changed by the manufacturer without prior notice. Reproduction, even is part, is FORBIDDEN

© Copyright - CLIVET S.p.A. - Feltre (BL) - Italy

---

# Summary

<b>1.</b>	<b>Safety considerations .....</b>	<b>7</b>
1.1	Safety .....	7
1.2	Manual .....	7
1.3	Risk situations .....	7
1.4	Symbols .....	7
1.5	Intended use .....	7
1.6	Installation .....	7
1.7	Maintenance .....	7
1.8	Modification .....	7
1.9	Breakdown/Malfuction .....	8
1.10	User training .....	8
1.11	Data update .....	8
<b>2.</b>	<b>Indications for the User .....</b>	<b>9</b>
2.1	In case of breakdown or malfunction: .....	9
2.2	The installer must train the user, particularly on: .....	9
2.3	Unit identification .....	9
2.4	Serial number .....	9
2.5	Assistance request .....	9
<b>3.</b>	<b>Information on refrigerant gas .....</b>	<b>10</b>
<b>4.</b>	<b>Before installation .....</b>	<b>11</b>
4.1	Reception .....	11
4.2	Storage .....	11
4.3	Packaging removing .....	11
4.4	Handling .....	11
<b>5.</b>	<b>Selecting the installation site .....</b>	<b>13</b>
5.1	General .....	13
5.2	Functional spaces .....	13
5.3	Positioning .....	13
5.4	Safety valve gas side .....	13
<b>6.</b>	<b>Water connections .....</b>	<b>15</b>
6.1	Hydraulic system .....	15
6.2	Water quality .....	15
6.3	Cleanliness .....	15
6.4	New systems .....	15
6.5	Existing systems .....	15
6.6	Risk of freezing .....	16
6.7	Anti-freeze solution .....	16
6.8	Water filter .....	16
6.9	Water flow-rate .....	16
6.10	Minimum system water content .....	16
6.11	Flow Switch .....	17
6.12	Non-return valve .....	17
6.13	Operation sequence .....	17

6.14	Partial energy recovery .....	19
<b>7.</b>	<b>Electrical connections.....</b>	<b>20</b>
7.1	Electrical data .....	20
7.2	Connections.....	20
7.3	Power supply network requirements .....	20
7.4	Signals / data lines .....	20
7.5	Power line inlet .....	21
7.6	Remote ON-OFF .....	21
7.7	Electrical panel.....	21
7.8	Connections performed by Customer .....	22
7.9	Controller wiring sections.....	23
7.10	Computer connection.....	24
7.11	Remote control.....	25
7.12	Modbus - RS485 .....	26
7.13	LonWorks .....	27
7.14	BACnet IP.....	27
7.15	Ecoshare .....	28
<b>8.</b>	<b>Start-up .....</b>	<b>31</b>
8.1	Start-up sequence .....	32
8.2	Start-up sequence .....	33
8.3	Refrigeration circuit.....	34
8.4	Electric Circuit.....	34
8.5	Water circuit .....	34
8.6	Compressor casing resistances.....	34
8.7	Voltages .....	34
8.8	Options.....	35
8.9	Demand limit.....	36
8.10	Climatic TExt .....	37
8.11	Water reset.....	38
8.12	Reduced load operation .....	39
8.13	Checking the evaporator water flow-rate .....	39
8.14	Start-up report .....	39
8.15	2014/68/UE PED directive.....	39
<b>9.</b>	<b>Control .....</b>	<b>40</b>
9.1	LED .....	40
9.2	Display.....	40
9.3	Buttons .....	40
9.4	Change unit status .....	41
9.5	Change mode .....	41
9.6	Change setpoint .....	41
9.7	Display statuses .....	42
9.8	Scheduler.....	42
9.9	Scheduler enabling .....	42
9.10	Keypad settings.....	42
9.11	Alarms.....	43
9.12	General list of alarms.....	43
<b>10.</b>	<b>SAFETY WARNINGS FOR OPERATIONS ON UNITS CONTAINING R32.....</b>	<b>50</b>

10.1	Area checks .....	50
10.2	Work procedures .....	50
10.3	General work area.....	50
10.4	Check the presence of refrigerant.....	50
10.5	Presence of the fire extinguisher .....	50
10.6	No ignition source .....	50
10.7	Ventilated area .....	50
10.8	Cooling equipment checks .....	50
10.9	Electrical device checks .....	50
10.10	Repairing sealed components .....	51
10.11	Reparation of intrinsically safe components .....	51
10.12	Wires .....	51
10.13	Detection of flammable refrigerants.....	51
10.14	Leak detection methods .....	51
10.15	Removal and evacuation .....	51
10.16	Charging operations .....	52
10.17	Dismantling.....	52
10.18	Labelling.....	52
10.19	Recovery .....	52
10.20	Transport, mark and storage .....	53
<b>11.</b>	<b>Maintenance.....</b>	<b>54</b>
11.1	Safety .....	54
11.2	General.....	54
11.3	Inspections frequency.....	54
11.4	Unit booklet.....	54
11.5	Standby mode .....	54
11.6	Recommended periodical checks.....	56
11.7	System drain .....	57
11.8	Compressor crankcase heater.....	57
11.9	Water side exchanger.....	57
11.10	Water filter .....	57
11.11	Flow Switch .....	57
11.12	Circulation pumps.....	57
11.13	Insulations.....	57
11.14	Pressure relief valve .....	57
11.15	Structure.....	57
11.16	Air side exchanger.....	57
11.17	Electric fans.....	58
11.18	Refrigerant leak detector.....	58
<b>12.</b>	<b>Anti-vibration mounts .....</b>	<b>59</b>
12.1	Anti-vibration mount support.....	59
12.2	Anti-seismic anti-vibration mounts.....	61
<b>13.</b>	<b>Decommissioning .....</b>	<b>63</b>
13.1	Disconnection.....	63
13.2	WEEE INFORMATION .....	63
<b>14.</b>	<b>Residual risks .....</b>	<b>64</b>
14.1	General.....	64

---

14.2	Danger zone .....	64
14.3	Handling.....	64
14.4	Installation .....	64
14.5	General risks .....	64
14.6	Electric parts .....	64
14.7	Moving parts .....	65
14.8	Refrigerant.....	65
14.9	Hydraulic parts .....	65
<b>15.</b>	<b>Technical information .....</b>	<b>66</b>

# 1. Safety considerations

## 1.1 Safety

Operate in compliance with safety regulations in force.

To carry out the operations use protection devices:

- gloves, goggles, hard hat, ear protection, protective knee pads.

All operations must be carried out by personnel trained on possible risks of a general nature, electrical and deriving from operating with equipment under pressure.

Only qualified personnel can operate on the unit, as required by the regulation in force.

## 1.2 Manual

The manual provides correct unit installation, use and maintenance.

It is advisable to read it carefully so you will save time during operations.

Follow the written indications so you will not cause damages to things and injuries people.

## 1.3 Risk situations

The unit has been designed and created to prevent injuries to people.

During designing it is not possible to plane and operate on all risk situation.

 **Read carefully “Residual risk” section where all situation which may cause damages to things and injuries to people are reported.**

Installation, starting, maintenance and repair required specific knowledge; if they are carried out by inexperienced personnel, they may cause damages to things and injuries people.

## 1.4 Symbols

The symbols in the following chapter can be found in the manual and on the product, and provide quick and clear information for correct and safe use.

### 1.4.1 Safety symbols

#### **Danger**

This symbol indicates warnings, failure to comply may result in serious harm to health and fatal injuries.

#### **Attention**

This symbol indicates warnings, failure to comply

may result in irreparable damage to the product or harm to the environment.

#### **Prohibition**

This symbol indicates operations that must never be carried out.

#### **Note**

This symbol indicates important information.

## 1.5 Intended use

Use the unit only:

- for cooling/heating water or a water and glycol mix
- keep to the limits foreseen in the technical schedule and in this manual

The manufacturer accepts no responsibility if the equipment is used for any purpose other than the intended use.

## 1.6 Installation

#### **Outdoor installation**

The positioning, hydraulic system, refrigerating, electrics and the ducting of the air must be determined by the system designer in accordance with local regulations in force.

Comply with local safety regulations in all operations.

Verify that the electrical line characteristics are in compliance with data quotes on the unit serial number label.

## 1.7 Maintenance

Plan periodic inspection and maintenance in order to avoid or reduce repairing costs.

Turn the unit off before any operation.

## 1.8 Modification

All unit modifications will end the warranty coverage and the manufacturer responsibility.

## 1.9 Breakdown/Malfuction

Disable the unit immediately in case of breakdown or malfunction.

Contact a certified service agent.

Use original spares parts only.

Using the unit in case of breakdown or malfunction:

- voids the warranty
- it may compromise the safety of the unit
- may increase time and repair costs

## 1.10 User training

The installer has to train the user on:

- Start-up/shutdown
- Set points change
- Standby mode
- Maintenance
- What to do / what not to do in case of breakdown

## 1.11 Data update

Continuous product improvements may imply manual data changes.

Visit manufacturer web site for updated data.

## 2. Indications for the User

Keep this manual with the wiring diagram in an accessible place for the operator.

Note the unit data label so you can provide them to the assistance centre in case of intervention (see “Unit identification” section).

Provide a unit notebook that allows any interventions carried out on the unit to be noted and tracked making it easier to suitably note the various interventions and aids the search for any breakdowns.

### 2.1 In case of breakdown or malfunction:

Immediately deactivate the unit

Contact a service centre authorized by the manufacturer

### 2.2 The installer must train the user, particularly on:

- Start-up/shutdown
- Set points change
- Standby mode
- Maintenance
- What to do / what not to do in case of breakdown

### 2.3 Unit identification

The serial number label is positioned on the unit and allows to identify all the unit features.

The type plate shows the indications foreseen by the standards, in particular:

- unit type
- serial number (12 characters)
- year of manufacture
- wiring diagram number
- electrical data
- type of refrigerant
- refrigerant charge
- manufacturer logo and address

The matriculation plate must never be removed.

### 2.4 Serial number

It identifies uniquely each unit.

It must be cited when ordering spare parts.

### 2.5 Assistance request

Note data from the serial number label and write them in the chart on side, so you will find them easily when needed.

### 3. Information on refrigerant gas

 This product contains fluorinated greenhouse gases covered by the Kyoto protocol.

 Do not discharge gas into air.

 Refrigerant type: R32

Characteristics of R32 refrigerant:

- minimum environmental impact thanks to the low Global Warming Potential GWP
- low flammability, class A2L according to ISO 817
- low combustion speed
- low toxicity

#### Refrigerant characteristics

Safety class (ISO 817)	A2L	
GWP	675	
LFL Low flammability limit	0.307	kg/m <sup>3</sup> @ 60°C
BV Burning velocity	6,7	cm/s
Boiling point	-52	°C
GWP	675	100 yr ITH
GWP	677	ARS 100 yr ITH
Self-ignition temperature	648	°C

#### NOTE

 The refrigerant quantity is indicated on the unit plate

## 4. Before installation

### 4.1 Reception

You have to check before accepting the delivery:

- That the unit hasn't been damaged during transport
- That the materials delivered correspond with that indicated on the transport document comparing the data with the identification label positioned on the packaging.

In case of damage or anomaly:

- Write down on the transport document the damage you found and quote this sentence: "Conditional acceptance clear evidence of deficiencies/damages during transport"
- Contact by fax and registered mail with advice of receipt to supplier and the carrier.

**!** Any disputes must be made within 8 days from the date of the delivery. Complaints after this period are invalid.

### 4.2 Storage

Observe external packaging instructions.

In particular:

- minimum ambient temperature -15°C (possible components damages)
- maximum ambient temperature +49C (possible safety valve opening)
- maximum relative humidity 95% (possible damages to electrical components)

**!** The unit may not be tilted more than 15° during transport.

### 4.3 Packaging removing

**!** Be careful not to damage the unit.

Recycle and dispose of the packaging material in conformity with local regulations.

### 4.4 Handling

**!** Check that all handling equipment complies with local safety regulations (cran, forklifts, ropes, hooks, etc.).

**!** Provide personnel with personal protective equipment appropriate for the situation, such as hard hat, gloves, safety shoes, etc.

**!** Observe all safety procedures in order

to guarantee the safety of the personnel present and the of material.

**!** Check the weight of the unit and the lifting capacity of the handling equipment.

**!** Identify critical points during handling (disconnected routes, flights, steps, doors).

**!** Suitably protect the unit to prevent damage.

Lifting with balance

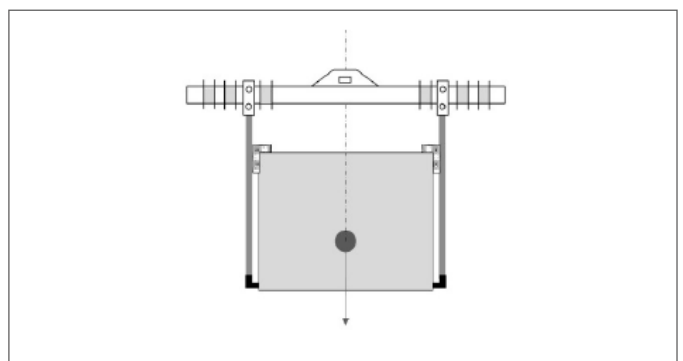

Lifting with spacer bar

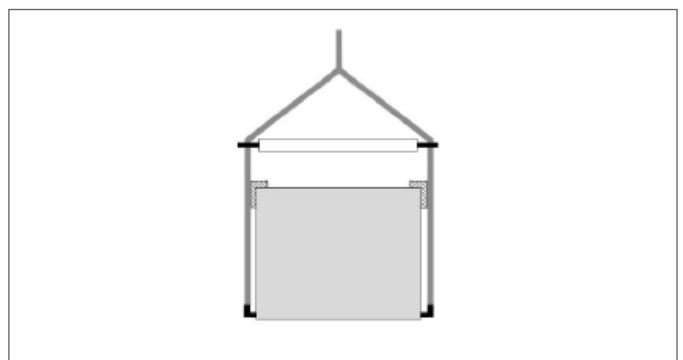

Align the barycenter to the lifting point.

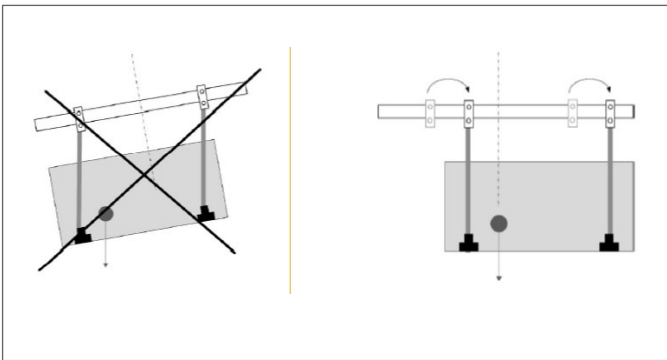
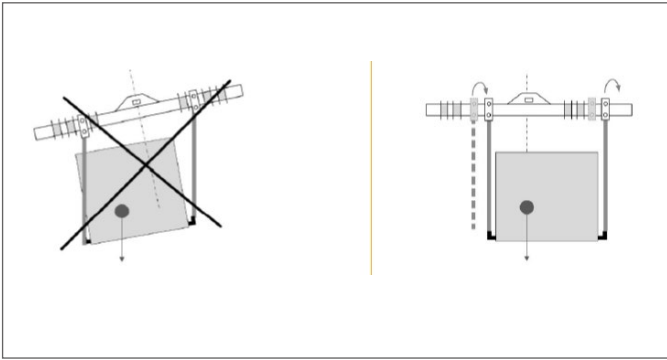

Gradually bring the lifting belts under tension, making sure they are positioned correctly.

Before starting the handling, make sure that the unit is stable.

## 5. Selecting the installation site

### 5.1 General

Installation must be in accordance with local regulations. If they do not exist, follow EN378 .

During positioning consider these elements:

- customer approval
- weight of the unit and capacity of the bearing points
- safe accessible position
- functional spaces
- spaces for the air intake/exhaust
- Electrical connections
- max. distance allowed by the electrical connections
- Water connections

### 5.2 Functional spaces

Functional spaces are designed to:

- guarantee good unit operation
- carry out maintenance operations
- protect authorized operators and exposed people

 Respect all functional spaces indicated in the DIMENSIONS section.

 Do not smoke or use open flames within this area

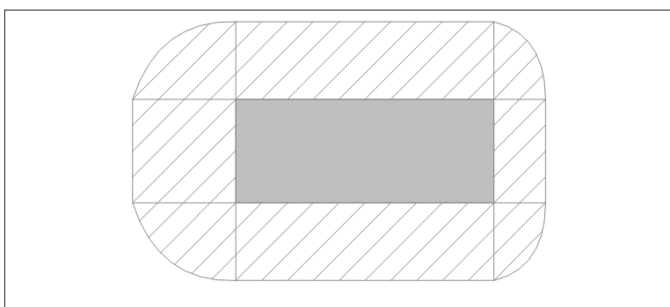

### 5.3 Positioning

Units are designed to be installed:

- in fixed positions
- level

 Put the unit in a position where any leaking gas cannot enter buildings or stagnate in closed areas. In the latter case, observe the rules for machinery rooms (ventilation, leak detection, etc.).

Choose the installation place according to the following criteria:

- install the unit raised from the ground
- bearing points aligned and leveled
- discharged condensation water must not cause harm/danger to people and property
- the accumulation of snow must not cause clogging of the coils
- avoid installations in places subject to flooding

Limit vibration transmission:

- use anti-vibration devices or neoprene strips on the unit support points
- install flexible joints on the hydraulic and aeraulic connections

Protect the unit with suitable fence in order to avoid access to unauthorised personnel (children, vandals, etc.)

A correct circulation of the air is mandatory to guarantee the good unit operating.

 The unit must be level.

 Do not go up to the surface

 Do not place heavy loads.

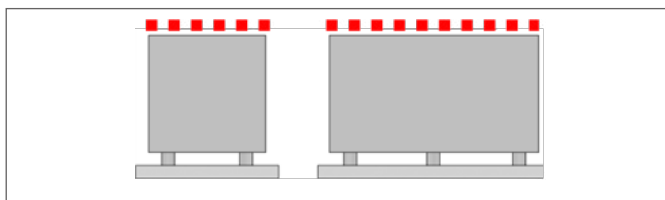

Avoid therefore:

- obstacles to the airflow
- difficulty of exchange
- leaves or other foreign bodies that can obstruct the air coil
- winds that hinder or favour the airflow
- heat or pollution sources close to the unit (chimneys, extractors etc.)
- stratification (cold air that stagnates at the bottom)
- recirculation (expelled air that is sucked in again)
- incorrect positioning, close to very high walls, attics or in angles that could give rise to stratification or recirculation phenomenons

Ignoring the previous indications could:

- reduce energy efficiency
- alarm lockout due to HIGH PRESSURE (in summer) or LOW PRESSURE (in winter)

### 5.4 Safety valve gas side

The installer is responsible for evaluating the opportunity

of installing drain tubes, in conformity with the local regulations in force (EN 378).

If ducted, the valves must be sized according to EN13136.

**⚠** The air flow must not be obstructed

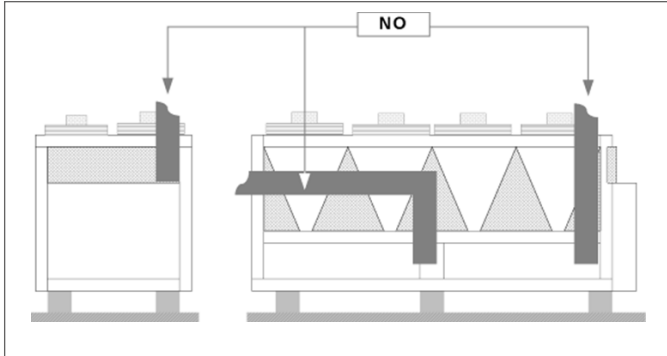

## 6. Water connections

### 6.1 Hydraulic system

The piping must be designed and manufactured to limit pressure drops as much as possible, i.e. optimise performance of the system.

Keep the following parameters to a minimum:

- overall length
- number of bends
- number of vertical changes of direction

### 6.2 Water quality

The water quality must be checked by qualified personnel.

Water with inadequate characteristics can cause:

- pressure drop increase
- reduces energy efficiency
- increased corrosion potential

Water features:

- within the limits indicated by table

Provide a water treatment system if values fall outside the limits.

### 6.3 Cleanliness

Before connecting the water to the unit, clean the system thoroughly with specific products effective to remove residues or impurities that may affect functioning. Existing systems must be free from sludge and contaminants and protected against build-ups.

### 6.4 New systems

In case of new installations, it is essential to wash the entire installation (with the circulator uninstalled) before commissioning the central installation. This removes residues of the installation process (welding, waste, joint products...).

The system must then be filled with clean high-quality tap water.

### 6.5 Existing systems

If a new unit is installed on an existing system, the system must be rinsed to avoid the presence of particles, sludge and waste.

The system must be drained before installing the new unit.

Dirt can be removed only with a suitable water flow.

Particular attention must also be paid to “blind spots” where a lot of dirt can accumulate due to the reduced water flow.

If, after rinsing, the quality of the water is still unsuitable, a few measures must be taken to avoid problems.

An option to remove pollutants is to install a filter.



The warranty does not cover damages caused by limestone formations, deposits and impurities from the water supply and/or from failure to clean the systems.

Water component for corrosion limit on Copper	
PH (25°C)	7,5 ÷ 9,0
SO4--	< 100
HCO3- / SO4--	> 1
Total Hardness	8 ÷ 15 °f
Cl-	< 50 ppm
PO4 3-	< 2,0 ppm
NH3	< 0,5 ppm
Free Chlorine	< 0,5 ppm
Fe3 +	< 0,5 ppm
Mn++	< 0,05 ppm
CO2	< 50
H2S	< 50 ppb
Oxygen content	< 0,1 ppm
Sand	10 mg/L
Ferrite hydroxide Fe3O4 (black)	Dose < 7.5 mg/L 50% of mass diameter < 10 µm
Iron oxide Fe2O3 (red)	Dose < 7.5mg/L Diameter < 1 µm
Electrical conductivity (µS/cm)	<500
Sodium nitrate (mgNaNo3/l)	<100
Alkalinity(mgCaCo3/l)	<100
Copper (mgCu/l)	<1,0
Sulphide ion (S-/l)	None
Ammonium ion (mgNH4+/L)	<1,0
Silica (mgSiO2/l)	50
Max Ethylene, Propylene glycol	50%
Nitrates	<100
Free&aggressive Carbonic Acid	<5

### 6.6 Risk of freezing

If the unit or the relative water connections are subject to temperatures close to 0°C:

- mix water with glycol, or
- safeguard the pipes with heating cables placed under the insulation, or
- empty the system in cases of long non-use

### 6.7 Anti-freeze solution

The use of an anti-freeze solution results in an increase in

% GLYCOL ETHYLENE / PROPYLENE BY WEIGHT		5%	10%	15%	20%	25%	30%	35%	40%	45%	50%
Freezing temperature	°C	-2	-3.9	-6.5	-8.9	-11.8	-15.6	-19.0	-23.4	-27.8	-32.7
Safety temperature	°C	3	1	-1	-4	-6	-10	-14	-19	-23.8	-29.4

### 6.8 Water filter

Must be installed immediately in the water input of the unit, in a position that is easily accessible for cleaning.

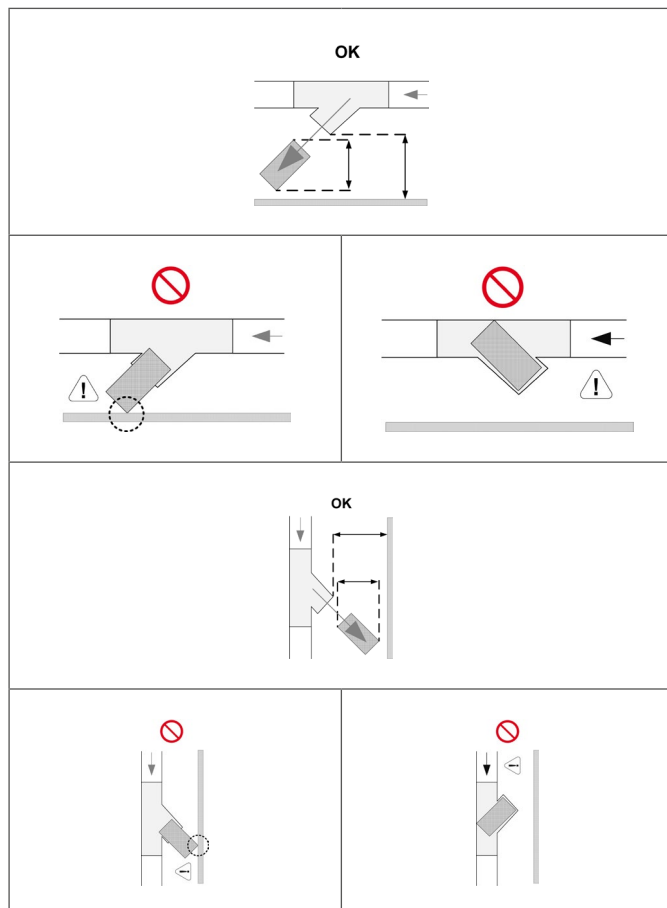

**!** The filter never should be removed, this operation invalidates the guaranty.

The filter must have an adequate mesh to prevent the

pressure drop.

Make sure that the glycol type utilized is inhibited (not corrosive) and compatible with the water circuit components.

Do not use different glycol mixture (i.e. ethylene with propylene).

**!** The unit must always be protected from freeze. Otherwise irreversible damage may occur.

entry of particles greater than that:

plate exchanger (mm)	1,6
shell and tube evaporator (mm)	0,87

### 6.9 Water flow-rate

The design water-flow must be:

- inside the exchanger operating limits (see the TECHNICAL INFORMATION section)
- guaranteed, also with variable system conditions (for example in systems where some circuits are bypassed in particular situations).

If the system capacity is below the minimum flow, bypass the system as indicated in the diagram.

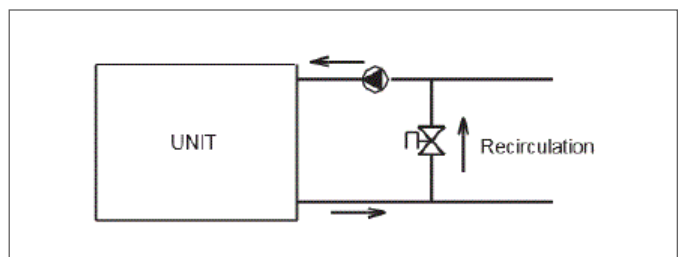

If the system capacity exceeds the minimum flow, bypass the system as indicated in the diagram.

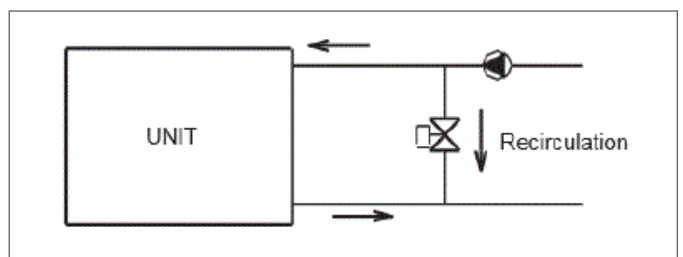

### 6.10 Minimum system water content

Minimum system water volumes are described within

chapter TECHNICAL DATA and they have to be satisfied for a proper functioning of the unit.

### 6.11 Flow Switch

The flow switch must be present to ensure shutdown of the unit if water is not circulating.

It has to be installed in a duct rectilinear part, not in proximity of curves that cause turbulences.

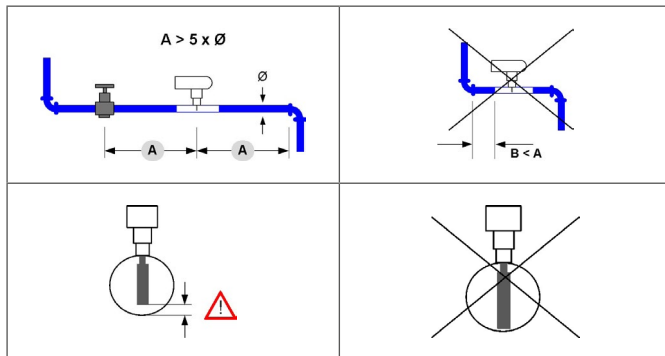

### 6.12 Non-return valve

Provide for the installation of non-return valves (A) in the case of several units connected in parallel.

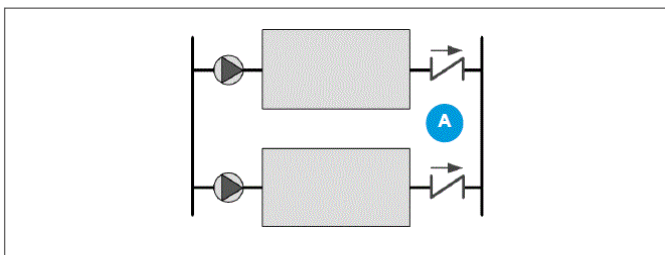

### 6.13 Operation sequence

Before starting the unit pump:

- 1 Close all vent valves in the high points of the unit hydraulic circuit
- 2 close all drain shut-off valves in the low points of the unit's water circuit
  - Exchangers
  - Pumps
  - collectors
- 3 storage tanks
- 4 Carefully wash the system with clean water: fill and drain the system several times.
- 5 use the bypass to exclude the exchanger from the flow (diagram on the previous page)
- 6 fill and empty the system multiple times.
- 7 Apply additives to prevent corrosion, fouling, formation of mud and algae.
- 8 Fill the plant
- 9 do not use the unit pump.
- 10 Execute leakage test.
- 11 Isolate the pipes to avoid heat dispersions and formation of condensate.  
Leave various service points free (wells, vents, etc).

**⚠** Neglecting the washing will lead to several filter cleaning interventions and at worst cases can cause damages to the exchangers and the other parts.

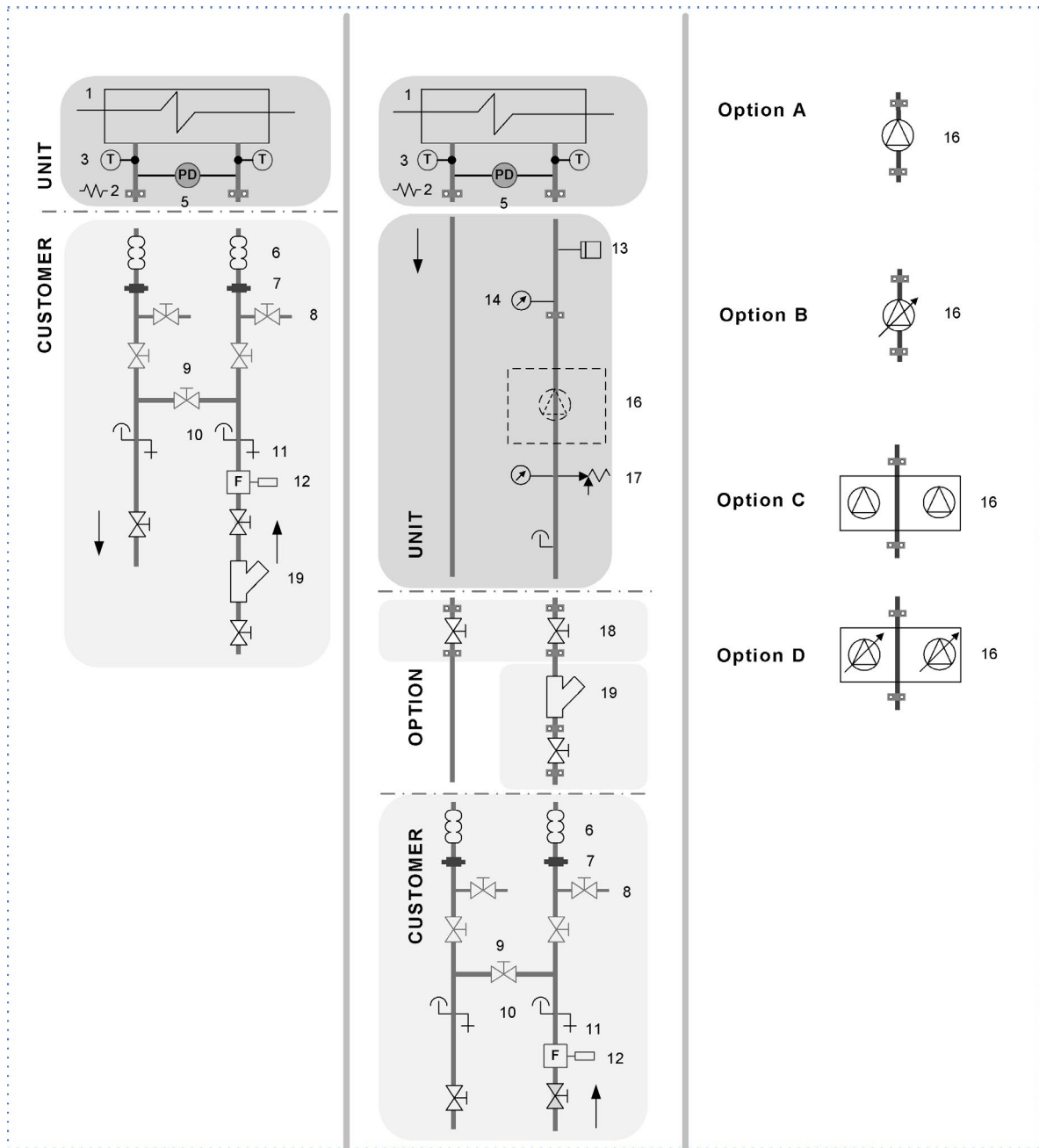

- 1 Exchanger
- 2 Antifreeze heater
- 3 Water temperature probe
- 4 -
- 5 differential pressure switch
- 6 flexible couplings
- 7 piping supports
- 8 Exchanger chemical cleaning

- bypass
- 9 System washing bypass (interlock closed during operation)
- 10 vent
- 11 Drain
- 12 flow switch
- 13 System filling safety pressure switch

- 14 pressure gauge
- 15 --
- 16 Pump
- 17 safety valve
- 18 shut-off valves
- 19 filter

## 6.14 Partial energy recovery

### Option

Configuration which enables the production of hot water free-of-charge while operating in cooling mode, thanks to the partial recovery of condensation heat that would otherwise be disposed of into the external heat source.

The recovery exchanger must always be kept full of water. The lack of water amplifies the noise generated by operation.

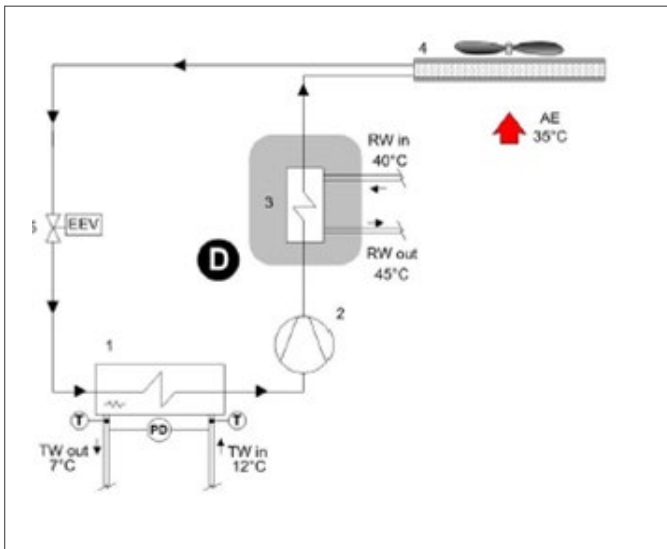

D - Partial recovery device

- 1 Internal exchanger
- 2 Compressors
- 3 Recovery exchanger
- 4 External exchanger
- 5 Electronic expansion valve

TW in - Chilled water inlet

TW out - Chilled water outlet

Rw in - Recovery water inlet

RW out - Recovery water outlet

T - Temperature probe

PD - Differential pressure switch

AE - Outdoor air

When the temperature of the water to be heated is particularly low, it is advisable to install an air flow adjustment valve in the system's water circuit to maintain the outlet temperature at recovery above 35°C and thus prevent condensation of the refrigerant in the partial energy recovery device.

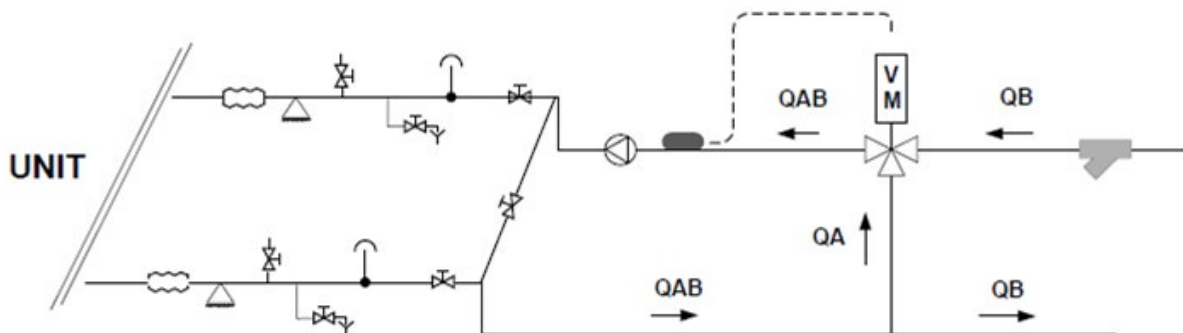

## 7. Electrical connections

The characteristics of the electrical lines must be determined by qualified electrical personnel able to design electrical installations; moreover, the lines must be in conformity with regulations in force.

The protection devices of the unit power line must be able to stop all short circuit current, the value must be determined in accordance with system features.

The power cables and the protection cable section must be defined in accordance with the characteristics of the protections adopted.

All electrical operations should be performed by trained personnel having the necessary qualifications required by the regulations in force and being informed about the risks relevant to these activities.

Operate in compliance with safety regulations in force.

### 7.1 Electrical data

The serial number label reports the unit specific electrical data, included any electrical accessories.

The electrical data indicated in the technical bulletin and in the manual refer to the standard unit, accessories excluded.

The type plate shows the indications foreseen by the standards, in particular:

Voltage

F.L.A.: full load ampere, absorbed current at maximum admitted conditions

F.L.I.: full load input, full load power input at maximum admissible condition

Electrical wiring diagram Nr.

### 7.2 Connections

- 1 Refer to the unit electrical diagram (the number of the diagram is shown on the serial number label).
- 2 Verify that the electrical supply has characteristics conforming to the data shown on the serial number label.
- 3 Before starting work, ensure the unit is isolated, unable to be turned on and a safety sign used.
- 4 Ensure correct earth connection.
- 5 Ensure cables are suitably protected.
- 6 Prevent dust, insects or rodents from entering the electrical panel as they can damage components and cables.
- 7 Prevent noise from escaping from the compressor compartment; seal any openings made.
- 8 Fix the cables: if vacated, they may be subject to tearing.

- 9 The cables must not touch the compressor and the refrigerant piping ( they reach high temperatures ).
- 10 Do not drill holes in the electrical panel.
- 11 Alternatively, restore the IP rating with watertight systems.
- 12 Before power the unit, make sure that all the protections that were removed during the electrical connection work have been restored.

### 7.3 Power supply network requirements

- 1 The short circuit capacity of the line must be less than 15 kA
- 2 The units can only be connected to TN, TT distribution systems
- 3 Voltage 400-3-50 +/-10%
- 4 Phase unbalance < 2%
- 5 Harmonic distortion less than 12% (THDv<12%)
- 6 Voltage interruptions lasting no longer than 3ms and with at least 1 s between each one
- 7 Voltage dips not exceeding 20% of the RMS value, lasting no longer than a single period (50Hz) and with at least 1 s between each dip.
- 8 Earth cable as specified in the table:

Cross-section of the line conductors (mm <sup>2</sup> )	Minimum cross-section of the protective conductor (PE) (mm <sup>2</sup> )
S ≤ 16	S
16 < S ≤ 35	16
S > 35	S/2

### 7.4 Signals / data lines

Do not exceed the maximum power allowed, which varies, according to the type of signal.

Lay the cables far from power cables or cables having a different voltage and that are able to emit electromagnetic disturbances.

Do not lay the cable near devices which can generate electromagnetic interferences.

Do not lay the cables parallel to other cables, cable crossings are possible, only if laid at 90°.

The type of cable must be suitable for RS-485 serial data communication.

A 3-pole shielded bus cable is required.

The data transmission bus cable must be verified according to the type of installation in which it will be

placed and must comply with local standards.

The bus cable must comply with non-prescribed local electrical standards (e.g. insulation, voltages, flame propagation, etc.).

The cable shield must be grounded at a single point free from disturbances.

In order to ensure correct communication, the earth

connection of the shield can also be configured differently depending on the area and the types of interference.

Allowed topology: daisy-chain (enter and exit).

Other types such as “ring” or “star” are not allowed.

Do not use cable lugs on the communication bus.

### 7.5 Power line inlet.

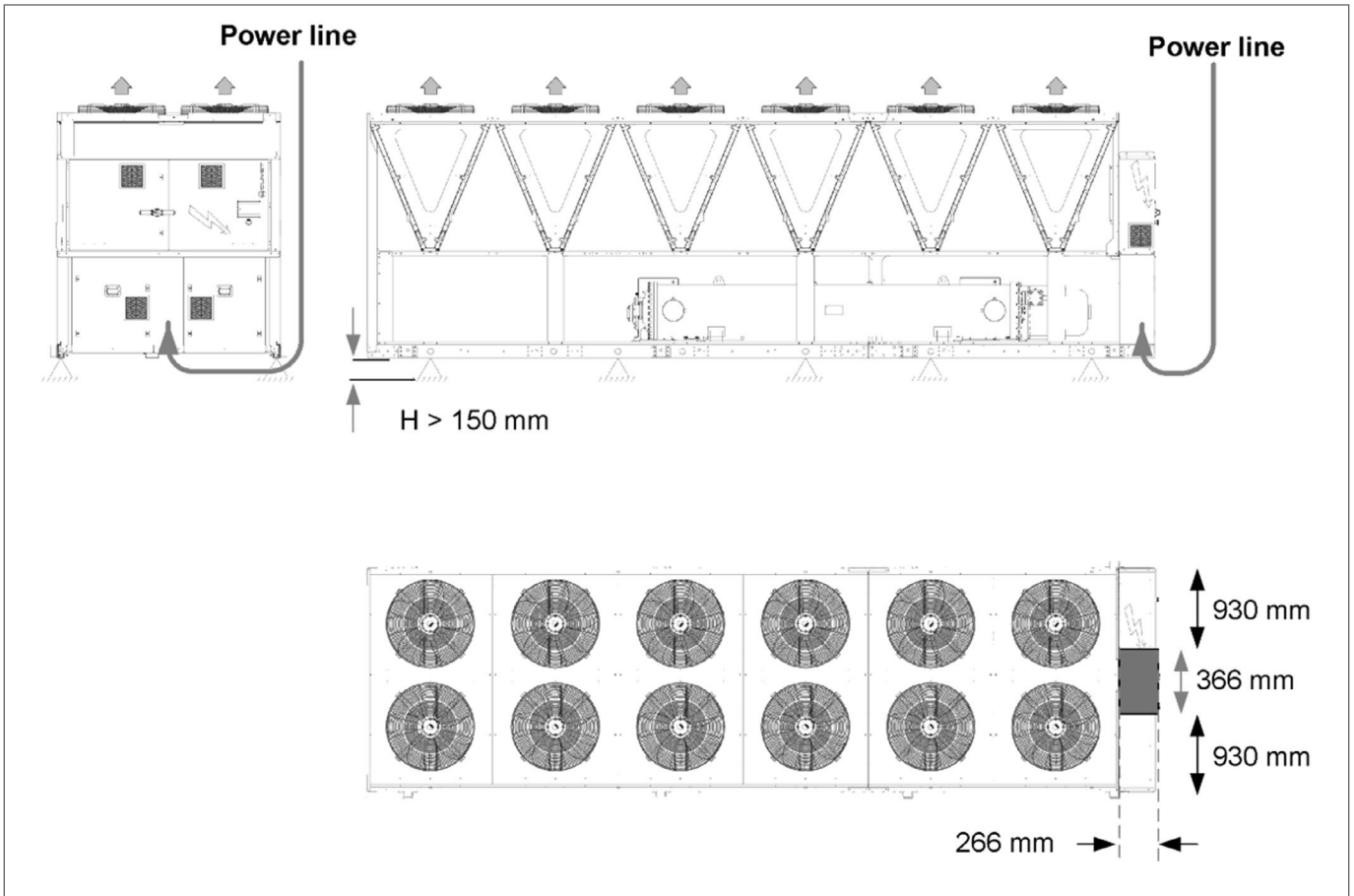

### 7.6 Remote ON-OFF

Do not perform short On-Off cycles.

Do not use the remote On-Off with a thermoregulation function.

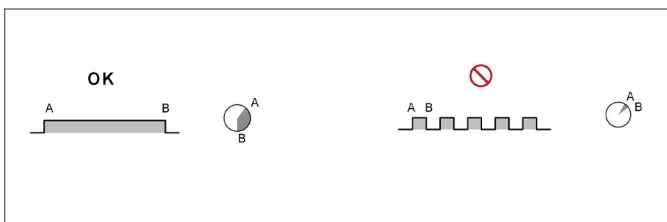

### 7.7 Electrical panel

Do not drill holes in the electrical panel.

Alternatively, restore the IP rating with watertight systems.

7.8 Connections performed by Customer

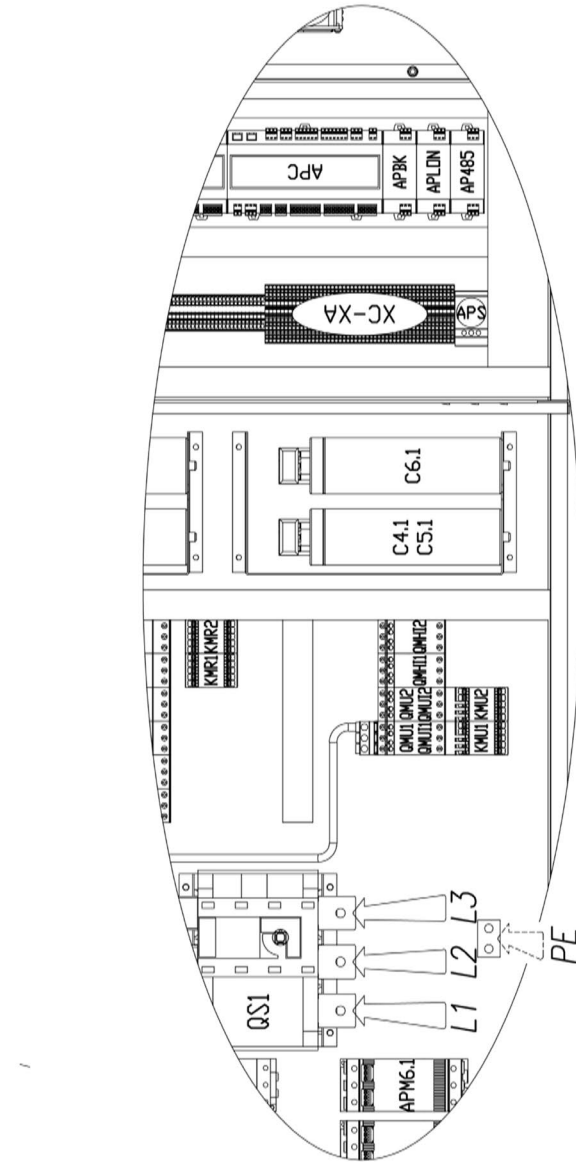

<b>ALM</b>	segnalazione blocco cumulativo cumulative block signal Signalisation bloqué cumulativo Sammelterminalsicherung señalización bloqueo cumulativo	
<b>HLC1-HLC4</b>	lampada di segnalazione stato compressore compressor status signal lamp lampe de signalisation état compresseur Signalamppe Verlichterzustand Lampara de señalización estado compresor	
<b>HLR</b>	lampada di segnalazione allarme resistenza quadro elettrico Alarm signal lamp, resistance electrical panel lampe de signalisation alarme résistance du cabinet Alarm Signalamppe Widerstand Schrank Señal de alarma de la lámpara de resistencia del gabinete	<b>RAQEL1</b> 475...535 P-1: 35.0
<b>SA1</b>	selettore on/off remoto remote on/off selector selektor Ein/Aus selektor on/off remoto	
<b>SA1.1</b>	selettore abilitazione secondo set-point second set-point enabling switch Wechselschalter 2. Sollwert selektor habilitación segundo set-point	
<b>SA6</b>	selettore richiesta acqua sanitaria sanitary water cycle selector Wasserwechselventil Wasserwechselventil selektor solicitud agua sanitaria	<b>OHP</b> 370...2 P-1: 34.0
<b>SA7</b>	selettore remoto "estate/inverno" remote winter/summer selector selecteur déporté été/hiver selektor remoto verano/invierno	<b>OHP</b> 370...2 P-1: 34.0
<b>SQ1</b>	flussstatistika flow switch contrôleur de débit flujocontrol flujocontrol	
<b>QMP</b>	intermittiva automatica a protezione pompa richiesta resuscitation pump protection automatic device intermittuel automatique de protection pompe resuscitation intermittier automatische pumpenschutzvorrichtung intermittier automatische pumpenschutzvorrichtung	--- 411...1 P-1: 32.0
<b>KMP</b>	contattatore pompa pump contactor contacteur pompe de circulation évaporateur Schutz, Kaltwasserpumpe contactor bomba de circulación evaporador	--- 411...1 P-1: 32.0
<b>APU1</b>	inverter pompa lato utilizzo Pompe côté utilisateur Wechselschalter-Seite, Pumpen Einsatz inverter bomba lado uso	<b>IVFDT</b> 452...5 P-1: 33.0
<b>AP18</b>	demand-limit demand-limit demand-limit demand-limit	<b>DMLO-10</b> 829...4 P-1: 35.0
<b>AP19</b>	Water reset Water reset Water reset Water reset	<b>SPC1</b> 830...1 P-1: 35.0
		<b>SPC2</b> 830...2 P-1: 34.5
		<b>SPC4</b> 830...8 P-1: 35.0

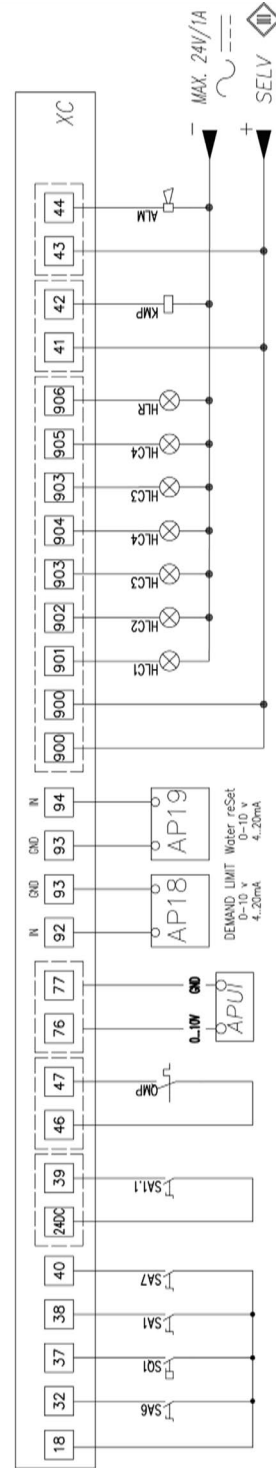

## 7.9 Controller wiring sections

### 7.9.1 Premium version

	<b>90.3</b>	<b>110.4</b>	<b>130.4</b>	<b>145.4</b>	<b>170.4</b>
Min. cable section Cu (mm <sup>2</sup> )	1 x 95	1 x 95	1 x 150	1 x 150	1 x 240
Max. cable section Cu (mm <sup>2</sup> )	1 x 150	1 x 185	1 x 240	1 x 240	1 x 240
Min. bar section (mm <sup>2</sup> )	nd	nd	nd	nd	nd
Max. bar width Cu (mm <sup>2</sup> )	32	32	32	32	40
Tightening torque (Nm)	20	20	20	20	20

	<b>185.5</b>	<b>210.6</b>	<b>225.6</b>	<b>240.6</b>
Min. cable section Cu (mm <sup>2</sup> )	1 x 240	2 x 150	2 x 150	2 x 150
Max. cable section Cu (mm <sup>2</sup> )	1 x 240	2 x 300	2 x 300	2 x 300
Min. bar section (mm <sup>2</sup> )	nd	2 x 30 x5	2 x 30 x5	2 x 30 x5
Max. bar width Cu (mm <sup>2</sup> )	40	50	50	50
Tightening torque (Nm)	20	20	20	20

### 7.9.2 Excellence version

	<b>80.3</b>	<b>100.4</b>	<b>115.4</b>	<b>130.4</b>	<b>550.4</b>
Min. cable section Cu (mm <sup>2</sup> )	1 x 95	1 x 95	1 x 95	1 x 150	1 x 240
Max. cable section Cu (mm <sup>2</sup> )	1 x 150	1 x 185	1 x 185	1 x 240	1 x 240
Min. bar section (mm <sup>2</sup> )	nd	nd	nd	nd	nd
Max. bar width Cu (mm <sup>2</sup> )	32	32	32	32	40
Tightening torque (Nm)	20	20	20	20	20

	<b>170.4</b>	<b>185.5</b>	<b>210.6</b>	<b>225.6</b>	<b>240.6</b>
Min. cable section Cu (mm <sup>2</sup> )	1 x 240	1 x 240	2 x 150	2 x 150	2 x 150
Max. cable section Cu (mm <sup>2</sup> )	1 x 240	1 x 240	2 x 300	2 x 300	2 x 300
Min. bar section (mm <sup>2</sup> )	nd	nd	2 x 30 x5	2 x 30 x5	2 x 30 x5
Max. bar width Cu (mm <sup>2</sup> )	40	40	50	50	50
Tightening torque (Nm)	20	20	20	20	20

## 7.10 Computer connection

### Configure PC

- 1 connect PC to electronic module with LAN cable
- 2 check in the taskbar that the connection is active
- 3 open Control Panel and select Network and sharing centre
- 4 select Modify board setting
- 5 select Local area network (LAN) connection
- 6 select Internet protocol version 4 (TPC/IPV4) and press the Property button
- 7 set IP address 192.168.1.100
- 8 set Subnet mask as 255.255.255.0
- 9 confirm (OK)
- 10 press Windows START button
- 11 write cmd
- 12 write Ping 192.168.1.42
- 13 check that a response string is given
- 14 open a browser (Chrome, Firefox, etc.)
- 15 write http://192.168.1.42
- 16 Userid = WEB
- 17 Password = SBTAdmin!

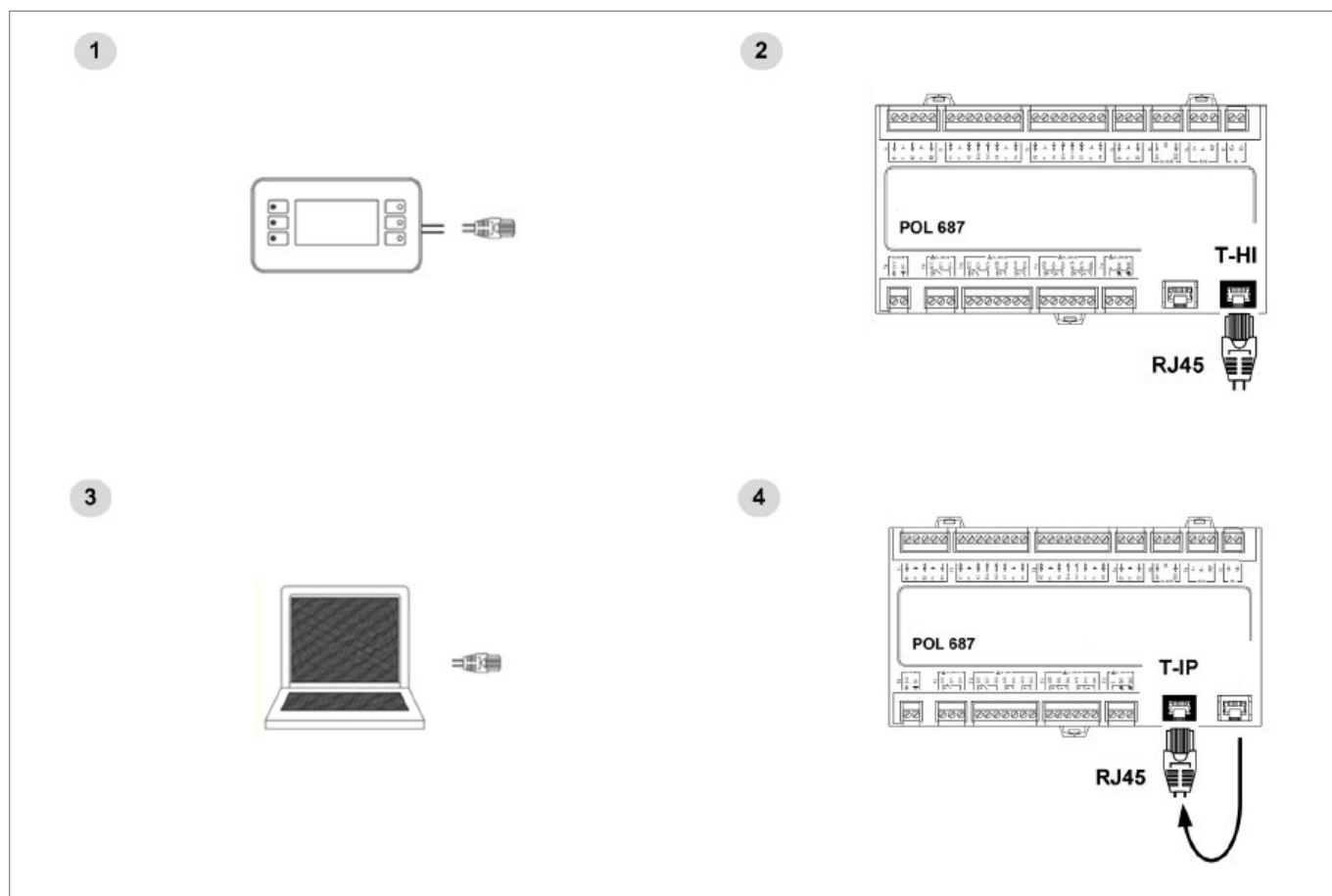

- 1 Standard keypad
- 2 RJ45: standard connection
- 3 PC-not supplied
- 4 PC connection, shift RJ45 from T-HI to T-IP

## 7.11 Remote control

Option

- 1 Distance up to 350 m
- 2 Distance up to 700 m

- A User interface
- B=B1 KNX bus, max 350 m  
shielded twisted pair  $\varnothing$  0.8 mm  
use an EIB/KNX marked cable
- C PSX - Mains power output  
power output N125/11 5WG1 125-1AB11
- C1 AC 120...230V, 50...60Hz
- D KNX bus, max 350 m

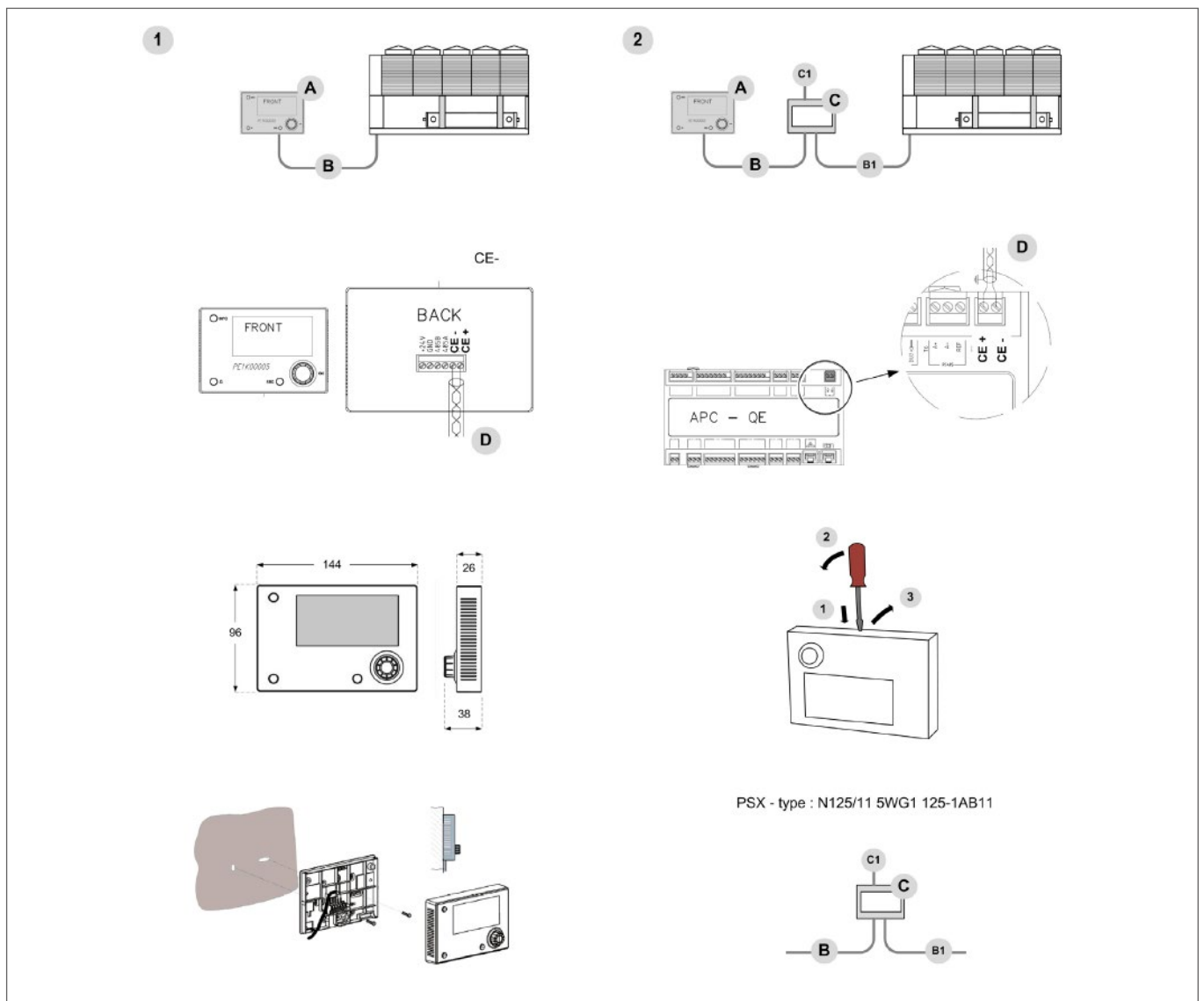

7.12 Modbus - RS485

Option

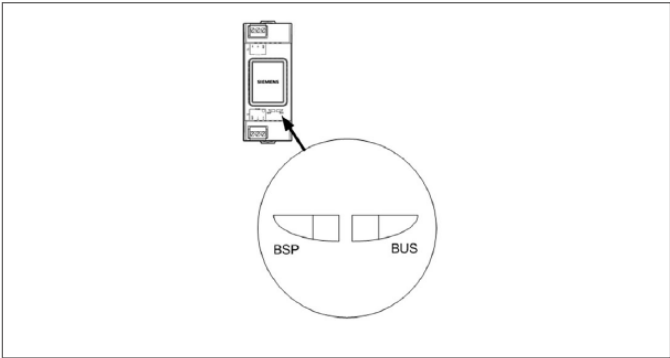
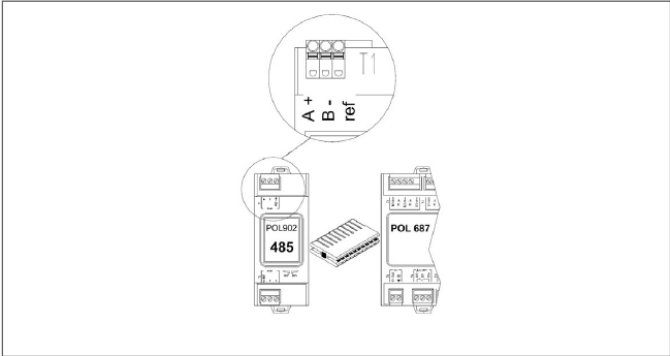

<b>BSP LED</b>	<b>communication with AP1 module</b>
green	communication ok
yellow	software ok but communication with AP1 down
red	flashing: software error steady: hardware error
<b>BUS LED</b>	<b>Modbus communication</b>
green	communication ok
yellow	startup / 1 canal not communicating
red	communication down

7.12.1 Modbus / LonWorks / cable requirements

- Pair of twisted and shielded conductors
- Conductor cross-section 0,22mm<sup>2</sup>...0,35mm<sup>2</sup>
- Rated power between conductors < 50 pF/m
- Nominal impedance 120 Ω
- Recommended cable BELDEN 3106A

- Every RS485 serial line must be set up using the 'In/Out' bus system.
- Other types are not allowed.

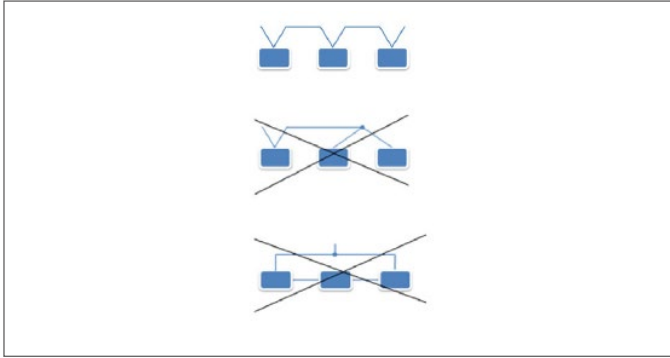

- The difference in potential between the earth of the two RS485 devices that the cable shielding needs to be connected to must be lower than 7 V
- There must be suitable arresters to protect the serial lines from the effects of atmospheric discharges
- A 120 ohm resistance must be fitted on the end of the serial line. Alternatively, when the last serial board is equipped with an internal terminator, it must be enabled using the specific jumper or dip switch.
- The cable must have insulation features and non-flame propagation in compliance with national regulation.
- The RS485 serial line must be kept as far away as possible from sources of electromagnetic interference.

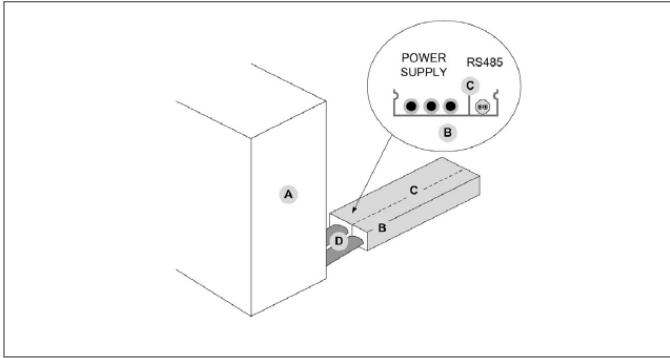

- A Unit
- B Metal conduit
- C Metal septum
- D Metal-lined sheath (sleeve)

### 7.13 LonWorks

Option

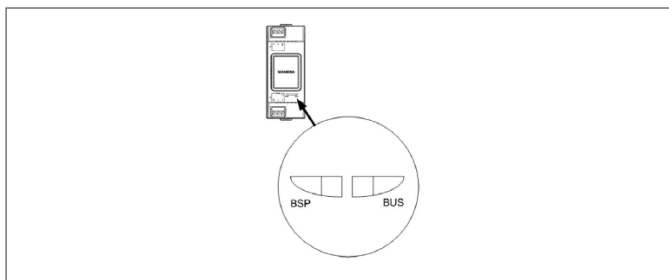
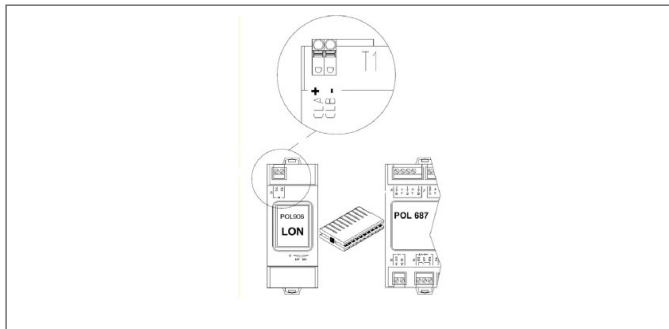

BSP LED	communication with AP1 module
green	communication ok
yellow	software ok but communication with AP1 down
red	flashing: software error steady: hardware error
BUS LED	LonWorks communication
green	ready to communicate
yellow	startup
red	flashing: communication not possible communication down

#### LONWORK CABLE TYPE

Echelon allows three cable types for channel type TP/FT-10, including the Category 5 network cable used commonly in building automation and control (TIA 568A Cat-5).

#### CAT-5 SPECIFICATIONS

Unshielded cable, twisted pair with at least 18 beats per meter:

- Cross-sectional area min  $\varnothing 0.5\text{mm}^2$
- operating capacity between two wires of a pair < 46 nF/km
- capacity pair to ground, asymmetric. < 3,3 nF/km
- impedance 100 +/- 15% @ f > 1 MHz
- DC loop resistance < 168  $\Omega$

### 7.14 BACnet IP

Option

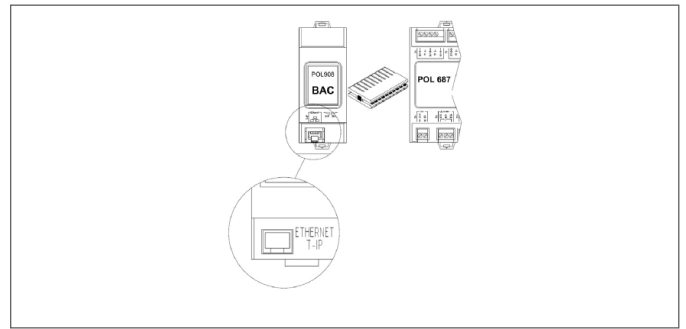

Ethernet 10/100 Mbit(IEEE 8025.3U)

RJ45, 8 pins

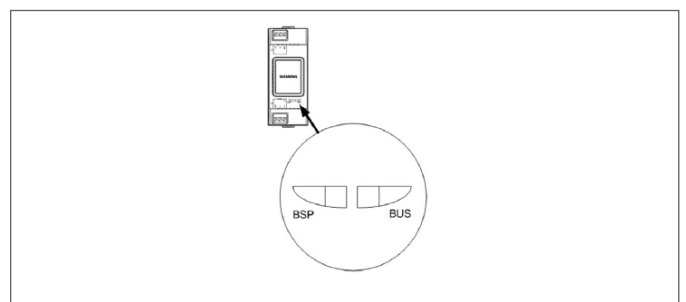

BSP LED	communication with AP1 module
green	communication ok
yellow	software ok but communication with AP1 down
red	flashing: software error steady: hardware error
BUS LED	BACnet communication
green	ready to communicate
yellow	startup
red	BACnet server down restart after 3 sec

### 715 Ecoshare

#### Option

The Master unit (identified by the LNAddress parameter = 1) controls the network.

The network can be extended to a maximum of 8 units (1 master – 7 slaves).

The master manages connected units in order to obtain:

- The coordination of operation (Mode, status, setpoint and signal commands of the DemandLimit function are transmitted from the Master unit to the Slave units).
- The rotation of unit operating priorities based on their wear (total number of hours of operation).
- The management of one or more units on standby. The units put on standby are always the ones showing more wear. The units on standby are rotated with daily frequency or when an alarm is triggered on the units in

operation.

#### Connection requirements

- Maximum length of the bus line: 700 m
- Maximum distance between 2 units: 300 m
- Type of cable: shielded twisted pair, Ø 0,8 mm, use an EIB/KNX marked cable
- Possible connections: Tree, star, in/out bus, mixed
- It is not possible to use a loop connection
- No end-of-line resistance or terminator required
- There must be suitable arresters to protect the serial lines from the effects of atmospheric discharges
- The data line must be kept separate from the power conductors or powered at different voltages and away from possible sources of electrical interference

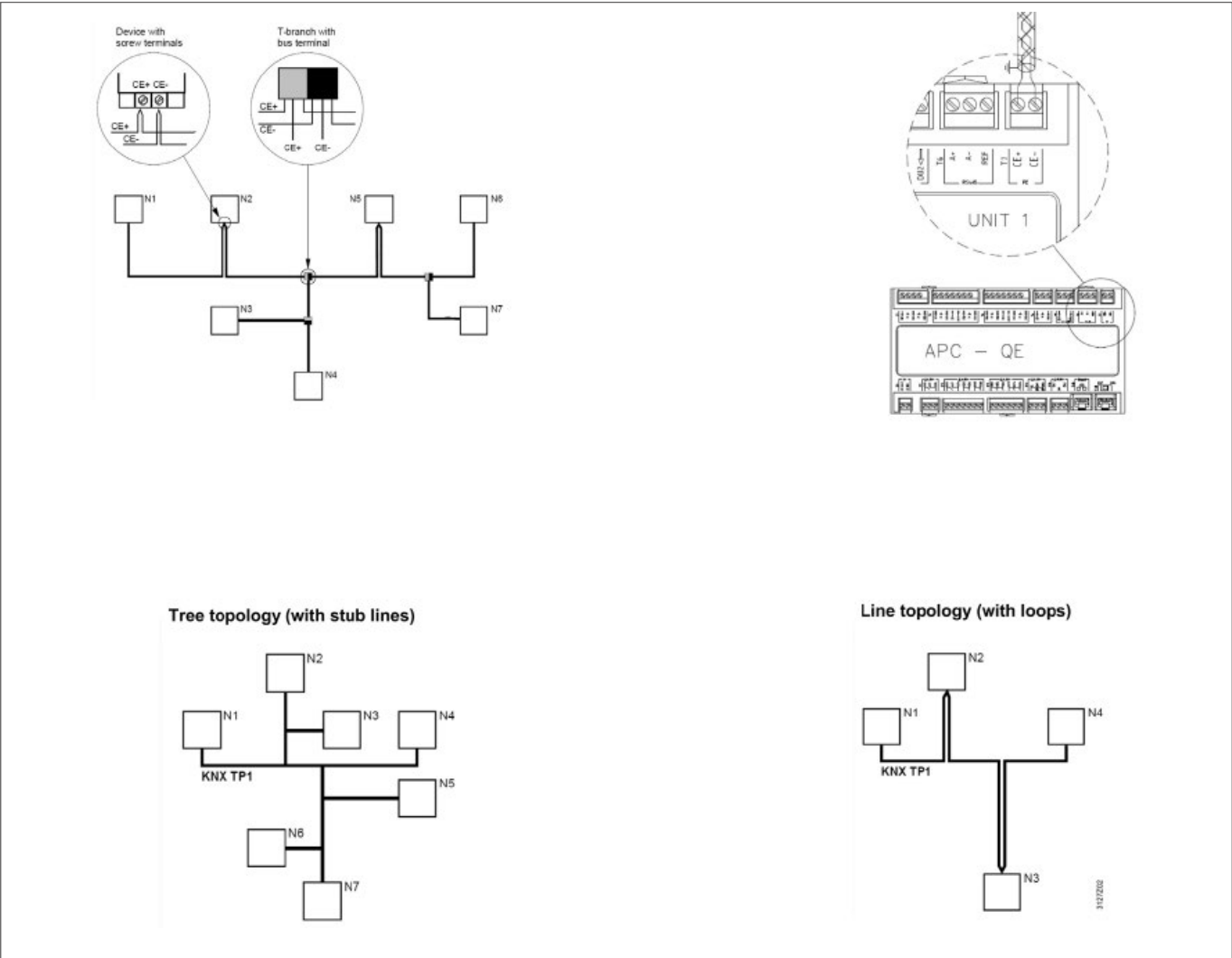

### Type A configuration

Parameter P0658:TypeRegMS = 0 and P0702:KRegMS=0

The pumps of all units are active.

On each unit, a different setpoint is set

The value is calculated starting from the setpoint set in the master unit, adding/removing, depending on the operating mode (cold/hot), an offset that can be parameterised.

Example:

Master Mode = Cold

Setpoint set in the Master = 7.0 °C

Offset = 0.5 °C

Slave 2 (less wear): Setpoint = 7.0 °C

Slave 3 (wear less than Slave 2): SetPoint = 7.5 °C

Master (wear less than Slave 3): Setpoint = 8.0 °C

Slave 1 (more wear): Setpoint = 8.5 °C

#### Status and mode of the Slave units are controlled by the Master

Heat load

Each unit works independently to fulfil the heat load based on the Setpoint assigned to it by the Master.

### Type B configuration

Parameter P0658:TypeRegMS = 1 and P0702:KRegMS=0

The pumps of all units are active.

On each unit, a different setpoint is set:

The value is calculated starting from the setpoint set in the master unit, adding/removing, depending on the operating mode (cold/hot), an offset that can be parameterised.

Example:

Master Mode = Cold

Setpoint set in the Master = 7.0 °C

Offset = 0.5 °C

Slave 2 (less wear): Setpoint = 7.0 °C

Slave 3 (wear less than Slave 2): SetPoint = 7.5 °C

Master (wear less than Slave 3): Setpoint = 8.0 °C

Slave 1 (more wear): Setpoint = 8.5 °C

#### Status and mode of the Slave units are controlled by the Master

Heat load

The heat load is distributed by the Master on all the units, thus fulfilling the optimal step of each unit prior to activating the next one.

The activation sequence is calculated based on

considerations on the optimal distribution of the utility load and on the wear of the units (Less wear = machine with priority).

PLEASE NOTE: the distribution of the steps on the circuits of each individual unit is carried out by the device that manages internal distribution of the individual unit (this ensures an optimal distribution for each unit on the various circuits).

### Type C configuration

Parameter P0658:TypeRegMS = 2 and P0702:KRegMS=0

Only the pumps of the units called to operate are activated.

Slave units mode controlled by the Master

The units are controlled only if they have to deliver power.

On each unit, a different setpoint is set:

The value is calculated starting from the setpoint set in the master unit, adding/removing, depending on the operating mode (cold/hot), an offset that can be parameterised.

Example:

Master Mode = Cold

Setpoint set in the Master = 7.0 °C

Offset = 0.5 °C

Slave 2 (less wear): Setpoint = 7.0 °C

Slave 3 (wear less than Slave 2): SetPoint = 7.5 °C

Master (wear less than Slave 3): Setpoint = 8.0 °C

Slave 1 (more wear): Setpoint = 8.5 °C

#### Heat load.

The heat load is distributed by the Master on all the units, thus fulfilling the optimal step of each unit prior to activating the next one.

The activation sequence is calculated based on considerations on the optimal distribution of the utility + recovery load and on the wear of the units (Less wear = machine with priority).

PLEASE NOTE: the distribution of the steps on the circuits of each individual unit is carried out by the device that manages internal distribution of the individual unit (this ensures an optimal distribution for each unit on the various circuits).

Path: Main Menu / Unit parameters / Ecoshare		
Parameters	Short description	Description
P0655	LNInstalledUnits	Number of units installed/connected in Ecoshare 1 – 8
P0656	LNStandByUnits	Number of units on standby 0 – 6
P0657	LNOffset	Temperature Offset to be added to the unit setpoint
P0658	TypeRegMS	Ecoshare adjustment type 0 – 2
P0659	LNAddress	Unit address 1 – 8 (1 = MASTER)
P0664	LNOffsetRec	Offset for setpoint shift recovery side 0 – 15 °C
P0702	KRegMS	Activates eco share new mode (1 only on multifunctional unit)

## 8. Start-up

The operations indicated should be performed by qualified technicians with specific training on the product.

Upon request, the service centres can perform the start-up.

The electric, hydraulic connections and the other work of the system are the responsibility of the installer.

Please agree upon the start-up date with the service centre with sufficient advance.

Before checking, please verify the following:

- the unit should be installed properly and in compliance with this manual
- the electrical power supply line should be isolated at the beginning
- the unit isolator is open, locked and equipped with the suitable warning
- make sure no voltage is present



After turning off the power, wait at least 5 minutes before accessing to the electrical panel or any other electrical component.



Before accessing check with a multimeter that there are no residual voltages.

## 8.1 Start-up sequence

For details refer to the different manual sections.

	<b>Unit OFF power supply</b>
1	safety access
2	suitable frame to withstand unit weight + people weight
3	functional spaces
4	air flow: correct return and supply (no bypass, no stratification)
5	considered level to be reachable by snow
6	considered main winds: there are deflectors, windbreaks, suitable anchor system
7	lack of chimneys / corrosive atmospheres / pollutants
8	structure integrity
9	fans run freely
10	unit on vibration isolators
11	unit on level ground
12	there is condensate drainage (only for heat pump units)
13	unit input water filter + shut-off valves for cleaning
14	hydraulic connections as per recommended diagram
15	expansion tank (indicative volume = 10% system content)
16	minimum system water content
17	cleaned system
18	loaded system + corrosion inhibitor
19	antifreeze protections: glycol solution + possible heating cable
20	system under pressure + vented
21	refrigerant circuit visual check
22	earthing connection
23	power supply features
24	Customer connections: electrically connected, configured

## 8.2 Start-up sequence

For details refer to the different manual sections.



Before powering the unit, carry out a leak test with suitable instrumentation



	<b>Unit ON power supply</b>
1	compressor crankcase heaters operating at least since 8 hours
2	off-load voltage measure
3	phase sequence check
4	pump manual start-up and flow check
5	shut-off valve refrigerant circuit open
6	unit ON
7	load voltage measure
8	verify the lack of bubbles in the liquid light (if applicable)
9	check of all fan operating: no abnormal noises or vibrations
10	measure return and supply water temperature
11	measure super-heating and sub-cooling
12	run tests in both heat and cool mode (only for heat pump units)
13	check no anomalous vibrations are present
14	climatic curve personalization
15	scheduling customisation
16	check that all panels are closed and fastened properly
17	complete and available unit documentation
18	Set the unit in accordance with the customer's requirements (setpoint, operating mode, scheduler, ECO etc.).
19	Fill in the unit's booklet

### 8.3 Refrigeration circuit

- 1 Check carefully the refrigeration circuit: the presence of oil stains can mean leakage caused by transportation, movements or other).
- 2 Verify that the refrigeration circuit is in pressure: Using the unit manometers, if present, or service manometers.
- 3 Make sure that all the service outlets are closed with proper caps; if caps are not present a leak of refrigerant can be possible.
- 4 Open the valves of the refrigeration circuit, if there are any.

### 8.4 Electric Circuit

- 1 Verify that the unit is connected to the ground plant.
- 2 Check the conductors are tightened as the vibrations caused by handling and transport might cause these to come loose.
- 3 Connect the unit by closing the sectioning device, but leave it on OFF.
- 4 Check the voltage and line frequency values which must be within the limits: 400-3-50 +/-10%
- 5 Check and adjust the phase balance as necessary: it must be lower than 2%

 Working outside of these limits can cause irreversible damages and voids the warranty.

### 8.5 Water circuit

- 1 Before realising the unit connection make sure that the hydraulic system has been cleaned up and the clearing water has been drained.
- 2 Check that the hydraulic circuit has been filled and pressurised.
- 3 Check that the shut-off valves in the circuit are in the "OPEN" position.
- 4 Check that there isn't air in the circuit, if required, evacuate it using the air bleed valve placed in the system high points.
- 5 When using antifreeze solutions, make sure the glycol percentage is suitable for the type of use envisaged.

 Neglecting the washing will lead to several filter cleaning interventions and at worst cases can cause damages to the exchangers and the other parts.

### 8.6 Compressor casing resistances

Connect the oil resistances on the compressor crankcase at least 8 hours before the compressor is to be started:

- at the first unit start-up
  - after each prolonged period of inactivity
- 1 Power the heaters: isolator switch on 1 / ON.
  - 2 Check the power consumption of the resistances to make sure that they are functioning.
  - 3 Start only if the temperature of the compressor casing on the bottom is at least 10°C higher than the outdoor temperature.

 Do not start the compressor with the crankcase oil below operating temperature.

### 8.7 Voltages

Check that the air and water temperatures are within the operating limits.

Start the unit.

With unit operating in stable conditions, check:

- Power supply voltage
- Total absorption of the unit
- Absorption of the single electric loads

## 8.8 Options

Menu accessible only after having entered the password.

Access reserved only to specifically trained personnel.

Changing the parameters can cause irreversible damage.

Path: Main menu / Unit parameters / Options		
Parameters	Short description	Description
P0002	En DemandLimit	Enable Demand Limit enabling: 0 = disabled, 1 = analogue input, 2 = parameter
P0003	En WaterReset	Water reset enabling: 0 = Off, 1 = Cold, 2 = Hot, 3 = hot and cold
P0036	En CompExt	Climatic curve enabling: 0 = Off, 1 = Cold, 2 = Hot, 3 = hot and cold
P0050	En 2SetPoint	2SetPoint enabling: 0 = Off, 1 = On
P0051	PrioritaCmd	Priority of status and unit mode commands: Local [0] = Priority to local commands, BMS [1] priority to commands from system supervisor
P0053	En DIOn-Off	Remote ON-OFF enabling: 0 = Off, 1 = On
P0090	TypeDL	Inlet signal type: 0 = 0-10V; 1 = 4-20mA
P0091	TypeWR	Inlet signal type: 0 = 0-10V; 1 = 4-20mA

### 8.9 Demand limit

Menu accessible only after having entered the password.

**i** Access reserved only to specifically trained personnel.

**!** Changing the parameters can cause irreversible damage.

The function allows you to limit the unit’s power input with an external 0-10Vcc or 4-20mA signal.

The higher the signal, the lower the number of compressors available to fulfil the thermal demand.

Only if P0002 En DemandLimit ≠ 0

Path: Main menu / Unit parameters / Options

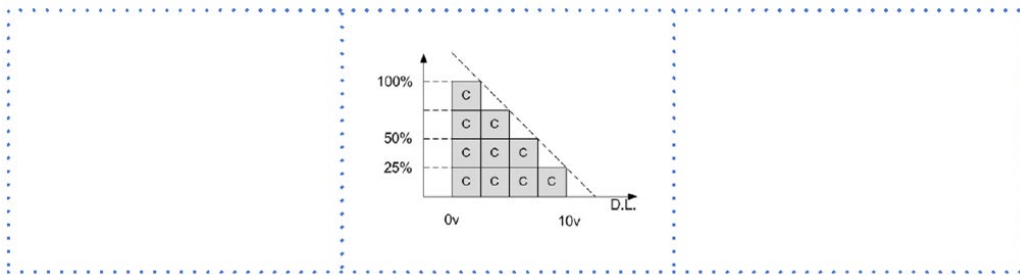

Step	Action	Menu - Variable	Buttons		Display
1	Press for 3 sec		√		Password
2	Set	Password	▲	√	
3	Press		i		Main menu
4	Select	Unit parameters	▼	√	Unit parameters
5	Select	Setpoint	▼	√	Setpoint
6	Select	Demand limit	▼	√	
7	Set	Demand limit	▲	▼	
8	Confirm		√		
9	Press for 3 sec		⌂		
10	Select	Local connection	√		

Path: Main menu / Unit parameters / Options

Parameters	Short desc.	Description
P0090	TypeDL	Inlet signal type: 0=0-10V; 1=4-20mA
Path: Main menu / Unit parameters / Options		
P0200	set demand limit	Demand limit % value setting parameter

### 8.10 Climatic TExt

Menu accessible only after having entered the password.

**i** Access reserved only to specifically trained personnel.

**!** Changing the parameters can cause irreversible damage.

The setpoint defined by the climatic curve and Water Reset is displayed

Only if P0036: En Climatica = 1

Path: Main menu / Unit parameters / Options

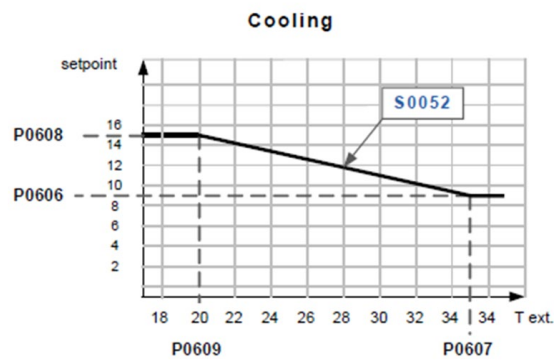

Step	Action	Menu - Variable	Buttons	Display
1	Press for 3 sec		√	Password
2	Set	Password	▲ √	
3	Press		i	Main menu
4	Select	Unit parameters	▼ √	Unit parameters
5	Select	Climatic TExt	▼ √	Climatic TExt (pwd)
6	Select	Parameter	▼ √	
7	Set	Demand limit	▼ ▲	
8	Confirm		√	
9	Press for 3 sec		⏏	
10	Select	Local connection	▼ √	

Path: Main menu / Unit parameters / Options		
Parameters	Short desc.	Description
P0606	CSptLow	value of set Cool for outdoor air greater than P0607
P0607	AirAtSetPointLowC	value of outdoor air for set Cool equal to the parameter P0606
P0608	CSptHigh	value of set Cool for outdoor air lower than P0609
P0609	AirAtSetPointHighC	value of outdoor air for set Cool equal to the parameter P0609

### 8.11 Water reset

Menu accessible only after having entered the password.

**i** Access reserved only to specifically trained personnel.

**!** Changing the parameters can cause irreversible damage.

The function allows you to limit the unit's power input with an external 0-10Vcc or 4-20mA signal.

The setpoint defined by the climatic curve and Water Reset is displayed

Only if P0003: En WaterReset = 1

Path: Main menu / Unit parameters / Options

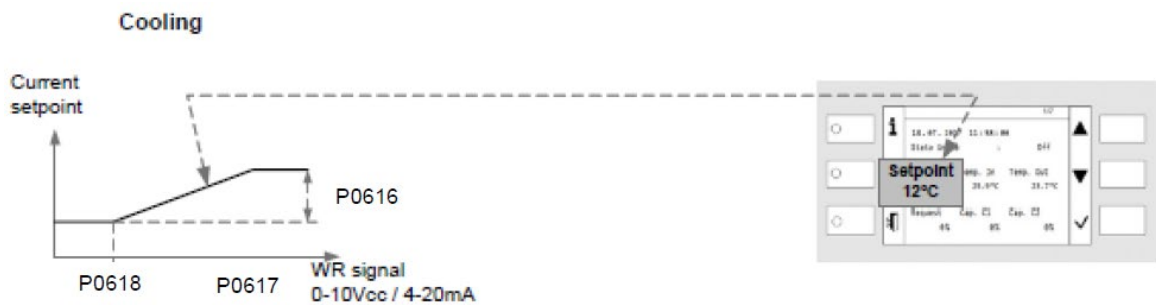

Step	Action	Menu - Variable	Buttons	Display
1	Press for 3 sec		√	Password
2	Set	Password	▼ √	
3	Press		i	Main menu
4	Select	Unit parameters	▼ √	Unit parameters
5	Select	Water reset	▼ √	Water reset
6	Select	Parameter	▼ √	
7	Set	Demand limit	▼ ▲	
8	Confirm		√	
9	Press for 3 sec		⌂	
10	Select	Local connection	√	

Path: Main menu / Unit parameters / Options		
Parameters	Short desc.	Description
P0091	TypeWR	Inlet signal type: 0=0-10V; 1=4-20mA
Path: Main Menu / Unit parameters / Water reset		
P0616	MaxCWRC	Maximum correction to be added to the COOL setpoint
P0617	SWRMaxC	% value of the WR control signal corresponding to the correction of the maximum Cool setpoint
P0618	SWRMinC	% value of the WR control signal corresponding to the correction of the Cool setpoint equal to 0

## 8.12 Reduced load operation

The units are equipped with capacity steps and so can operate with reduced loads.

However, a constant and long reduced load operation with frequent compressor(s) stops and start-ups can cause irreparable damage due to the absence of oil return.

The above-described operating conditions must be considered outside the operating limits.

If the compressor breaks down due to operating in the above-mentioned conditions, the warranty shall no longer be valid and CLIVET spa shall not accept any liability.

Periodically check the average operating times and frequency of compressor start-ups: indicatively the minimum heat load must be such as to require a compressor to operate for at least ten minutes.

If average times are close to this limit, take appropriate corrective actions, e.g. increase the water content of the system, which is not sufficient in this application.

## 8.13 Checking the evaporator water flow-rate

Check that the difference between the exchanger inlet and outlet water temperature corresponds to the power according to this formula:

- unit cooling capacity (kW)  $\times$  860 =  $\Delta t$  (°C)  $\times$  flow-rate (L/h)
- The cooling capacity is shown in the GENERAL TECHNICAL DATA table in this manual referring to specific conditions, or in the tables on
- COOLING PERFORMANCE in the TECHNICAL BULLETIN referring to various conditions of use.

Check for water side exchanger pressure drops:

- determine the water flow-rate
- measure the difference in pressure between exchanger inlet and outlet and compare it with the graph on WATER SIDE EXCHANGER PRESSURE DROPS

The measurement of pressure will be easier if pressure gauges are installed as indicated in the RECOMMENDED WATER CONNECTION DIAGRAM.

## 8.14 Start-up report

Identifying the operating objective conditions is useful to control the unit over time.

With unit at steady state, i.e. in stable and close-to-work conditions, identify the following data:

- total voltages and absorptions with unit at full load
- absorptions of the different electric loads (compressors, fans, pumps etc)
- temperatures and flows of the different fluids (water, air) both in input and in output from the unit
- temperature and pressures on the characteristic points

of the refrigerating circuit (compressor discharge, liquid, intake)

The measurements must be kept and made available during maintenance interventions.

## 8.15 2014/68/UE PED directive

DIRECTIVE 2014/68/UE PED gives instructions for installers, users and maintenance technicians as well.

Refer to local regulations; briefly and as an example, see the following:

Compulsory verification of the first installation:

- only for units assembled on the installer's building site (for ex. Condensing circuit + direct expansion unit)

Certification of setting in service:

- for all the units

Periodical verifications:

- to be executed with the frequency indicated by the Manufacturer (see the "maintenance inspections" paragraph)

## 9. Control

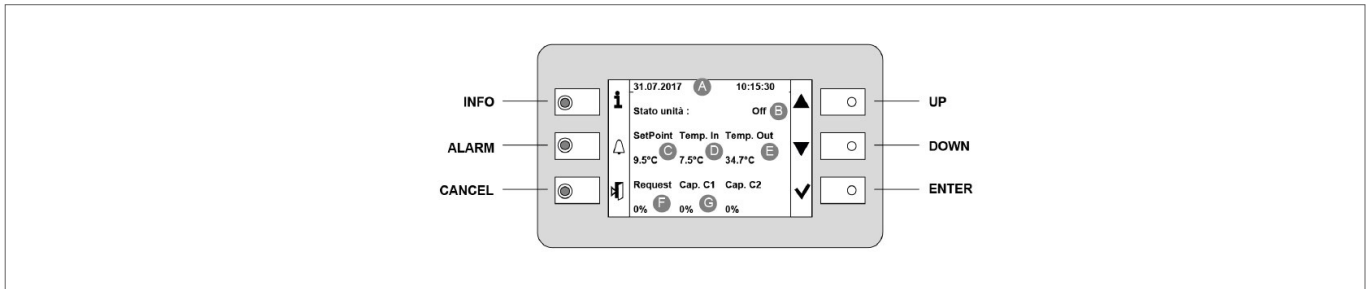

### 9.1 LED

INFO	Not used
ALARM	Flashing / Steady = alarm present
CANCEL	Not used currently







### 9.2 Display

Ref.	Variable	description
A		Date - Time
B	Current Status	On / off / eco / pmp On
C	SetPoint	Control temperature
D	IN temp.	User side water inlet temperature
E	OUT temp.	User side water outlet temperature
F	Request	Capacity demand from temperature controller (including any Demand Limit restriction)
G	C1 cap.	Capacity demand supplied from compressor 1
	C2 cap.	Capacity demand supplied from compressor 2







### 9.3 Buttons

Symbol	Name	description
	Info	Main menu
	Alarm	Displays alarms
	Cancel	Exit, Previous level, Keypad settings
	Up	Increases value
	Down	Decreases value
	Enter	Confirm, Password











## 9.4 Change unit status

Step	Action	Menu - Variable	Buttons		Display
1	Press				Main menu
2	Select	Local status cmd			
3	Set	OFF - ECO - ON - Pump ON			
4	Confirm				
5	Exit				
ON	Compressors enabled				
OFF	Compressors disabled - Antifreeze protections on user side on				
ECO	Compressors enabled - Pumps switched on periodically - Setpoint = EcoCool setpoint				
PMP_ON	Compressors disabled - Pumps on				

## 9.5 Change mode

Step	Display	Action	Menu - Variable	Buttons	
1	Main menu	Press			
2		Select	Local mode cmd		
3		Set	Cool: cooling Heat: heating		
4		Confirm			
5		Exit			

## 9.6 Change setpoint

Step	Action	Menu - Variable	Buttons		Display
1	Press				Main menu
2	Select	Unit parameters			Unit parameters
3	Confirm	Setpoint			
4	Select	Setpoint			
5	Set	Setpoint			
6	Confirm				
7	Exit				

Parameters	Short desc.	Description
P0583	SetPointCooling	Cooling setpoint
P0584	2SetPointCooling	2nd Cooling Setpoint - Enabled from remote start-up
P0855	SetPointEcoCooling	Economic summer SetPoint

## 9.7 Display statuses

Step	Action	Menu - Variable	Buttons		Display
1	Press				Main menu
2	Select	Unit statuses			
3	Select	General, circuit, etc.			
4	Exit				

## 9.8 Scheduler

It is possible to set 6 status changes (Off, Eco, On, Recirculation) for each week day

Step	Action	Menu - Variable	Buttons		Display
1	Press				Main menu
2	Select	Scheduler			Scheduler
3	Select	Day			
4	Select	Time			
5	Set	Event time			
6	Confirm				
7	Select	Value			
8	Set	On / Eco ...			
9	Confirm				
10	Exit				

## 9.9 Scheduler enabling

Step	Action	Menu - Variable	Buttons		Display
1	Press for 3 sec				Password
2	Set	Password			
3	Press				Main menu*
4	Select	Unit parameters			
5	Select	Unit options			
6	Set	P0061 = 1			
7	Press for 3 sec				
8	Select	Local connection			

\* Unit Parameters menu is displayed

## 9.10 Keypad settings

Step	Action	Menu - Variable	Buttons		Display
1	Press for 3 sec				
2	Press				
3	Select				HMI Settings
4	Press				
5	Press				
6	Select	Local connection			

## 9.11 Alarms

 Before resetting an alarm, identify and remove its cause.

 Repeated resets can cause irreversible damage or malfunction to the system.















Alarm display: steps 1-3

Alarm reset: steps 4-10

Example:

+ eE001 Phase monitor: Fault = active alarm

- EE003 User P1 faulty: Ok = alarm reset

Step	Action	Menu - Variable	Buttons		Display
1	Press				Alarm list detail
2	Press				Alarm list
3	Select	Alarm			Alarm list detail
4	Press for 3 sec				Password
5	Set	Enter password			Alarm list detail
6	Press				Alarm list
7	Select	Alarm			
8	Select	Reset			
9	Press for 3 sec				
10	Select	Logoff			

## 9.12 General list of alarms

The alarm code identifies the refrigerant circuit.

Example: ee101 TimeOutModCirc = circuit 1

ee201 TimeOutModCirc = circuit 2

Code	Alarm type
ee, ff, ii	Automatic reset
eE, fF, iI	Automatic reset; after N activations, the alarm becomes manual reset
EE, FF, II	Manual reset

## Alarm list

Code		Description
eE0001	Phase Monitor	Phase monitor input open (off)
ee0003	Pump 1 User-side	Pump protection input open (off)
ee0004	Pump 2 User-side	Pump protection input open (off)
ee0005	Pump 3 User-side	Pump protection input open (off)
eE0008	User-side Inverter Protection	Pump inverter protection input open (off)
EE0010	Master Offline	No communication with the Master unit in the Ecoshare network.
EE0011	Unit 2 in Alarm	Unit with address 2 with generic alarm
EE0012	Unit 2 Offline	No communication with the unit with address 2 in the Ecoshare network.
EE0013	Unit 3 in Alarm	Unit with address 3 with generic alarm
EE0014	Unit 3 Offline	No communication with the unit with address 3 in the Ecoshare network.
EE0015	Unit 4 in alarm	Unit with address 4 with generic alarm
EE0016	Unit 4 Offline	No communication with the unit with address 4 in the Ecoshare network.
EE0017	Unit 5 in alarm	Unit with address 5 with generic alarm
EE0018	Unit 5 Offline	No communication with the unit with address 5 in the Ecoshare network.
EE0019	Unit 6 in alarm	Unit with address 6 with generic alarm
EE0020	Unit 6 Offline	No communication with the unit with address 6 in the Ecoshare network.
EE0021	Unit 7 in alarm	Unit with address 7 with generic alarm
EE0022	Unit 7 Offline	No communication with the unit with address 7 in the Ecoshare network.
EE0023	Unit 8 in Alarm	Unit with address 8 with generic alarm
EE0024	Unit 8 Offline	No communication with the unit with address 8 in the Ecoshare network.
EE0025	Source In Temp. Probe	Electrical connection error with the temperature probe or disconnected cable.
EE0027	User-side In Temp. Probe	Electrical connection error with the temperature probe or disconnected cable.
EE0028	User-side Out Temp. Probe	Electrical connection error with the temperature probe or disconnected cable.
EE0029	External Temp. Probe	Electrical connection error with the temperature probe or disconnected cable.
EE0030	Demand Limit (AI V)	Electrical connection error on Demand Limit connection or disconnected cable and function enabled (0-10v).
EE0031	Water Reset (AI V)	Electrical connection error on Water Reset connection or disconnected cable and function enabled (0-10v).
EE0033	Cabinet Temp.	Electrical connection error with the temperature probe or disconnected cable.
EE0034	2nd Cabinet Temp.	Electrical connection error with the temperature probe or disconnected cable.
EE0050	User-side Diff. Press. Probe	Electrical connection error with the pressure switch or disconnected cable.
ee0054	Recovery Pump 1 Protection	Pump protection input open (off)
ee0055	Recovery Pump 2 Protection	Pump protection input open (off)
ee0056	Recovery Pump 3 Protection	Pump protection input open (off)
eE0057	Recovery Inverter Protection	Pump inverter protection input open (off)
ee0060	MaxT.QE	Electrical connection error with the temperature probe or disconnected cable.
EE0100	TimeOut POL98U_1	Communication error with the I/O peripheral device
EE0101	TimeOut POL98U_2	Communication error with the I/O peripheral device
EE0102	TimeOut POL96U	Communication error with the I/O peripheral device

Code		Description
EE0103	TimeOut POL96U_1	Communication error with the I/O peripheral device
EE0104	TimeOut POL965	Communication error with the I/O peripheral device
EE0105	TimeOutModPOL94U	Communication error with the I/O peripheral device
EE0106	TimeOutModPOL94U_2	Communication error with the I/O peripheral device
EE0107	TimeOutModPOL985	Communication error with the I/O peripheral device
EE0108	TimeOutModPOL985_2	Communication error with the I/O peripheral device
EE0109	TimeOut POL965_1	Communication error with the I/O peripheral device
EE0110	TimeOut POL98U_3	Communication error with the I/O peripheral device
EE0130:	Demand Limit (AI mA)	Electrical connection error on Demand Limit connection or disconnected cable and function enabled (4-20 mA).
EE0131:	Water Reset (AI mA)	Electrical connection error on Water Reset connection or disconnected cable and function enabled (4-20 mA).
EE1001	Gas Suction Temp. 3 (BT21.1)	Electrical connection error with the temperature probe or disconnected cable.
EE1002	Gas Suction Temp. 5 (BT22.1)	Electrical connection error with the temperature probe or disconnected cable.
EE1003	Suction Press. Heating (BP3.1)	Electrical connection error with the pressure switch or disconnected cable.
EE1004	EEV 1.1 Blocked	Electronic thermostatic valve locking error.
EE1005	EEV 2.1 Blocked	Electronic thermostatic valve locking error.
ee1006	Comp. 1.1 Protection	Compressor protection active.
ee1007	Comp. 2.1 Protection	Compressor protection active.
ee1008	Comp. 3.1 Protection	Compressor protection active.
EE1011	EEV 3.1 blockage	Electronic thermostatic valve locking error.
ee1018	Source Vent. 1.1 Protection	Electrical or thermal circuit fan error.
eE1019	HTTerm	High temperature thermostat digital input alarm.
EE1022	Discharge Temp. 1.1 (BT46.1)	Electrical connection error with the temperature probe or disconnected cable.
EE1023	Discharge Temp. 2.1 (BT47.1)	Electrical connection error with the temperature probe or disconnected cable.
EE1024	Discharge Temp. 3.1 (BT47.1)	Electrical connection error with the temperature probe or disconnected cable.
EE1027	Gas Suction Temp. Probe (BT11.1)	Electrical connection error with the temperature probe or disconnected cable.
EE1028	Discharge Press. Probe (BP1.1)	Electrical connection error with the pressure switch or disconnected cable.
EE1029	Suction Press. Probe (BP2.1)	Electrical connection error with the pressure switch or disconnected cable.
ee1047	Comp. 1.1 Envelope	Error generated by the compressor envelope output or if the compressor type is not enabled.
ee1048	Comp. 2.1 Envelope	Error generated by the compressor envelope output or if the compressor type is not enabled.
ee1049	Comp. 3.1 Envelope	Error generated by the compressor envelope output or if the compressor type is not enabled.
EE1070	ECV 1.1 (User)	Electronic thermostatic valve electrical locking or mechanical failure alarm.
EE1071	ECV 2.1 (Source)	Electronic thermostatic valve electrical locking or mechanical failure alarm.
EE1072	ECV 3.1 (Source)	Electronic thermostatic valve electrical locking or mechanical failure alarm.
EE2001	Gas Suction Temp. (BT21.2)	Electrical connection error with the temperature probe or disconnected cable.
EE2002	Gas Suction Temp. (BT22.2)	Electrical connection error with the temperature probe or disconnected cable.

Code		Description
EE2003	Suction Press. Heating (BP3.2)	Electrical connection error with the temperature probe or disconnected cable.
EE2004	EEV 1.2 Blocked	Electronic thermostatic valve locking error.
EE2005	EEV 2.2 Blocked	Electronic thermostatic valve locking error.
ee2006	Comp. 1.2 Protection	Compressor protection active.
ee2007	Comp. 2.2 Protection	Compressor protection active.
ee2008	Comp. 3.2 Protection	Compressor protection active.
EE2011	EEV3 Blocked	Electronic thermostatic valve locking error.
ee2018	Source Vent. 1.2 Protection	Electrical or thermal circuit fan error.
eE2019	HTTerm	High temperature thermostat digital input alarm.
EE2022	Discharge Temp. 1.2	Electrical connection error with the temperature probe or disconnected cable.
EE2023	Discharge Temp. 2.2	Electrical connection error with the temperature probe or disconnected cable.
EE2024	Discharge Temp. 3.2	Electrical connection error with the temperature probe or disconnected cable.
EE2027	Gas Suction Temp. Probe (BT12.2)	Electrical connection error with the temperature probe or disconnected cable.
EE2028	Discharge Press. Probe (BP1.2)	Electrical connection error with the pressure switch or disconnected cable.
EE2029	Suction Press. Probe (BP2.2)	Electrical connection error with the pressure switch or disconnected cable.
ee2047	Comp. 1.2 Envelope	Error generated by the compressor envelope output or if the compressor type is not enabled.
ee2048	Comp. 2.2 Envelope	Error generated by the compressor envelope output or if the compressor type is not enabled.
ee2049	Comp. 3.2 Envelope	Error generated by the compressor envelope output or if the compressor type is not enabled.
EE2070	ECV 1.2 (User-side)	Electronic thermostatic valve electrical locking or mechanical failure alarm.
EE2071	ECV 2.2 (Source-side)	Electronic thermostatic valve electrical locking or mechanical failure alarm.
EE2072	ECV 3.2 (Source-side)	Electronic thermostatic valve electrical locking or mechanical failure alarm.
FF0001	Refrigerant Leakage	Refrigerant leakage high level alarm.
FF0002	Low Ext. Temp.	Alarm generated if the temperature is lower than parameter .
FF1001	Static Defrost 1.1	Alarm generated if static defrost is activated.
FF1005	Min Overheating EEV 1.1	Minimum overheating thermostatic valve refrigerant alarm. It is activated if the valve fails to reach the minimum overheating value set by parameter P1219: SPMinSH with capacity engaged in the minimum time set by parameter P1227: MinSHDlyAlm.
FF1006	Min Overheating EEV 2.1	Minimum overheating thermostatic valve refrigerant alarm. It is activated if the valve fails to reach the minimum overheating value set by parameter P1318: SPMinSH with capacity engaged in the minimum time set by parameter P1326: MinSHDlyAlm.
FF1007	Min Overheating EEV 3.1	Minimum overheating thermostatic valve refrigerant alarm. It is activated if the valve fails to reach the minimum overheating value set by parameter P1318: SPMinSH with capacity engaged in the minimum time set by parameter P1326: MinSHDlyAlm.
FF1010	Warning LP Cool	Pre-alarm generated if the pressure in Cooling mode is lower than parameter .
FF1011	Warning LP Heat	Pre-alarm generated if the pressure in Heating mode is lower than parameter .
fF1012	Low Pressure Alarm Heat (AI)	It is generated if the low alarm bypass is not active and the suction pressure is lower than the setpoint, set by parameter P0192: Set Alarm BP H. The alarm is then generated and resets automatically when the pressure is higher than the setpoint plus a value equal to parameter P0181: 1st Alarm BP.
fF1013	High Pressure (DI)	It is generated when there is an alarm signal from the digital input.

Code		Description
FF1014	Warning High Pressure	High pressure pre-alarm.
fF1015	High Pressure Alarm (AI)	It is generated when the discharge pressure is greater than the threshold set by parameter P0190: Set Alarm AP and resets when the discharge pressure is less than the difference between the threshold and the hysteresis defined by parameter P0196: Diff.AI.AP.
FF1016	Max RC Warning	Maximum compression ratio pre-alarm.
fF1017	Min RC Alarm	It is generated when the ratio of absolute discharge pressure to absolute suction pressure is lower than P0200:Set Min RC.
fF1018	Low Pressure Alarm Cool(AI)	It is generated if the low alarm bypass is not active and the suction pressure is lower than the setpoint, set by parameter P0193: Set PreAI.BP H. The alarm is then generated and resets automatically when the pressure is higher than the setpoint plus a value equal to parameter P0181: 1st Alarm BP.
ff1019	Max RC Alarm	It is generated when the ratio of absolute discharge pressure to absolute suction pressure is higher than P0191:Set Max RC.
FF1034	Circuit Vacuum	It is generated if there is no power used and the suction pressure is lower than the threshold set by parameter P0201:Set Circ Vacuum. It resets when the suction pressure is higher than the threshold plus a constant of 0.5.
ff1046	Low Press. Limit 1.1	It is generated if there is power used and the suction pressure is lower than the threshold set by parameter P0201:Set Circ Vacuum for at least 5s.
ff1048	Low Defrost Water Temp. 1.1	Refrigerant alarm generated by the Defrost function when it is interrupted due to low water temperature, in any scheme other than 7.
FF1050	HpDisableStart	Refrigerant alarm generated by the Defrost function when it is interrupted due to low water temperature, only when in scheme 7.
FF1060:	MaxTS	Alarm generated when the compressor enters DLT and the discharge temperature exceeds parameter .
FF1061:	MinTS	Alarm generated when the compressor enters DLT and the discharge temperature is lower than parameter .
FF2001	Static Defrost 1.2	Alarm generated if static defrost is activated.
FF2005	Min Overheating EEV 1.2	Minimum overheating thermostatic valve refrigerant alarm. It is activated if the valve fails to reach the minimum overheating value set by parameter P1219: SPMInSH with capacity engaged in the minimum time set by parameter P1227: MinSHDlyAlm.
FF2006	Min Overheating EEV 2.2	Minimum overheating thermostatic valve refrigerant alarm. It is activated if the valve fails to reach the minimum overheating value set by parameter P1318: SPMInSH with capacity engaged in the minimum time set by parameter P1326: MinSHDlyAlm.
FF2007	Min Overheating EEV 3.2	Minimum overheating thermostatic valve refrigerant alarm. It is activated if the valve fails to reach the minimum overheating value set by parameter P1318: SPMInSH with capacity engaged in the minimum time set by parameter P1326: MinSHDlyAlm.
FF2010	Warning LP Cool	Pre-alarm generated if the pressure in Cooling mode is lower than parameter .
FF2011	Warning LP Heat	Pre-alarm generated if the pressure in Heating mode is lower than parameter .
fF2012	Low Pressure Alarm Heat (AI)	It is generated if the low alarm bypass is not active and the suction pressure is lower than the setpoint, set by parameter P0192: Set Alarm BP H. The alarm is then generated and resets automatically when the pressure is higher than the setpoint plus a value equal to parameter P0181: 1st Alarm BP.
fF2013	High Pressure (DI)	It is generated when there is an alarm signal from the digital input.
FF2014	Warning High Pressure	High pressure pre-alarm. It is generated when the discharge pressure is greater than the threshold set by parameter P0190: Set Alarm AP and resets when the discharge pressure is less than the difference between the threshold and the hysteresis defined by parameter P0196: Diff.AI.AP.

Code		Description
FF2016	Max RC Warning	Maximum compression ratio pre-alarm.
fF2017	Min RC Alarm	It is generated when the ratio of absolute discharge pressure to absolute suction pressure is lower than P0200:Set Min RC.
fF2018	Low Pressure Alarm Cool(AI)	It is generated if the low alarm bypass is not active and the suction pressure is lower than the setpoint, set by parameter P0193: Set PreAl.BP H. The alarm is then generated and resets automatically when the pressure is higher than the setpoint plus a value equal to parameter P0181: 1st Alarm BP.
ff2019	Max RC Alarm	It is generated when the ratio of absolute discharge pressure to absolute suction pressure is higher than P0191:Set Max RC.
FF2034	Circuit Vacuum	It is generated if there is no power used and the suction pressure is lower than the threshold set by parameter P0201:Set Circ Vacuum. It resets when the suction pressure is higher than the threshold plus a constant of 0.5.
ff2046	Low Press. Limit 1.2	It is generated if there is power used and the suction pressure is lower than the threshold set by parameter P0201:Set Circ Vacuum for at least 5s.
ff2048	DFR Low Water Temp	Refrigerant alarm generated by the Defrost function when it is interrupted due to low water temperature, in any scheme other than 7.
FF2050	DFR Low Water Temp Rec.	Refrigerant alarm generated by the Defrost function when it is interrupted due to low water temperature, only when in scheme 7.
FF2060:	MaxTS	Alarm generated when the compressor enters DLT and the discharge temperature exceeds parameter .
FF2061:	MinTS	Alarm generated when the compressor enters DLT and the discharge temperature is lower than parameter .
ii0002	User-side Water Low Press.	High level hydraulic alarm, generated by low pressure in the hydraulic system by the digital pressure switch.
ii0006	Low User-side Flow	High level hydraulic alarm from the flow switch.
ii0007	Freeze on User-side	High level hydraulic alarm generated if the lowest temperature between return and supply is lower than the threshold set by parameter P0215:Set Al.Frost.
ii0008	Anti-freeze Pumps	High level hydraulic alarm generated if the hydraulic circuit heaters are switched on and the lowest temperature between the inlet and outlet water is lower than parameter P0215:Set Al.Frost added to parameter P0218:DeltaT Antifreeze.
ii0009	Incongruous Delta-T	High level hydraulic alarm generated if the difference between the inlet and outlet temperature, on the hot side, or between the outlet and inlet temperature, on the cold side, is lower than 1 for 20s.
ii0010	Recovery freeze	High level hydraulic alarm generated if the lowest temperature between return and supply is lower than the threshold set by parameter P0228:Set Al.FrostRec.
ii0052	Freeze on Rec-side	High level hydraulic alarm from the flow switch.
ii0053	Low Recovery Flow	High level hydraulic alarm, generated by low pressure in the hydraulic system by the digital pressure switch.
ii0062:	Recovery Low Water Press.	High level hydraulic alarm, generated by low pressure in the hydraulic system by the digital pressure switch.
ii0063:	Source Low Water Flow	High level hydraulic alarm from the flow switch.
ii0107	Source Low Water Press. 1.1	High level hydraulic alarm, generated by low pressure in the hydraulic system by the digital pressure switch.
ii0120	Source Low Water Flow 1.1	High level hydraulic alarm from the flow switch.
ii0121	Source Water Freeze 1.1	High level hydraulic alarm generated if the lowest temperature between return and supply is lower than the threshold set by parameter .

## Control

---

Code		Description
il2017	Source Low Water Press. 1.2	High level hydraulic alarm, generated by low pressure in the hydraulic system by the digital pressure switch.
il2020	Source Low Water Flow 1.2	High level hydraulic alarm from the flow switch.
ii2021	Source Water Freeze 1.2	High level hydraulic alarm generated if the lowest temperature between return and supply is lower than the threshold set by parameter .

## 10. SAFETY WARNINGS FOR OPERATIONS ON UNITS CONTAINING R32

### 10.1 Area checks

Before working on systems containing flammable refrigerants, perform safety checks to reduce the risk of combustion to the minimum. Before performing any reparation operations on the cooling system, comply with the following warnings.

### 10.2 Work procedures

Operations must be performed following a controlled procedure so as to reduce the risk of flammable gases or vapours developing.

### 10.3 General work area

All the personnel in charge with maintenance operations and other operators working in the local area must be instructed and monitored as regards the nature of the intervention.

Avoid working in tight spaces. The area surrounding the working space must be cordoned off. Make sure the area is secured by monitoring the flammable material.

### 10.4 Check the presence of refrigerant

Both before and during operations, the area must be monitored with a dedicated refrigerant detector to make sure the technician is aware of the presence of potentially-flammable environments.

Make sure the leak detection equipment is suitable for use with flammable refrigerants and therefore without sparks, suitably sealed or intrinsically safe.

### 10.5 Presence of the fire extinguisher

If hot interventions are not performed on cooling equipment or connected components, suitable fire fighting equipment must be kept at hand.

Keep a dry-powder or CO<sub>2</sub> extinguisher near the loading area.

### 10.6 No ignition source

It is absolutely forbidden to use ignition sources that may lead to fire or explosion during operations on the cooling system or on pipes that contain or have contained flammable refrigerant.

All possible ignition sources, including cigarettes, must be kept sufficiently away from the installation, reparation, removal and disposal site as flammable refrigerant may be released in the surrounding area.

Before starting operations, the area surrounding the equipment must be inspected to guarantee the absence of flammables or combustion risks. "SMOKING IS FORBIDDEN" signs must be affixed.

### 10.7 Ventilated area

Before intervening on the system or performing any hot intervention, make sure to be in an outdoor or suitably ventilated area.

Ventilation must be maintained during operations. Ventilation must disperse the released refrigerant safely, preferably outdoors in the atmosphere.

### 10.8 Cooling equipment checks

Should a replacement be necessary, the new components installed must be suitable for the purpose envisaged and compliant with specifications.

Always follow the manufacturer guidelines on maintenance and assistance. In case of doubt, contact the manufacturer technical office for assistance.

The following checks must be performed on systems containing flammable refrigerants:

- the quantity of the charge must comply with the size of the room where the parts containing refrigerant are installed;
- the machine and ventilation intake function correctly and are not obstructed;
- If an indirect cooling circuit is used, the secondary circuits must be checked to verify the presence of refrigerants; the marking on the equipment remains visible and readable;
- Make sure markings and symbols are always readable; cooling pipes or components must be installed in a position that makes improbable their exposure to substances that may corrode the components containing refrigerant, unless they are manufactured with material intrinsically resistant to corrosion or suitably protected against corrosion.

### 10.9 Electrical device checks

The reparation and maintenance of electric components must include initial safety checks and component inspection procedures.

In case of a fault that compromises safety, do not perform any electrical connection to the circuit until said fault is suitably resolved.

If it is not possible to repair the fault immediately and electrical components need to remain functioning, a temporary solution must be adopted. This must be reported to the owner of the equipment so as to keep all parties informed.

Initial safety checks must include:

- that capacitor are emptied. This operation must be performed safely to avoid any sparks;
- that electrical components and wiring are not exposed during the charging, recovering or venting phases;
- That the earth conductor is continuous

### 10.10 Repairing sealed components

- During the reparation operations of sealed components, disconnect all the equipment before removing sealed casings etc. If, during operations, it is absolutely necessary for the equipment to remain connected, a leak detection device must be placed in the most critical point so as to report any potentially-dangerous situation.
- Pay particular attention to what follows to guarantee that, while intervening on electrical components, the housing is not altered in a way so as to affect the level of protection. This includes damage to cables, an excessive number of connections, terminals not compliance with the original specifications, damage to gaskets, an unsuitable installation of gaskets, etc.
- Make sure the device is installed safely.
- Check that the seals or sealing materials are not altered in such a way that they no longer impede the entry of flammable environments. Spare parts must comply with manufacturer specifications.

 Using silicone sealants may inhibit the effectiveness of a few types of leak detection equipment. It is not necessary to isolate intrinsically safe components before performing operations on them.

### 10.11 Reparation of intrinsically safe components

Do not apply permanent inductive or capacitive loads to the circuit without making sure that they do not exceed the admissible voltage and current allowed for equipment in use.

Intrinsically safe components are the only component type on which operations can be performed in a flammable atmosphere. The testing device must show a correct value. Replace components only with the parts specified by the manufacturer.

Following a leak, other parts could lead to the combustion of the refrigerant in the atmosphere.

### 10.12 Wires

Make sure wires are not subjected to wear, corrosion, excessive pressure or vibration, that there are no sharp edges and that they do not produce other negative effects on the environment. The inspection must also keep into consideration the effects of time or the continuous vibration caused e.g. by compressors or fans.

### 10.13 Detection of flammable refrigerants

Under no circumstance is it possible to use potential ignition sources to search or detect refrigerant leaks.

Do not use halide lights (or any other open flame detectors).

### 10.14 Leak detection methods

The following leak detection methods are considered acceptable for systems containing flammable refrigerants. Electric leak detectors must always be used to identify flammable refrigerants, although they do not present a suitable sensitivity level or require recalibration (detection equipment must be calibrated in an area free from refrigerants).

Check that the detector is not a possible source of ignition and that it is suitable for the refrigerant. Leak detection equipment must always be set to an LFL percentage and calibrated depending on the refrigerant used, so the correct gas percentage (25% max) must be verified.

Leak detection fluids are suitable for most refrigerants, although using detergents containing chlorine should be avoided as this substance may react with the refrigerant and corrode copper pipes.

If a leak is suspected, all open flames must be removed or switched off.

If a leak is identified that requires brazing, all the refrigerant must be recovered from the system or isolated (using interception valves) in a section of the system far away from the leak. Oxygen-Free-Nitrogen (OFN) is then purged through the system both before and during the brazing procedure.

### 10.15 Removal and evacuation

When intervening on the cooling circuit to perform repair work or any other type of work, always follow the normal procedure. However, considering the risk of flammability, we recommend following the best practices. Comply with the following procedure:

- remove the refrigerant;
- purge the circuit with inert gas;
- evacuate;
- Purge again with inert gas;
- Interrupt the circuit with interruption or brazing.

The refrigerant charge must be collected in suitable recovery tanks. To make the unit safe, flushing with Oxygen-free-Nitrogen must be performed. This procedure may have to be repeated multiple times. Do not use compressed air or oxygen for this operation.

Flushing is obtained interrupting the system vacuum with OFN and filling until the operating pressure is obtained, then releasing into the atmosphere and restoring the vacuum. This process must be repeated until there is no trace of refrigerant in the system.

When using the final OFN charge, the system must be vented to the atmospheric pressure to allow the intervention. This step is essential to perform brazing operations on the pipes.

Make sure that the vacuum pump intake is not near

ignition sources and that there is suitable ventilation.

### 10.16 Charging operations

In addition to conventional charging operations, the following requirements must be complied with:

- When using charging equipment, make sure that the various refrigerants are not contaminated. Flexible tubes or conduits must be as short as possible to reduce to the minimum the quantity of refrigerant contained.
- Tanks must be kept in a vertical position.
- Before loading the system with refrigerant, check that the cooling system is earthed.
- Label the system when fully charged (unless already labelled).
- Make sure not to fill the cooling system excessively.
- Before recharging the system, the pressure must be tested with OFN. A leak test must be performed after the charging operations but before commissioning. Before leaving the site, perform an additional leak test.

### 10.17 Dismantling

Before performing this procedure, it is essential that the technician has become familiar with the equipment and the relative details.

We recommend employing good practices for a safe recovery of the refrigerants.

Before performing the operation, take a sample of oil and refrigerant should an analysis be necessary before reusing the regenerated refrigerant. Before performing the operation, check the availability of electricity.

- Become familiar with the equipment and how it functions.
- Electrically isolate the system.

Before attempting the procedure, check that:

- The mechanical manipulation equipment is available, if necessary, to handle refrigerant tanks;
- All the personal protection equipment is available and employed correctly;
- The recovery procedure is monitored at all times by skilled personnel;
- The recovery equipment and tanks comply with suitable standards.
- If possible, pump the cooling system.
- If it is not possible to obtain a vacuum, make sure that a collector removes the refrigerant from various parts of the system.
- Before proceeding with the recovery, check that the tank is located on the scales.
- Start up the recovery machine and use it following the instructions by the manufacturer.
- Do not fill the tanks excessively. (Do not exceed 80% of the liquid volume).

- Do not exceed the tank's maximum operating pressure, not even momentarily.
- Once the tanks are filled correctly and the process is over, make sure that the tanks and equipment are immediately removed from the site and that all insulation valves on the equipment are closed.
- The refrigerant recovered must not be loaded into another cooling system unless it has been cleaned and checked.

### 10.18 Labelling

Equipment must be labelled reporting the dismantling and emptying of the refrigerant.

Labels must be dated and signed.

Make sure all the equipment is labelled and reporting the presence of flammable refrigerant.

### 10.19 Recovery

When removing the refrigerant from the system, please adopt good practices to remove all refrigerants safely in case of both assistance or decommissioning operations.

When transferring the refrigerant into the tanks, make sure only suitable tanks are used to recover the refrigerant.

Make sure enough tanks are used.

All the tanks to be used are designated for the recovered refrigerant and are labelled for that specific refrigerant (e.g. special tanks for refrigerant collection).

Tanks must be equipped with a perfectly-functioning safety valve and relative interception valves.

Empty recovery tanks are evacuated and, if possible, cooled before recovery.

Recovery equipment must be perfectly functioning with the respective instruction booklets at hand and they must be suitable to recover flammable refrigerants. A series of perfectly-functioning calibrated scales must also be available.

Flexible tubes must be equipped with leak-proof disconnection fittings in good condition. Before using the recovery machine, make sure it is in good condition, maintained and that all associated electrical components are sealed to avoid combustion in case of a refrigerant leak. Please contact the manufacturer in case of doubt.

The refrigerant recovered must be taken to the supplier in suitable recovery tanks and with the relative waste transfer note suitably filled in.

Do not mix the refrigerants in the recovery units nor in the tanks.

If it is necessary to remove compressors or compressor oils, make sure they are evacuated to an acceptable level to make sure no trace is left of the flammable refrigerant inside the lubricant. The evacuation process must be performed before taking the compressors back to the

suppliers.

The electric resistance must be used with the compressor body only to accelerate this process.

Operations to discharge the oil from the system must be performed in full safety.

## 10.20 Transport, mark and storage

- 1 Transport of equipment containing flammable refrigerants.  
Compliance with transport regulations
- 2 Marking of equipment with symbols.  
Compliance with local regulations
- 3 Disposal of equipment employing flammable refrigerants.  
Compliance with national regulations
- 4 Storage of equipment/devices.  
The equipment must be stored in compliance with the instructions provided by the manufacturer.
- 5 Storing packed (unsold) equipment.  
Packing must be performed in such a way that mechanical damage to the equipment inside it does not cause refrigerant leaks. The maximum number of elements that can be stored together is determined by local regulations.

## 11. Maintenance

### 11.1 Safety

Operate in compliance with safety regulations in force.

To carry out the operations use protection devices: gloves, goggles, hard hat, ear protection, protective knee pads.



All operations must be carried out by personnel trained on possible risks of a general nature, electrical and deriving from operating with equipment under pressure.

Only qualified personnel can operate on the unit, as required by the regulation in force.

### 11.2 General

Maintenance must be done by authorized centres or by qualified personnel.

The maintenance allows to:

- maintain the unit efficiency
- increase the life span of the equipment
- assemble information and data to understand the state of the unit efficiency and avoid possible damages

**Before checking, please verify the following:**

 the electrical power supply line should be isolated at the beginning

 the unit isolator is open, locked and equipped with the suitable warning

 make sure no voltage is present

 After turning off the power, wait at least 5 minutes before accessing to the electrical panel or any other electrical component.

 Before accessing check with a multimeter that there are no residual voltages.

### 11.3 Inspections frequency

Perform an inspection every 6 months minimum.

The frequency, however, depends on the use.

In the event of frequent use it is recommended to plan inspections at shorter intervals:

- frequent use (continuous or very intermittent use, near the operating limits, etc)
- critical use (service necessary)



Before performing any work, please read carefully:

**SAFETY WARNINGS FOR OPERATIONS ON UNITS CONTAINING R32**



Do not go up to the surface



Do not place heavy objects.

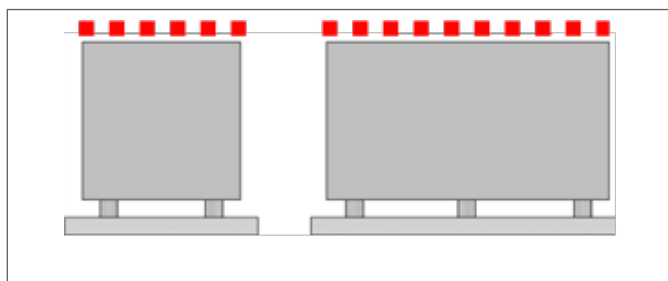

### 11.4 Unit booklet

It's advisable to create a unit booklet to take notes of the unit interventions.

In this way it will be easier to adequately note the various interventions and aid any troubleshooting.

Report on the booklet:

- date
- intervention description
- carried out measures etc.

### 11.5 Standby mode

If a long period of inactivity is foreseen:

- turn off the power
- avoid the risk of frost (empty the system or add glycol)
- Turn off the power to avoid electrical risks or damages by lightning strikes.
- With lower temperatures keep heaters turned on in of the electrical panel (option).

It's recommended that the re-start after the stopping period is performed by a qualified technician, especially after seasonal stops or seasonal switching.

When restarting, refer to what is indicated in the "start-up" section.

Schedule technical assistance in advance to avoid

misunderstandings and to guarantee that the system can be used when required.

## 11.6 Recommended periodical checks

		intervention frequency (months)		
		1	6	12
1	presence of corrosion			X
2	panel fixing			X
3	fan fixing		X	
4	coil cleaning		X	
5	water filter cleaning		X	
6	water: quality, ph, weight of glycol (%)		X	
7	check the heat exchanger efficiency	X		
8	circulating pumps			X
9	check of the fixing and the insulation of the power cables			X
10	check of the earthing cable			X
11	cleaning the electrical panel			X
12	power contactors status			X
13	terminals closing, cable insulation integrity			X
14	voltage and phase unbalancing (no load and on-load)			X
15	absorptions of the single electrical loads		X	
16	test of the compressor crankcase heaters		X	
17	Checking for leaks		X	
18	survey of the refrigeration circuit operating parameters			*
19	safety valve		X	
20	protective device test: pressure switches, thermostats, flow switches etc.			*
21	control system test: setpoint, climatic compensations, capacity stepping, water / air flow-rate variations		X	
22	control device test: alarm signalling, thermometers, probes, pressure gauges etc..		X	

 \*Refer to the local regulations. Companies and technicians performing installation, maintenance/repair, leak control and recovery operations must be CERTIFIED as set out by the local regulations.

## 11.7 System drain

The system must be drained only if necessary.

Do not drain the system periodically; this can lead to corrosion.

- 1 empty the system
- 2 empty the exchanger, use all of the shut-off valves and grub screws present
- 3 blow the exchanger with compressed air
- 4 dry the exchanger with hot air; for greater safety, fill the exchanger with glycol solution
- 5 protect the exchanger from the air
- 6 take the drain caps off the pumps

Any antifreeze liquid contained in the system should not be discharged freely as it is a pollutant. It must be collected and reused.

Before start-up, wash the system.

It's recommended that the re-start after the stopping period is performed by a qualified technician, especially after seasonal stops or seasonal switching.

When restarting, refer to what is indicated in the "start-up" section.

Schedule technical assistance in advance to avoid misunderstandings and to guarantee that the system can be used when required.

## 11.8 Compressor crankcase heater

Check:

- closing
- Operation

## 11.9 Water side exchanger

The exchanger must be able to provide the maximum thermal exchange, therefore its inner surfaces must be cleaned from dirt and incrustations.

Check the difference between the outlet water temperature and the evaporation temperature: if the difference is greater than 8°C–10°C, it is advisable to clean the exchanger.

It must be cleaned:

- with circulation opposite to the usual one
- at least 1.5 times faster than the nominal one
- with an appropriate moderately acid product (95% water + 5% phosphoric acid)
- after washing, rinse with water to remove detergent residues

## 11.10 Water filter

Check that no impurities prevent the correct passage of water.

## 11.11 Flow Switch

- check operation
- remove scale from the blade

## 11.12 Circulation pumps

Check:

- there are no leaks
- status of the bearings (anomalies are indicated by abnormal noises and vibrations)
- the terminal protection covers are closed and the cable holders are properly positioned

## 11.13 Insulations

Check the status of the insulations: if necessary, apply glue and renew the seals.

## 11.14 Pressure relief valve

The pressure relief valve must be replaced:

- if it is activated
- if there is oxidation
- based on the date of manufacture, in accordance with local regulations.

## 11.15 Structure

Check the state of the parts constituting the structure.

Treat those parts of the unit subject to oxidation, with paints act at eliminating or reducing the oxidation phenomena.

Check fastening of the unit external panelling.

Bad fastening give rise to anomalous noises and vibrations.

## 11.16 Air side exchanger

 **Accidental contact with the exchanger fins can cause cutting injuries: use protective gloves.**

The coil must give the maximum thermal exchange, therefore its surface must be cleaned from dirt and incrustations.

Clean at least every three months.

The cleaning frequency must be increased according to the build-up of dirt/dust and the environment (e.g. coastal areas with chlorides and salts or industrial areas with aggressive substances).

## Shut down periods

During periods when the unit is not operated for longer than a week, the coil must be completely cleaned following the cleaning procedure.

## Cleaning procedure

Relative to tube & fin heat exchangers, these coils tend to accumulate more dirt on the surface of the coil and less dirt inside the coil, making them easier to clean.

Follow the steps below for proper cleaning.

### Remove surface debris

Remove surface dirt, leaves, fibres, etc. with a vacuum dirt exhauster (preferably using a brush or other soft accessory rather than a metal hose), compressed air blown from the inside and/or a soft bristle brush.

 Do not bump or scrape the coil.

### Rinse

Rinse only with water.

 Do not use any chemicals to clean heat exchangers, as they may cause corrosion.

Hose off gently, preferably from the inside-out and top to bottom, running the water through every fin passage until it comes out clean. The fins are stronger than other coil fins but still need to be handled with care.

Do not use a steam cleaner as it could cause damage. Warranty claims relating to cleaning damages, particularly from steam cleaners or corrosion from chemical coil detergents, will NOT be accepted.

### Blow dry

MicroChannel heat exchangers could possibly retain more water compared to traditional tube & fin coils. It is advised to blow off or vacuum out the residual water from the coil to speed up drying and prevent pooling.

 Field applied coatings are not recommended for brazed aluminum MicroChannel heat exchangers.

## 11.17 Electric fans

Check:

- ensure that the fan and its protection grilles are fixed properly
- the fan bearings (anomalies are indicated by abnormal noise and vibrations)
- the terminal protection covers are closed and the cable holders are properly positioned

## 11.18 Refrigerant leak detector

### Option

Refer to the component manufacturer's manual for specific information.

### Maintenance

The inspection must be carried out by qualified servicing personnel.

- Check correct operation of the LEDs.
- Check correct operation of the buzzer and relay.
- Check signal transmission to the BMS / central controller, if connected.
- Calibrate the sensor or contact the manufacturer to exchange the sensor with a factory-calibrated one.

Sensors have an average life of 2 to 5 years, depending on the type, after which they must be replaced.

 Sensors must be checked after exposure to significant gas concentrations, which can reduce the duration of the sensor and/or reduce its sensitivity.

## 12. Anti-vibration mounts

### 12.1 Anti-vibration mount support

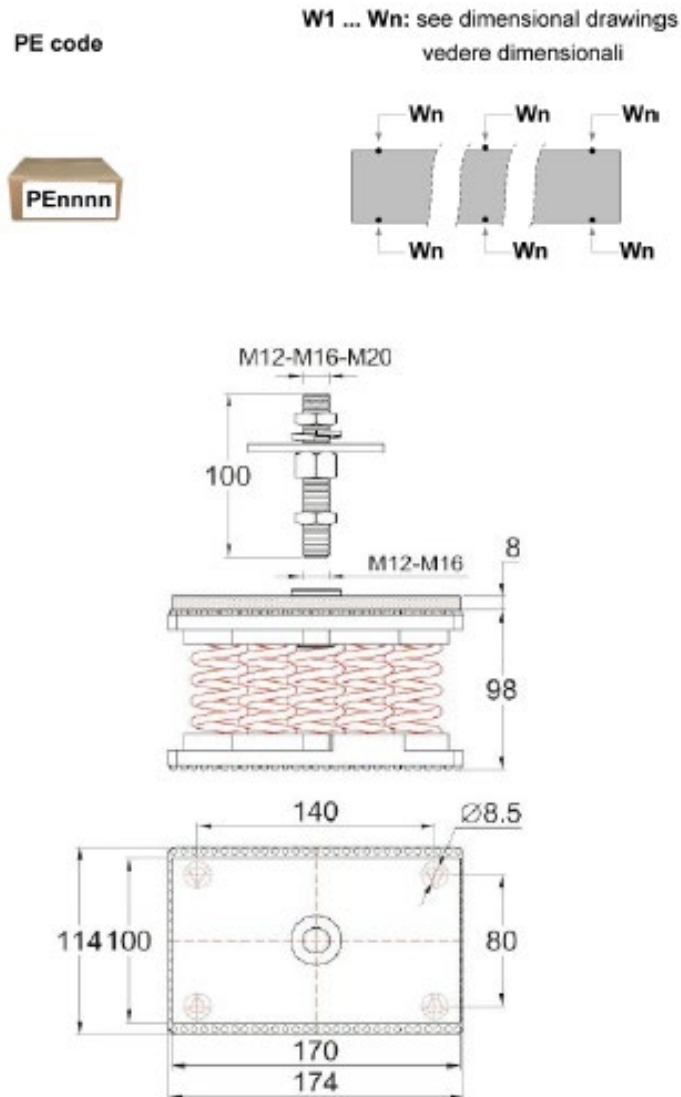

	W1	W2	W3	W4	W5	W6
PET400004	RZ608-X103	RZ608-X103	RZ608-X103	RZ608-X103		
PET400005	RX603-107P	RX603-107P	RX603-107Pr	RZ408-312Pr		
PET400006	RX603-104Pr	RX603-104P	RZ508-X201Pr	RX602-104Pr	RZ608-120Pr	RZ705Pr
PET400007	RX603-104P	RZ612-X104P	RZ408-312Pr	RZ708Pr	RX603-104Pr	RZ605-112Pr
PET400008	RX603-Z112Pr	RX507-Z220P	RZ608-X103Pr	RZ608-X103Pr	RZ412-Z220-X107P	RZ405-X302Pr
PET400014	RX403-Z312P	RX403-Z312P	RX403-Z312P	RX403-Z312P	RX403-Z312P	RX403-Z312P
PET400015	RZ408-312Pr	RX603-104P	RZ408-312Pr	RX603-104P		
PET400016	RZ612-120P	RZ612-120P	RZ612-120P	RZ612-120P		
PET400017	RX704P	RX704P	RX704P	RX704P		
PET400018	RZ408-X203-Z120P	RX507-Z220P	RZ408-X203-Z120Pr	RZ408-X203-Z120Pr	RX507-Z220P	RZ408-X203-Z120P

<b>PET400019</b>	RX703P	RX703P	RZ608-112Pr	RZ608-112Pr	RX703P	RX703P
------------------	--------	--------	-------------	-------------	--------	--------

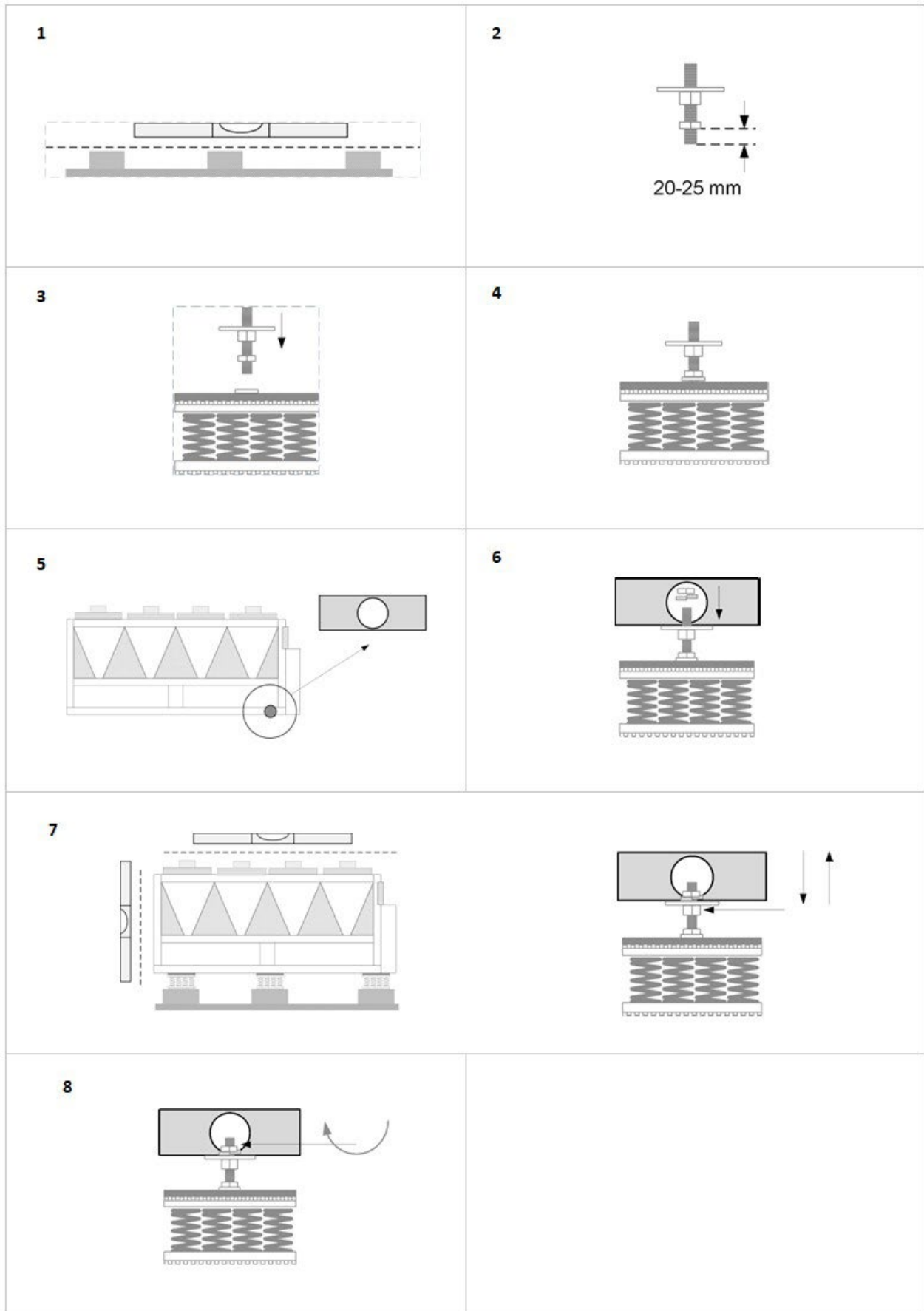

## 12.2 Anti-seismic anti-vibration mounts

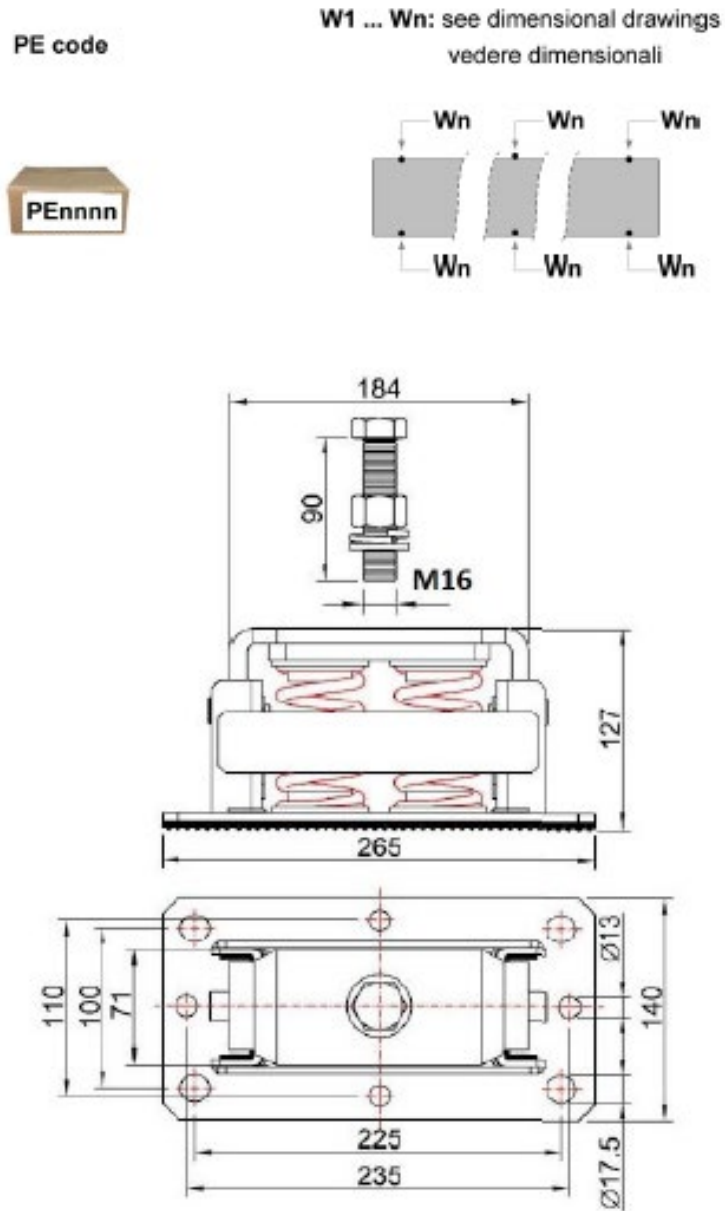

	W1	W2	W3	W4	W5	W6
<b>PET400009</b>	LaLV 510	LaLV 510	LaLV 510	LaLV 510		
<b>PET400010</b>	LaLV 247	LaLV 247	LaLV 247	LaLV 233		
<b>PET400011</b>	LaLV 55	LaLV 55	LaLV 48	LaLV 501	LaLV 51	LaLV 33
<b>PET400012</b>	LaLV 245	LaLV 248	LaLV 233	LaLV 2305	LaLV 245	LaLV 2300
<b>PET400013</b>	LaLV 245	LaLV 253	LaLV 2305	LaLV 2305	LaLV 2501	LaLV 230

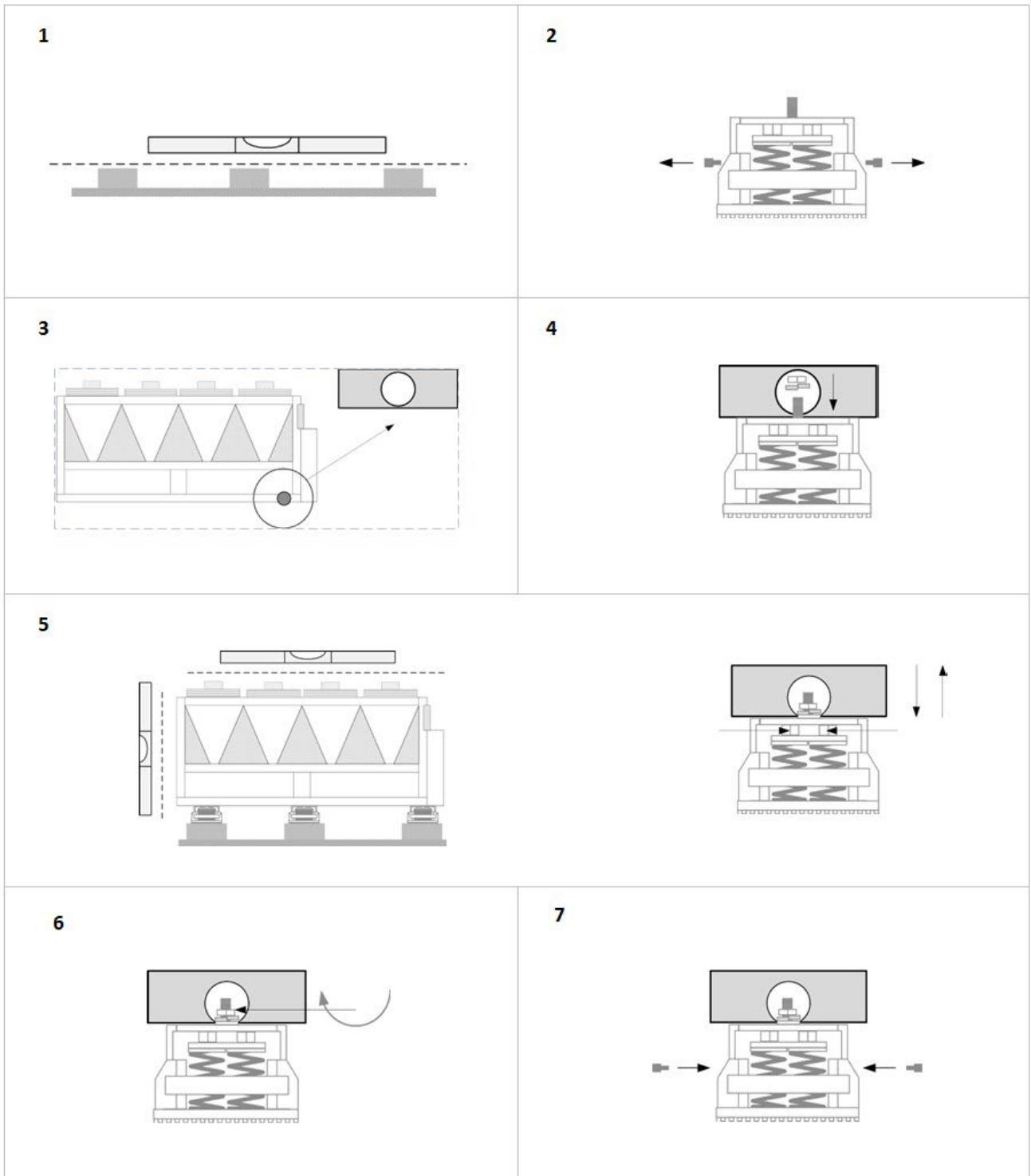

## 13. Decommissioning

### 13.1 Disconnection

 Before performing any work, carefully read: **SAFETY WARNINGS FOR OPERATIONS ON UNITS CONTAINING R32**

Avoid leak or spills into the environment.

Before disconnecting the unit, the following must be recovered, if present:

- refrigerant gas
- Anti-freeze solutions in the hydraulic circuit

Awaiting decommissioning and disposal, the unit can also be stored outdoors, as bad weather and rapid changes in temperature do not harm the environment provided that the electric, cooling and hydraulic circuits of the unit are intact and closed.

### 13.2 WEEE INFORMATION

The manufacturer is registered on the EEE National Register, in compliance with implementation of Directive 2012/19/EU and relevant national regulations on waste electrical and electronic equipment.

This Directive requires electrical and electronic equipment to be disposed of properly.

Equipment bearing the crossed-out wheellie bin mark must be disposed of separately at the end of its life cycle to prevent damage to human health and to the environment.

Electrical and electronic equipment must be disposed of together with all of its parts.

To dispose of “household” electrical and electronic equipment, the manufacturer recommends you contact an authorised dealer or an authorised ecological area.

“Professional” electrical and electronic equipment must be disposed of by authorised personnel through established waste disposal authorities around the country.

In this regard, here is the definition of household WEEE and professional WEEE:

WEEE from private households: WEEE originating from private households and WEEE which comes from commercial, industrial, institutional and other sources which, because of its nature and quantity, is similar to that from private households. Subject to the nature and quantity, where the waste from EEE was likely to have been by both a private household and users of other than private households, it will be classed as private household WEEE;

Professional WEEE: all WEEE which comes from users other than private households.

This equipment may contain:

- refrigerant gas, the entire contents of which must be recovered in suitable containers by specialised personnel with the necessary qualifications;
- lubrication oil contained in compressors and in the refrigeration circuit to be collected;
- mixtures with antifreeze in the water circuit, the contents of which are to be collected;
- mechanical and electrical parts to be separated and disposed of as authorised.

When machine components to be replaced for maintenance purposes are removed or when the entire unit reaches the end of its life and needs to be removed from the installation, waste should be separated by its nature and disposed of by authorised personnel at existing collection centres.



## 14. Residual risks

### 14.1 General

In this section the most common situations are indicated, as these cannot be controlled by the manufacturer and could be a source of risk situations for people or things.

### 14.2 Danger zone

This is an area in which only an authorised operator may work.

The danger zone is the area inside the unit which is accessible only with the deliberate removal of protections or parts thereof.

### 14.3 Handling

The handling operations, if implemented without all of the protection necessary and without due caution, may cause the drop or the tipping of the unit with the consequent damage, even serious, to persons, things or the unit itself.

Handle the unit following the instructions provided in the present manual regarding the packaging and in compliance with the local regulations in force.

Should the refrigerant leak please refer to the refrigerant "Safety sheet".

### 14.4 Installation

The incorrect installation of the unit could cause water leaks, condensate accumulation, leaking of the refrigerant, electric shock, poor operation or damage to the unit itself.

Check that the installation has been implemented by qualified technical personnel only and that the instructions contained in the present manual and the local regulations in force have been adhered to.

The installation of the unit in a place where even unfrequent leaks of flammable gas and the accumulation of this gas in the area surrounding the area occur could cause explosions or fires.

Carefully check the positioning of the unit.

The installation of the unit in a place unsuited to support its weight and/or guarantee adequate anchorage may result in consequent damage to things, people or the unit itself.

Carefully check the positioning and the anchoring of the unit.

Easy access to the unit by children, unauthorised persons or animals may be the source of accidents, some serious.

Install the unit in areas which are only accessible to authorised person and/or provide protection against intrusion into the danger zone.

### 14.5 General risks

Smell of burning, smoke or other signals of serious anomalies may indicate a situation which could cause damage to people, things or the unit itself.

Electrically isolate the unit (yellow-red isolator).

Contact the authorised service centre to identify and resolve the problem at the source of the anomaly.

Accidental contact with exchange batteries, compressors, air delivery tubes or other components may cause injuries and/or burns.

Always wear suitable clothing including protective gloves to work inside the danger zone.

Maintenance and repair operations carried out by non-qualified personnel may cause damage to persons, things or the unit itself.

Always contact the qualified assistance centre.

Failing to close the unit panels or failure to check the correct tightening of all of the panelling fixing screws may cause damage to persons, things or the unit itself.

Periodically check that all of the panels are correctly closed and fixed.

If there is a fire the temperature of the refrigerant could reach values that increase the pressure to beyond the safety valve with the consequent possible projection of the refrigerant itself or explosion of the circuit parts that remain isolated by the closure of the tap.

Do not remain in the vicinity of the safety valve and never leave the refrigerating system taps closed.

### 14.6 Electric parts

An incomplete attachment line to the electric network or with incorrectly sized cables and/or unsuitable protective devices can cause electric shocks, intoxication, damage to the unit or fires.

Carry out all of the work on the electric system referring to the electric layout and the present manual ensuring the use of a system thereto dedicated.

An incorrect fixing of the electric components cover may lead to the entry of dust, water etc inside and may consequently electric shocks, damage to the unit or fires.

Always fix the unit cover properly.

When the metallic mass of the unit is under voltage and is not correctly connected to the earthing system it may be as source of electric shock and electrocution.

Always pay particular attention to the implementation of the earthing system connections.

Contact with parts under voltage accessible inside the unit after the removal of the guards can cause electric

shocks, burns and electrocution.

Open and padlock the general isolator prior to removing the guards and signal work in progress with the appropriate sign.

Contact with parts that could be under voltage due to the start up of the unit may cause electric shocks, burns and electrocution.

When voltage is necessary for the circuit open the isolator on the attachment line of the unit itself, padlock it and display the appropriate warning sign.

### 14.7 Moving parts

Contact with the transmissions or with the fan aspiration can cause injuries.

Prior to entering the inside of the unit open the isolator situated on the connection line of the unit itself, padlock and display the appropriate warning sign.

Contact with the fans can cause injury.

Prior to removing the protective grill or the fans, open the isolator on the attachment line of the unit itself, padlock it and display the appropriate warning sign.

### 14.8 Refrigerant

The intervention of the safety valve and the consequent expulsion of the gas refrigerant may cause injuries and intoxication.

Always wear suitable clothing including protective gloves and eyeglasses for operations inside the danger zone.

Should the refrigerant leak please refer to the refrigerant "Safety sheet".

Contact between open flames or heat sources with the refrigerant or the heating of the gas circuit under pressure (e.g. during welding operations) may cause explosions or fires.

Do not place any heat source inside the danger zone.

The maintenance or repair interventions which include welding must be carried out with the system off.

### 14.9 Hydraulic parts

Defects in tubing, the attachments or the removal parts may cause a leak or water projection with the consequent damages to people, things or shortcircuit the unit.

## 15. Technical information

### Performance

#### Excellence

#### Standard acoustic configuration (ST) / Compressor soundproofing (SC)

SIZES			80.3	100.4	115.4	130.4	155.5	170.5	185.5	210.6	225.6	240.6
Cooling capacity	1	[kW]	223	267	315	364	424	472	520	574	624	676
Compressor power input	1	[kW]	64,3	80,3	93,2	107	125	139	156	171	186	204
Total power input	2	[kW]	68,9	84,8	98,9	114	133	148	165	182	198	215
Partial recovery heating capacity	3	[kW]	74,6	90,3	106	123	143	159	176	194	211	229
Total recovery heating capacity	3	[kW]	280	338	398	460	536	597	659	726	791	857
EER	1	-	3,23	3,15	3,18	3,20	3,18	3,19	3,15	3,16	3,16	3,14
Water flow-rate (User Side)	1	[l/s]	10,6	12,8	15,0	17,4	20,2	22,6	24,8	27,4	29,8	32,3
Internal exchanger pressure drop	1	[kPa]	20	27	30	37	41	38	39	46	50	41
Cooling capacity (EN14511:2022)	4	[kW]	222	267	314	364	423	472	520	573	624	675
Total power input	4	[kW]	69,4	85,5	100	115	135	149	167	184	200	218
EER (EN14511:2022)	4	-	3,20	3,12	3,15	3,17	3,15	3,16	3,11	3,12	3,12	3,10
SEER	6	-	4,70	4,67	4,78	4,75	4,92	5,00	4,96	4,94	4,96	4,90
SEPR	7	-	6,44	6,40	6,55	6,51	6,54	6,65	6,60	6,57	6,60	6,52
Cooling capacity (AHRI 550/590)	5	[kW]	221	265	312	361	420	468	514	568	622	671
Total power input (AHRI 550/590)	5	[kW]	68,7	84,5	98,5	113	133	147	165	181	197	215
COPR	5	-	3,22	3,14	3,17	3,19	3,16	3,18	3,12	3,14	3,16	3,12
IPLV	5	-	5,05	4,93	4,85	4,82	4,85	4,93	4,88	4,87	4,84	4,82

The Product is compliant with the Erp (Energy Related Products) European Directive. It includes the Commission delegated Regulation (EU) No 2016/2281, also known as Ecodesign Lot21.

Contains fluorinated greenhouse gases (GWP 675)

1. Data referring to the following conditions: Water temperature to the internal exchanger = 12/7°C. Air temperature entering the external exchanger = 35°C. Evaporator fouling factor =  $0.44 \times 10^{(-4)}$  m2 K/W
2. The Total Power Input value does not take into account the part related to the pumps and required to overcome the pressure drops for the circulation of the solution inside the exchangers.
3. Recovery exchanger water = 40/45°C
4. Data compliant to Standard EN 14511:2022 referred to the following conditions: internal exchanger water temperature = 12/7 °C. Entering external exchanger air temperature = 35°C
5. Data calculated in accordance with AHRI 550/590 under the following conditions: Water temperature to the internal exchanger = 6.7°C. Water flow-rate 0.043 l/s per kW. Air temperature entering the external exchanger = 35°C. Evaporator fouling factor =  $0.18 \times 10^{(-4)}$  m2 K/W
6. Data calculated in compliance with EN 14825:2022
7. Data calculated in accordance with Regulation (EU) 2016/2281

#### Super-silenced acoustic configuration (EN)

SIZES			80.3	100.4	115.4	130.4	155.5	170.5	185.5	210.6	225.6	240.6
Cooling capacity	1	[kW]	217	262	306	355	409	459	504	556	599	646
Compressor power input	1	[kW]	67,5	85,7	98,4	113	130	147	165	183	197	217
Total power input	2	[kW]	70,1	88,2	102	116	134	152	171	189	203	224
Partial recovery heating capacity	3	[kW]	74,0	90,4	105	122	140	158	174	192	207	224
Total recovery heating capacity	3	[kW]	276	336	392	453	522	588	649	717	772	836
EER	1	-	3,10	2,97	3,01	3,04	3,04	3,02	2,96	2,95	2,95	2,89
Water flow-rate (User Side)	1	[l/s]	10,4	12,5	14,6	16,9	19,5	21,9	24,1	26,6	28,6	30,8
Internal exchanger pressure drop	1	[kPa]	19	26	29	34	39	37	37	44	47	38
Cooling capacity (EN14511:2022)	4	[kW]	217	261	306	354	408	459	504	556	599	645
Total power input	4	[kW]	70,5	88,9	102	118	136	153	172	191	205	225
EER (EN14511:2022)	4	-	3,07	2,94	2,98	3,01	3,01	2,99	2,93	2,91	2,92	2,86
SEER	6	-	4,66	4,62	4,73	4,70	4,87	4,94	4,91	4,89	4,91	4,79
SEPR	7	-	6,38	6,33	6,48	6,44	6,48	6,57	6,53	6,50	6,53	6,46
Cooling capacity (AHRI 550/590)	5	[kW]	215	259	303	351	405	455	499	551	597	643
Total power input (AHRI 550/590)	5	[kW]	69,8	87,8	101	116	134	151	170	188	203	223
COPR	5	-	3,08	2,95	3,00	3,03	3,02	3,01	2,94	2,93	2,94	2,88
IPLV	5	-	5,01	4,86	4,79	4,75	4,80	4,78	4,87	4,85	4,83	4,80

The Product is compliant with the Erp (Energy Related Products) European Directive. It includes the Commission delegated Regulation (EU) No 2016/2281, also known as Ecodesign Lot21.

Contains fluorinated greenhouse gases (GWP 675)

1. Data referring to the following conditions: Water temperature to the internal exchanger = 12/7°C. Air temperature entering the external exchanger = 35°C. Evaporator fouling factor =  $0.44 \times 10^{(-4)}$  m2 K/W
2. The Total Power Input value does not take into account the part related to the pumps and required to overcome the pressure drops for the circulation of the solution inside the exchangers.
3. Recovery exchanger water = 40/45°C
4. Data compliant to Standard EN 14511:2022 referred to the following conditions: internal exchanger water temperature = 12/7 °C. Entering external exchanger air temperature = 35°C
5. Data calculated in accordance with AHRI 550/590 under the following conditions: Water temperature to the internal exchanger = 6.7°C. Water flow-rate 0.043 l/s per kW. Air temperature entering the external exchanger = 35°C. Evaporator fouling factor =  $0.18 \times 10^{(-4)}$  m2 K/W
6. Data calculated in compliance with EN 14825:2022
7. Data calculated in accordance with Regulation (EU) 2016/2281

## Premium

### Standard acoustic configuration (ST) / Compressor soundproofing (SC)

SIZES			90.3	110.4	130.4	145.4	170.5	185.5	210.6	225.6	240.6
Cooling capacity	1	[kW]	232	291	333	385	444	484	538	591	644
Compressor power input	1	[kW]	80,5	96,6	118	131	148	171	189	198	222
Total power input	2	[kW]	83,9	101	123	137	155	177	197	207	231
Partial recovery heating capacity	3	[kW]	81,1	101	117	134	154	170	189	205	225
Total recovery heating capacity	3	[kW]	303	377	438	502	576	636	707	768	842
EER	1	-	2,76	2,88	2,72	2,80	2,87	2,73	2,73	2,85	2,79
Water flow-rate (User Side)	1	[l/s]	11,1	13,9	15,9	18,4	21,2	23,1	25,7	28,2	30,8
Internal exchanger pressure drop	1	[kPa]	21	32	34	42	44	40	48	49	51
Cooling capacity (EN14511:2022)	4	[kW]	232	291	333	384	443	483	537	590	644
Total power input	4	[kW]	84,5	102	124	139	156	179	199	209	233
EER (EN14511:2022)	4	-	2,74	2,85	2,70	2,77	2,84	2,70	2,70	2,82	2,76
SEER	6	-	4,38	4,48	4,46	4,47	4,65	4,64	4,61	4,69	4,62
SEPR	7	-	6,00	6,13	6,11	6,13	6,18	6,17	6,13	6,23	6,15
Cooling capacity (AHRI 550/590)	5	[kW]	230	288	330	381	440	479	532	585	637
Total power input (AHRI 550/590)	5	[kW]	83,6	101	122	137	154	177	196	206	230
COPR	5	-	2,75	2,85	2,70	2,78	2,86	2,71	2,71	2,84	2,77
IPLV	5	-	4,59	4,79	4,64	4,67	4,65	4,73	4,59	4,57	4,55

The Product is compliant with the Erp (Energy Related Products) European Directive. It includes the Commission delegated Regulation (EU) No 2016/2281, also known as Ecodesign Lot21.

Contains fluorinated greenhouse gases (GWP 675)

- Data referring to the following conditions: Water temperature to the internal exchanger = 12/7°C. Air temperature entering the external exchanger = 35°C. Evaporator fouling factor =  $0.44 \times 10^{(-4)}$  m2 K/W
- The Total Power Input value does not take into account the part related to the pumps and required to overcome the pressure drops for the circulation of the solution inside the exchangers.
- Recovery exchanger water = 40/45°C
- Data compliant to Standard EN 14511:2022 referred to the following conditions: internal exchanger water temperature = 12/7 °C. Entering external exchanger air temperature = 35°C
- Data calculated in accordance with AHRI 550/590 under the following conditions: Water temperature to the internal exchanger = 6.7°C. Water flow-rate 0.043 l/s per kW. Air temperature entering the external exchanger = 35°C. Evaporator fouling factor =  $0.18 \times 10^{(-4)}$  m2 K/W
- Data calculated in compliance with EN 14825:2022
- Data calculated in accordance with Regulation (EU) 2016/2281

### Super-silenced acoustic configuration (EN)

SIZES			90.3	110.4	130.4	145.4	170.5	185.5	210.6	225.6	240.6
Cooling capacity	1	[kW]	228	283	329	374	432	474	527	580	623
Compressor power input	1	[kW]	83,3	99,6	124	135	153	178	196	205	230
Total power input	2	[kW]	85,8	103	127	139	158	183	202	211	236
Partial recovery heating capacity	3	[kW]	80,8	99,5	118	132	152	170	188	204	222
Total recovery heating capacity	3	[kW]	301	371	439	493	567	631	701	761	827
EER	1	-	2,65	2,75	2,59	2,69	2,74	2,59	2,62	2,75	2,64
Water flow-rate (User Side)	1	[l/s]	10,9	13,5	15,7	17,8	20,6	22,6	25,2	27,7	29,7
Internal exchanger pressure drop	1	[kPa]	21	30	33	39	42	39	46	47	48
Cooling capacity (EN14511:2022)	4	[kW]	227	283	329	374	432	474	527	580	622
Total power input	4	[kW]	86,3	104	128	140	159	184	203	213	239
EER (EN14511:2022)	4	-	2,63	2,73	2,57	2,67	2,71	2,57	2,59	2,72	2,61
SEER	6	-	4,34	4,44	4,42	4,45	4,62	4,61	4,59	4,63	4,59
SEPR	7	-	5,95	6,08	6,06	6,10	6,14	6,13	6,10	6,16	6,10
Cooling capacity (AHRI 550/590)	5	[kW]	226	281	326	370	429	470	522	574	616
Total power input (AHRI 550/590)	5	[kW]	85,4	103	126	138	157	182	201	210	235
COPR	5	-	2,65	2,73	2,59	2,68	2,73	2,58	2,60	2,73	2,62
IPLV	5	-	4,54	4,74	4,62	4,67	4,62	4,50	4,57	4,56	4,51

The Product is compliant with the Erp (Energy Related Products) European Directive. It includes the Commission delegated Regulation (EU) No 2016/2281, also known as Ecodesign Lot21.

Contains fluorinated greenhouse gases (GWP 675)

- Data referring to the following conditions: Water temperature to the internal exchanger = 12/7°C. Air temperature entering the external exchanger = 35°C. Evaporator fouling factor =  $0.44 \times 10^{(-4)}$  m2 K/W
- The Total Power Input value does not take into account the part related to the pumps and required to overcome the pressure drops for the circulation of the solution inside the exchangers.
- Water temperature to the recovery exchanger = 40/45°C
- Data compliant to Standard EN 14511:2022 referred to the following conditions: internal exchanger water temperature = 12/7 °C. Entering external exchanger air temperature = 35°C
- Data calculated in accordance with AHRI 550/590 under the following conditions: Water temperature to the internal exchanger = 6.7°C. Water flow-rate 0.043 l/s per kW. Air temperature entering the external exchanger = 35°C. Evaporator fouling factor =  $0.18 \times 10^{(-4)}$  m2 K/W
- Data calculated in compliance with EN 14825:2022
- Data calculated in accordance with Regulation (EU) 2016/2281

# Construction

## Excellence

SIZES		80.3	100.4	115.4	130.4	155.5	170.5	185.5	210.6	225.6	240.6
<b>Compressor</b>											
Compressor type	1	SCROLL									
Refrigerant		R-32									
No. of compressors	Nr	3	4	4	4	5	5	5	6	6	6
Nominal power (C1)	HP	40	50	50	50	50	65	80	105	105	120
Nominal Power (C2)	HP	40	50	65	80	105	105	105	105	120	120
Std capacity control steps		4	4	6	4	6	7	6	8	8	6
Oil charge (C1)	l	8	9	9	9	9	11	13	17	17	23
Oil charge (C2)	l	6	9	11	13	17	17	17	17	23	23
Refrigerant charge (C1)	kg	14	13	14	15	16	26	27	29	31	30
Refrigerant charge (C2)	kg	14	12	18	22	29	26	29	32	36	35
Refrigerant circuits	Nr	2	2	2	2	2	2	2	2	2	2
<b>Internal exchanger (evaporator)</b>											
Type of internal exchanger	2	PHE									
No. of internal exchangers	Nr	1	1	1	1	1	1	1	1	1	1
Water content	l	20	20	24	28	36	48	57	57	49	60
Minimum system water content	l	1900	1900	2200	2200	2400	2400	2400	2500	2500	2500
<b>External exchanger (condenser)</b>											
External exchanger type	3	CCM									
Number of coils	Nr	4	4	5	6	7	8	8	9	10	10
<b>Number of coils</b>											
Type of fans	4	AX									
Number of fans	Nr	4	4	5	6	7	8	8	9	10	10
Motor type	5	EC									
Standard airflow (ST/SC)	l/s	21778	21778	27222	32667	38111	43556	43556	49000	54444	54444
Standard airflow (EN)	l/s	16111	16111	20139	24167	28194	32222	32222	36250	40278	40278
<b>Connections</b>											
Water fittings		4"	4"	4"	4"	5"	5"	5"	5"	5"	5"
<b>Power supply</b>											
Power supply		400/3~/50									
<b>Electrical data</b>											
F.L.A. - Total	A	158,2	191,0	220,8	250,6	298,3	328,1	356,0	403,7	433,5	461,4
F.L.I. - Total	kW	96,3	115,4	135,1	154,7	183,6	203,2	221,6	250,5	270,1	288,5
M.I.C. - Value	6 A	492,5	432,7	555,1	584,9	632,6	662,4	690,3	738,0	767,8	795,7
M.I.C. - with soft start accessory	6 A	314,5	301,2	377,1	406,9	454,6	484,4	512,3	560,0	589,8	617,7

1. SCROLL = SCROLL compressor
2. PHE = Plate exchanger
3. CCM = Full aluminium microchannel coils
4. AX = Axial fan
5. EC = Electronically commutated permanent magnet asynchronous motor.
6. M.I.C.=Maximum unit starting current. The M.I.C. value is obtained adding the max. compressor starting current of the highest size to the power input at max. admissible conditions (F.L.A.) of the remaining electric components

Voltage unbalance between phases: max 2 %

Voltage variation: max +/- 10%

Electrical data refer to standard units; according to the installed accessories, the data can suffer some variations

# Construction

## Premium

SIZES		90.3	110.4	130.4	145.4	170.5	185.5	210.6	225.6	240.6
<b>Compressor</b>										
Compressor type	1	SCROLL								
Refrigerant		R-32								
No. of compressors	Nr	3	4	4	4	5	5	6	6	6
Nominal power (C1)	HP	25	50	65	65	50	65	105	105	120
Nominal Power (C2)	HP	65	60	65	80	120	120	105	120	120
Std capacity control steps		4	6	6	6	5	7	8	8	6
Oil charge (C1)	l	4	9	11	11	9	11	17	17	23
Oil charge (C2)	l	11	11	11	13	23	23	17	23	23
Refrigerant charge (C1)	kg	10	12	14	17	15	17	31	28	33
Refrigerant charge (C2)	kg	15	13	14	18	25	26	31	28	29
Refrigerant circuits	Nr	2	2	2	2	2	2	2	2	2
<b>Internal exchanger (evaporator)</b>										
Type of internal exchanger	2	PHE								
No. of internal exchangers	Nr	1	1	1	1	1	1	1	1	1
Water content	l	20	20	24	28	36	48	48	57	60
Minimum system water content	l	1900	2100	2200	2300	2400	2400	2500	2500	2500
<b>External exchanger (condenser)</b>										
External exchanger type	3	CCM								
Number of coils	Nr	3	4	4	5	6	6	7	8	8
<b>Number of coils</b>										
Type of fans	4	AX								
Number of fans	Nr	3	4	4	5	6	6	7	8	8
Motor type	5	EC								
Standard airflow (ST/SC)	l/s	16333	21778	21778	27222	32667	32667	38111	43556	43556
Standard airflow (EN)	l/s	13750	18333	18333	22917	27500	27500	32083	36667	36667
<b>Connections</b>										
Water fittings		4"	4"	4	4"	5"	5"	5"	5"	5"
<b>Power supply</b>										
Power supply		400/3~/50								
<b>Electrical data</b>										
F.L.A. - Total	A	171,1	209,7	246,7	276,5	324,2	352,1	399,9	429,7	457,5
F.L.I. - Total	kW	105,0	128,2	152,2	171,9	200,7	219,1	248,0	267,6	286,0
M.I.C. - Value	6 A	505,4	544,0	581,0	610,8	658,6	686,4	734,2	764,0	791,8
M.I.C. - With soft start accessory	6 A	327,4	366,0	403,0	432,8	480,6	508,4	556,2	586,0	613,8

1. SCROLL = SCROLL compressor
2. PHE = Plate exchanger
3. CCM = Full aluminium microchannel coils
4. AX = Axial fan
5. EC = Electronically commutated permanent magnet asynchronous motor.
6. M.I.C.=Maximum unit starting current. The M.I.C. value is obtained adding the max. compressor starting current of the highest size to the power input at max. admissible conditions (F.L.A.) of the remaining electric components

Voltage unbalance between phases: max 2 %

Voltage variation: max +/- 10%

Electrical data refer to standard units; according to the installed accessories, the data can suffer some variations

## Sound levels Excellence

### Standard acoustic configuration (ST)

SIZES	Sound Power Level - Octave Bands (Hz)								Sound pressure level	Sound power level
	63	125	250	500	1000	2000	4000	8000	dB(A)	dB(A)
<b>80.3</b>	73	74	80	85	86	85	77	67	71	90
<b>100.4</b>	75	76	83	86	86	86	79	70	72	91
<b>115.4</b>	75	76	83	87	87	87	79	70	72	92
<b>130.4</b>	76	77	84	88	89	88	80	70	73	93
<b>155.5</b>	74	75	80	88	90	90	82	70	74	94
<b>170.5</b>	75	75	80	88	91	90	82	70	74	95
<b>185.5</b>	75	75	81	89	91	91	82	70	75	95
<b>210.6</b>	76	76	82	90	92	92	83	71	75	96
<b>225.6</b>	76	76	81	90	92	91	83	71	75	96
<b>240.6</b>	76	77	82	90	93	92	84	71	76	97

The sound levels refer to a unit at full load, under nominal test conditions. The sound pressure level refers to 1 m from a standard unit's outer surface operating in open field. Measurements are carried out in accordance with UNI EN ISO 9614-2, in compliance with the requirements of EUROVENT 8/1 certification, which provides for a tolerance of 3 dB(A).

Data referred to the following conditions:

- Internal exchanger water temperature = 12/7°C
- Entering external exchanger air temperature = 35°C

## Sound levels

### Compressor soundproofing acoustic configuration (SC)

SIZES	(Sound Power Level - Octave Bands (Hz)								Sound pressure level	Sound power level
	63	125	250	500	1000	2000	4000	8000	dB(A)	dB(A)
<b>80.3</b>	71	72	77	83	83	82	74	64	68	87
<b>100.4</b>	72	74	79	84	84	83	76	67	69	88
<b>115.4</b>	73	74	79	85	85	84	76	67	69	89
<b>130.4</b>	74	75	80	85	86	85	77	67	70	90
<b>155.5</b>	72	73	77	85	87	85	78	66	70	90
<b>170.5</b>	73	73	77	86	88	85	79	67	71	91
<b>185.5</b>	73	73	78	86	88	86	79	67	71	91
<b>210.6</b>	73	74	79	87	89	86	79	68	71	92
<b>225.6</b>	74	74	79	87	89	87	80	67	71	92
<b>240.6</b>	74	75	79	88	90	88	80	68	72	93

The sound levels refer to a unit at full load, under nominal test conditions. The sound pressure level refers to 1 m from a standard unit's outer surface operating in open field. Measurements are carried out in accordance with UNI EN ISO 9614-2

Data referred to the following conditions:

- Internal exchanger water temperature = 40/45 °C
- Air temperature entering the external exchanger = 7/6°C.

## Sound levels

### Super-silenced acoustic configuration (EN)

SIZES	(Sound Power Level - Octave Bands (Hz								Sound pressure level	Sound power level
	63	125	250	500	1000	2000	4000	8000	(dB(A	(dB(A
<b>80.3</b>	58	71	75	79	79	80	71	64	65	84
<b>100.4</b>	59	72	77	80	78	80	72	66	65	84
<b>115.4</b>	60	73	78	81	81	82	73	66	66	86
<b>130.4</b>	59	72	77	81	81	82	73	65	66	86
<b>155.5</b>	59	71	76	80	82	81	73	65	66	86
<b>170.5</b>	60	71	77	81	83	82	74	66	67	87
<b>185.5</b>	60	72	77	82	84	83	75	66	68	88
<b>210.6</b>	61	72	78	82	84	83	75	66	67	88
<b>225.6</b>	61	72	77	82	84	84	75	66	67	88
<b>240.6</b>	61	72	78	83	85	84	76	66	68	89

The sound levels refer to a unit at full load, under nominal test conditions. The sound pressure level refers to 1 m from a standard unit's outer surface operating in open field. Measurements are carried out in accordance with UNI EN ISO 9614-2, in compliance with the requirements of EUROVENT 8/1 certification, which provides for a tolerance of 3 dB(A).

Data referred to the following conditions:

- Internal exchanger water temperature = 12/7°C
- Entering external exchanger air temperature = 35°C

## Sound levels

### Premium

#### Standard acoustic configuration (ST)

SIZES	(Sound Power Level - Octave Bands (Hz)								Sound pressure level	Sound power level
	63	125	250	500	1000	2000	4000	8000	(dB(A)	(dB(A)
<b>90.3</b>	73	74	81	84	86	85	78	68	71	90
<b>110.4</b>	74	76	83	86	87	86	79	69	72	91
<b>130.4</b>	74	75	83	86	87	87	79	69	73	92
<b>145.5</b>	75	76	83	87	89	88	80	70	73	93
<b>170.5</b>	73	74	80	87	90	90	81	70	74	94
<b>185.5</b>	73	74	80	87	90	90	81	69	74	94
<b>210.6</b>	74	75	81	88	91	91	82	71	75	95
<b>225.6</b>	75	76	82	89	92	92	83	71	76	96
<b>240.6</b>	75	75	81	89	92	91	83	71	76	96

The sound levels refer to a unit at full load, under nominal test conditions. The sound pressure level refers to 1 m from a standard unit's outer surface operating in open field. Measurements are carried out in accordance with UNI EN ISO 9614-2, in compliance with the requirements of EUROVENT 8/1 certification, which provides for a tolerance of 3 dB(A).

Data referred to the following conditions:

- Internal exchanger water temperature = 12/7°C
- Entering external exchanger air temperature = 35°C

## Sound levels

### Premium

#### Compressor soundproofing acoustic configuration (SC)

SIZES	(Sound Power Level - Octave Bands (Hz)								Sound pressure level	Sound power level
	63	125	250	500	1000	2000	4000	8000	(dB(A)	(dB(A)
<b>90.3</b>	71	72	77	83	83	82	74	65	68	87
<b>110.4</b>	72	74	79	84	84	83	76	66	69	88
<b>130.4</b>	72	73	79	84	85	84	76	66	70	89
<b>145.5</b>	72	73	79	84	85	84	76	66	69	89
<b>170.5</b>	71	72	77	85	87	85	77	66	70	90
<b>185.5</b>	71	72	77	85	87	85	78	66	70	90
<b>210.6</b>	72	73	78	86	88	86	78	67	71	91
<b>225.6</b>	73	74	79	87	89	87	79	68	72	92
<b>240.6</b>	73	74	79	86	89	87	79	67	72	92

The sound levels refer to a unit at full load, under nominal test conditions. The sound pressure level refers to 1 m from a standard unit's outer surface operating in open field. Measurements are taken in accordance with Standard UNI EN ISO 9614-2

Data referred to the following conditions:

- Internal exchanger water temperature = 40/45 °C
- Air temperature entering the external exchanger = 7/6°C.

## Sound levels

### Premium

#### Super-silenced acoustic configuration (EN)

SIZES	(Sound Power Level - Octave Bands (Hz								Sound pressure level	Sound power level
	63	125	250	500	1000	2000	4000	8000	(dB(A	(dB(A
<b>90.3</b>	60	73	76	80	79	80	71	63	65	84
<b>110.4</b>	63	76	79	82	81	82	73	65	67	86
<b>130.4</b>	62	74	78	82	81	82	73	65	67	86
<b>145.5</b>	63	75	79	83	83	83	73	65	67	87
<b>170.5</b>	62	74	77	82	83	82	74	65	67	87
<b>185.5</b>	63	75	78	83	84	83	75	65	68	88
<b>210.6</b>	64	76	79	84	85	84	76	67	69	89
<b>225.6</b>	64	76	79	84	85	84	76	66	69	89
<b>240.6</b>	63	76	78	84	85	84	76	66	69	89

The sound levels refer to a unit at full load, under nominal test conditions. The sound pressure level refers to 1 m from a standard unit's outer surface operating in open field. Measurements are carried out in accordance with UNI EN ISO 9614-2, in compliance with the requirements of EUROVENT 8/1 certification, which provides for a tolerance of 3 dB(A).

Data referred to the following conditions:

- Internal exchanger water temperature = 12/7°C
- Entering external exchanger air temperature = 35°C

## Fields of application

### Excellence ST/SC

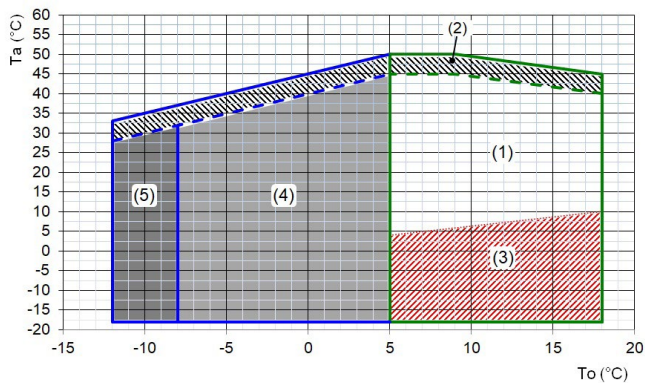

Ta (°C) = air temperature entering the external exchanger (D.B.)  
To (°C) = outlet water temperature from the internal exchanger

1. Standard unit operating range at full load
2. Unit operating range with automatic partialization of the compressor capacity
3. Standard unit operating range with automatic modulation of the airflow
4. Unit operating range in "B- Low water temperature" configuration
5. Extended operating range (Very low water temperature option available on request)

### Excellence EN

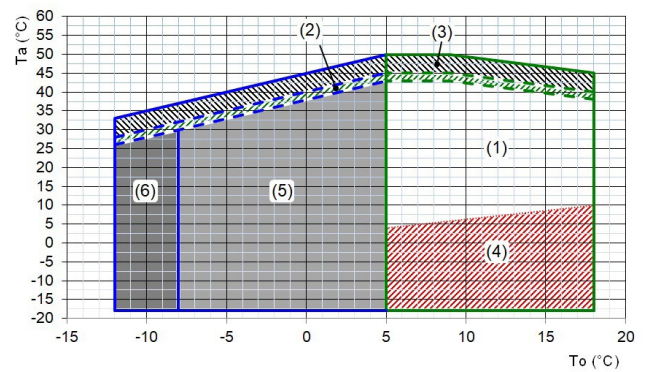

Ta (°C) = air temperature entering the external exchanger (D.B.)  
To (°C) = outlet water temperature from the internal exchanger

1. Standard unit operating range at full load
2. Extension of the operating range with automatic increase of the airflow. Within these ranges the sound levels are the same as for the 'Compressor soundproofing (SC)' acoustic configuration
3. Unit operating range with automatic partialization of the compressor capacity
4. Standard unit operating range with automatic modulation of the airflow
5. Unit operating range in "B- Low water temperature" configuration
6. Extended operating range (Very low water temperature option available on request)

### Premium ST/SC

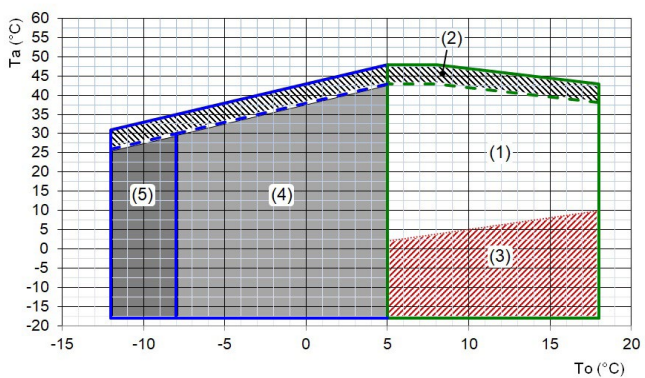

Ta (°C) = air temperature entering the external exchanger (D.B.)  
To (°C) = outlet water temperature from the internal exchanger

1. Standard unit operating range at full load
2. Unit operating range with automatic partialization of the compressor capacity
3. Standard unit operating range with automatic modulation of the airflow
4. Unit operating range in "B- Low water temperature" configuration
5. Extended operating range (Very low water temperature option available on request)

### Premium EN

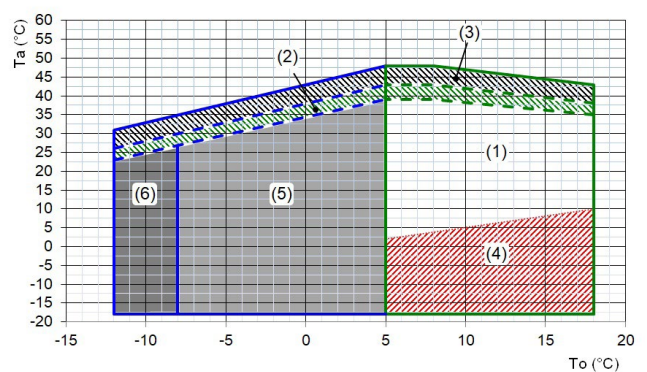

Ta (°C) = air temperature entering the external exchanger (D.B.)  
To (°C) = outlet water temperature from the internal exchanger

1. Standard unit operating range at full load
2. Extension of the operating range with automatic increase of the airflow. Within these ranges the sound levels are the same as for the 'Compressor soundproofing (SC)' acoustic configuration
3. Unit operating range with automatic partialization of the compressor capacity
4. Standard unit operating range with automatic modulation of the airflow
5. Unit operating range in "B- Low water temperature" configuration
6. Extended operating range (Very low water temperature option available on request)

### Correction factors when using ethylene glycol

ETHYLENE GLYCOL WEIGHT %		5%	10%	15%	20%	25%	30%	35%	40%	45%	50%
Freezing temperature	°C	-2	-3,9	-6,5	-8,9	-11,8	-15,6	-19,0	-23,4	-27,8	-32,7
Safety temperature	°C	3	1	-1	-4	-6	-10	-14	-19	-23,8	-29,4
Cooling capacity factor	Nr	0,997	0,994	0,990	0,986	0,981	0,976	0,970	0,964	0,957	0,950
Compressor power input factor	Nr	0,999	0,999	0,998	0,997	0,996	0,996	0,995	0,994	0,993	0,993
Internal exchanger pressure drop factor	Nr	1,016	1,035	1,056	1,080	1,106	1,135	1,166	1,200	1,236	1,275

### Correction factors when using propylene glycol

PROPYLENE GLYCOL WEIGHT %		5%	10%	15%	20%	25%	30%	35%	40%	45%	50%
Freezing temperature	°C	-2	-3,9	-6,5	-8,9	-11,8	-15,6	-19,0	-23,4	-27,8	-32,7
Safety temperature	°C	3	1	-1	-4	-6	-10	-14	-19	-23,8	-29,4
Cooling capacity factor	Nr	0,995	0,990	0,983	0,976	0,968	0,960	0,950	0,939	0,928	0,916
Compressor power input factor	Nr	0,999	0,997	0,995	0,993	0,991	0,988	0,986	0,983	0,980	0,977
Internal exchanger pressure drop factor	Nr	1,027	1,058	1,093	1,133	1,176	1,224	1,276	1,332	1,393	1,457

### Scaling correction factors

#### SCAMBIATORE INTERNO (EVAPORATORE)

M2 °C/W	F1	FK1
0,44 x 10 (-4)	1,0	1,0
0,88 x 10 (-4)	0,97	0,99
1,76 x 10 (-4)	0,94	0,98

F1 = Cooling capacity correction factor

FK1 = Power absorbed by the compressors correction factor

### Exchanger operating range

#### SCAMBIATORE INTERNO

		DPR	DPW
Plate exchanger	PED (CE)	4500	1000
Shell-and-tube heat exchanger	PED (CE)	4500	1000

DPr = Maximum operating pressure on refrigerant side in kPa

DPw = Pressione max. di funzionamento lato acqua in kPa

### Protections and controls settings

		APRE	CHIUDE	VALORE
High pressure switch	kPa	4050		-
Antifreeze protection	°C	4	5,5	-
HP pressure relief valve	kPa	-	-	4500
LP pressure relief valve	kPa	-	-	3000
Max no. of compressor start-ups per hour	n°	-	-	10
Discharge safety thermostat	°C	-	-	150

## Dimensional drawings

SIZES 80.3 - 100.4 EXC / 90.3 TO 130.4 PRM

DAAT40001\_00  
DATA/DATE 10/03/2020

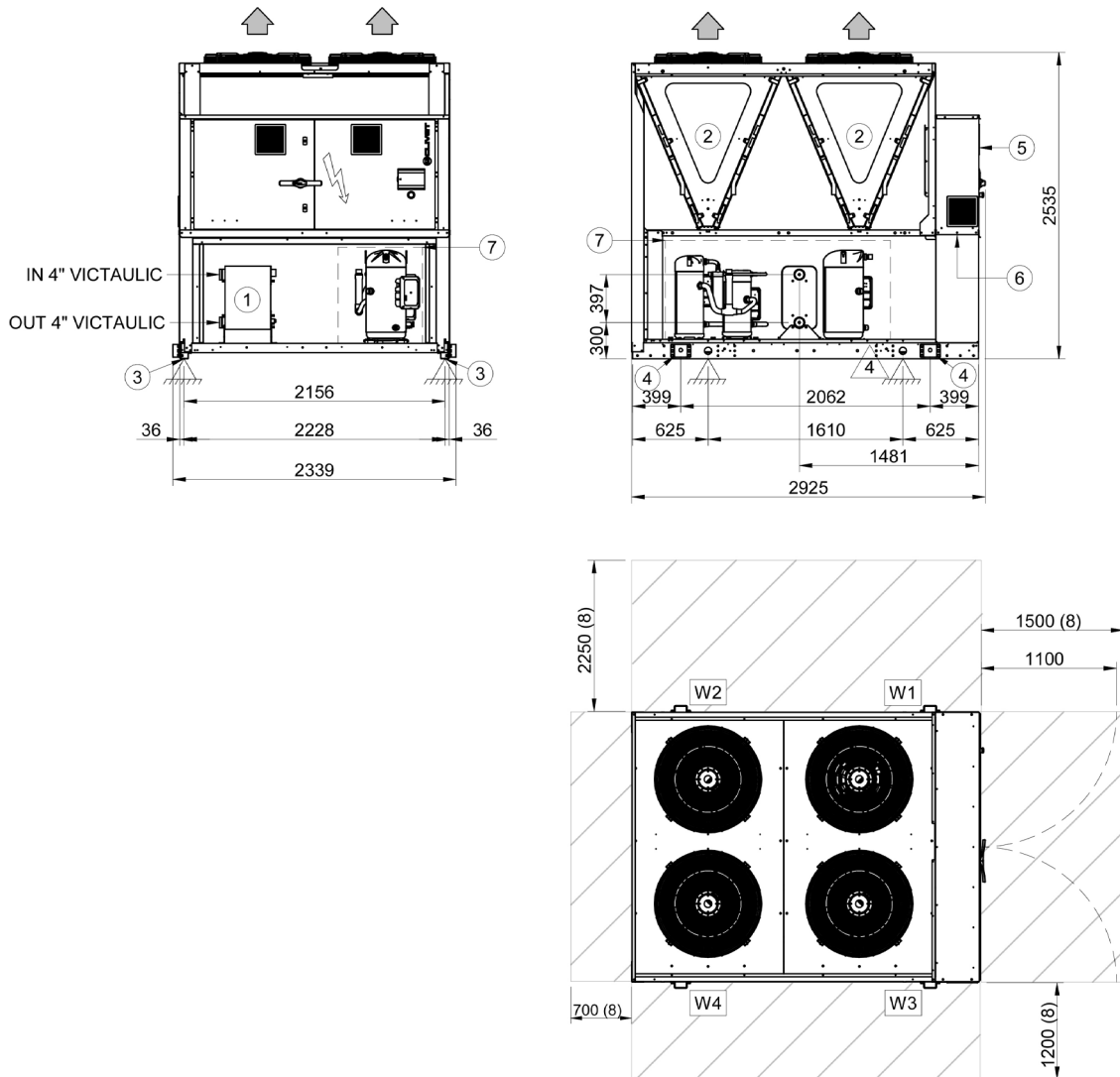

1. Internal exchanger (Evaporator)
2. External exchanger (condenser)
3. Unit fixing holes
4. Lifting bracket (removed)
5. Electrical panel
6. Power input
7. Sound proof enclosure (optional)
8. Clearance access recommended

SIZES		80.3 EXC		100.4 EXC		90.3 PRM		110.4 PRM		130.4 PRM	
		ST	SC/EN	ST	SC/EN	ST	SC/EN	ST	SC/EN	ST	SC/EN
Length	mm	2925	2925	2925	2925	2925	2925	2925	2925	2925	2925
Depth	mm	2228	2228	2228	2228	2228	2228	2228	2228	2228	2228
Height	mm	2535	2535	2535	2535	2535	2535	2535	2535	2535	2535
W1 Support point	kg	450	509	463	522	485	544	504	563	526	585
W2 Support point	kg	432	494	431	493	406	468	455	517	505	567
W3 Support point	kg	413	446	423	456	446	479	450	483	458	491
W4 Support point	kg	395	431	391	427	367	403	401	437	437	473
Operation weight	kg	1689	1879	1708	1898	1703	1893	1810	2000	1926	2116
Operating weight	kg	1628	1818	1647	1837	1642	1832	1749	1939	1868	2058

The presence of optional accessories may result in significant variation of the weights indicated

**SIZES 115.4 - 130.4 EXC / 145.4 PRM**

DAAT40002\_00  
DATA/DATE 29/11/2020

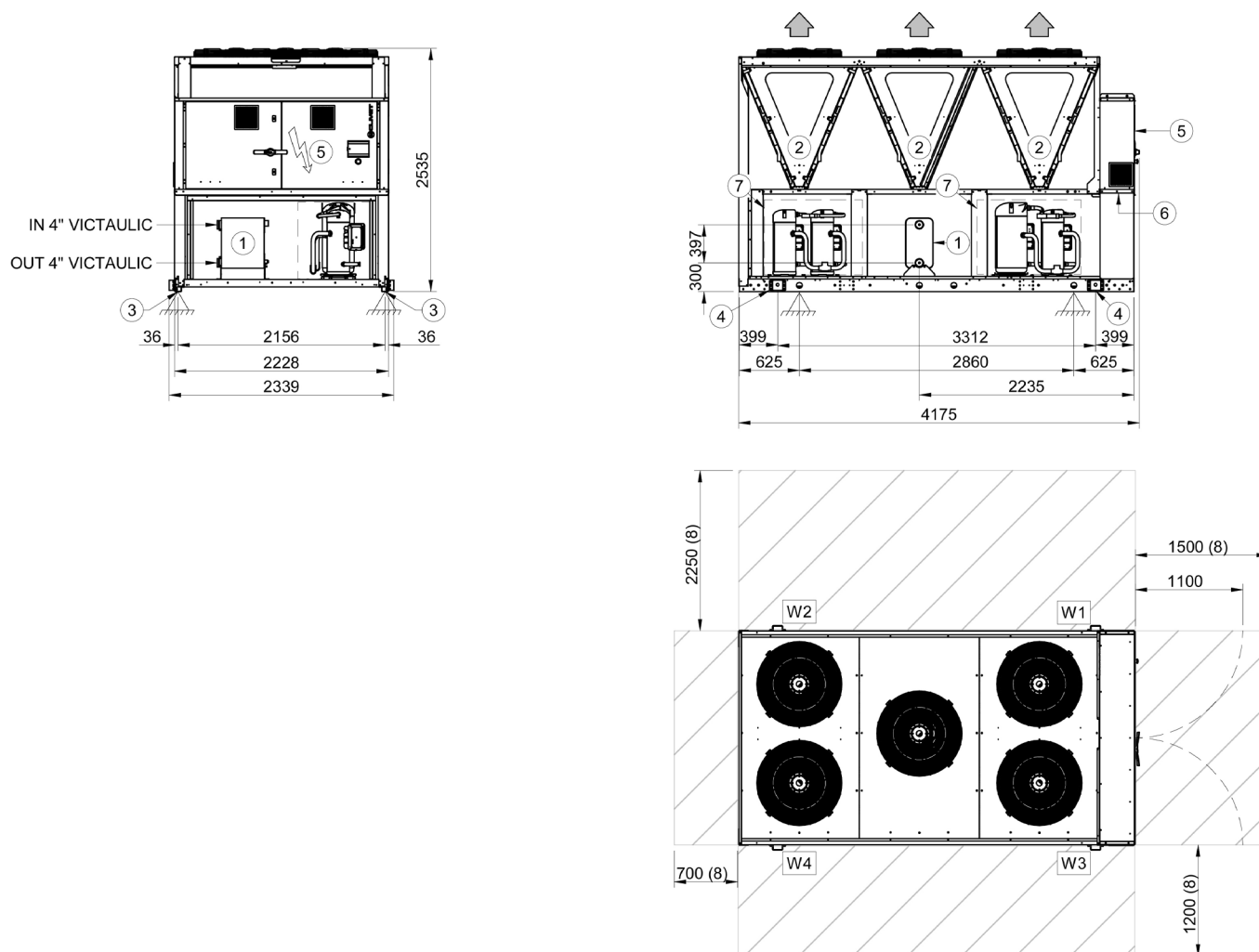

- 1. Internal exchanger (Evaporator)
- 2. External exchanger (condenser)
- 3. Unit fixing holes
- 4. Lifting bracket (removed)
- 5. Electrical panel
- 6. Power input
- 7. Sound proof enclosure (optional)
- 8. Clearance access recommended

SIZES		115.4 EXC		130.4 EXC		145.4 PRM	
		ST	SC/EN	ST	SC/EN	ST	SC/EN
Length	mm	4175	4175	4175	4175	4175	4175
Depth	mm	2228	2228	2228	2228	2228	2228
Height	mm	2535	2535	2535	2535	2535	2535
W1 Support point	kg	588	647	640	700	654	713
W2 Support point	kg	542	607	577	642	619	684
W3 Support point	kg	531	566	570	605	569	604
W4 Support point	kg	485	525	507	547	534	575
Operation weight	kg	2145	2345	2294	2494	2376	2576
Operating weight	kg	2115	2315	2254	2454	2336	2536

The presence of optional accessories may result in significant variation of the weights indicated

**SIZES 170.5 - 180.5 PRM**

DAAT40003\_00  
DATA/DATE 19/03/2020

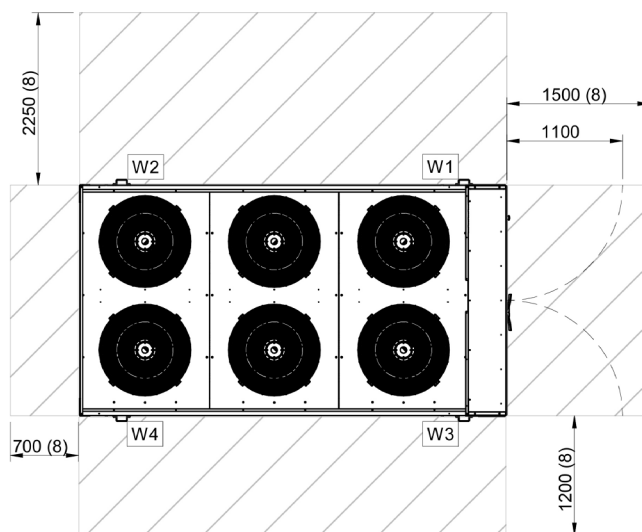
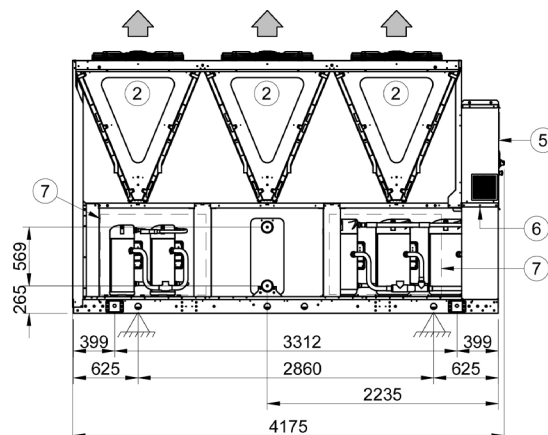
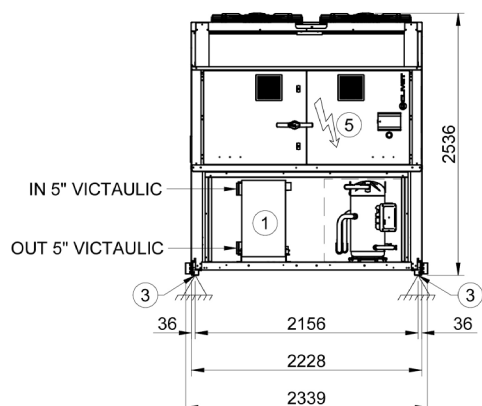

- 1. Internal exchanger (Evaporator)
- 2. External exchanger (condenser)
- 3. Unit fixing holes
- 4. Lifting bracket (removed)
- 5. Electrical panel
- 6. Power input
- 7. Sound proof enclosure (optional)
- 8. Clearance access recommended

SIZES		170.5 PRM		185.5 PRM	
		ST	SC/EN	ST	SC/EN
Length	mm	4175	4175	4175	4175
Depth	mm	2228	2228	2228	2228
Height	mm	2535	2535	2535	2535
W1 Support point	kg	741	806	777	841
W2 Support point	kg	632	693	697	757
W3 Support point	kg	649	689	672	712
W4 Support point	kg	540	576	592	628
Operation weight	kg	2563	2763	2738	2938
Operating weight	kg	2513	2713	2678	2878

The presence of optional accessories may result in significant variation of the weights indicated

**SIZES 155.5 TO 185.5 EXC / 210.6 TO 240.6 PRM**

DAAT40006\_00  
DATA/DATE 08/07/2020

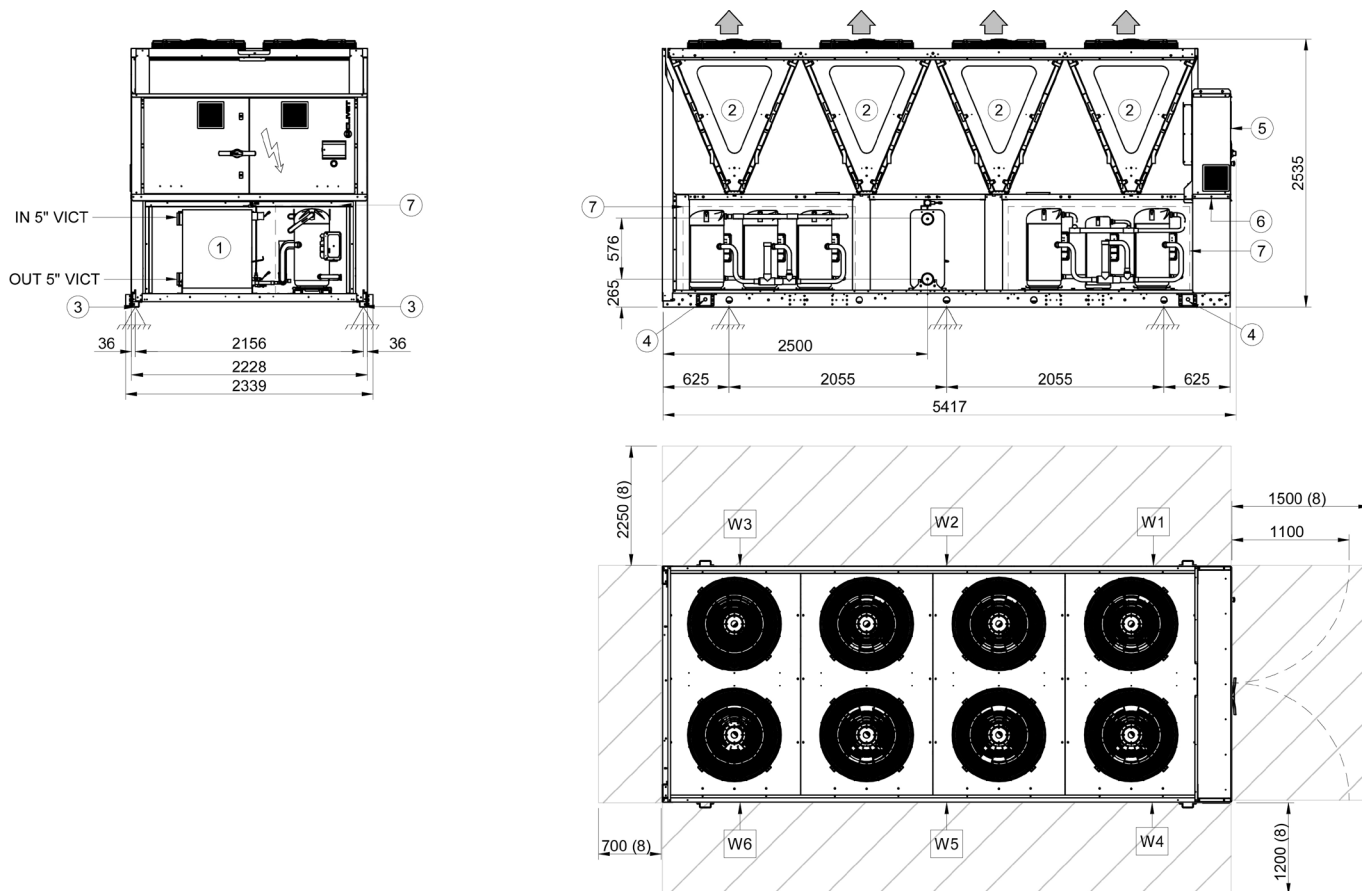

- 1. Internal exchanger (Evaporator)
- 2. External exchanger (condenser)
- 3. Unit fixing holes
- 4. Lifting bracket (removed)
- 5. Electrical panel
- 6. Power input
- 7. Sound proof enclosure (optional)
- 8. Clearance access recommended

SIZES		155.5 EXC		170.5 EXC		185.5 EXC		210.6 PRM		225.6 PRM		240.6 PRM	
		ST	SC/EN	ST	SC/EN	ST	SC/EN	ST	SC/EN	ST	SC/EN	ST	SC/EN
Length	mm	5417	5417	5417	5417	5417	5417	5417	5417	5417	5417	5417	5417
Depth	mm	2228	2228	2228	2228	2228	2228	2228	2228	2228	2228	2228	2228
Height	mm	2535	2535	2535	2535	2535	2535	2535	2535	2535	2535	2535	2535
W1 Support point	kg	601	651	599	649	603	653	606	611	660	710	659	708
W2 Support point	kg	606	658	645	697	677	729	663	670	725	780	748	803
W3 Support point	kg	345	395	415	465	481	531	541	546	545	608	608	672
W4 Support point	kg	428	443	427	442	432	448	437	442	458	474	459	474
W5 Support point	kg	519	535	561	577	593	609	553	561	606	623	621	638
W6 Support point	kg	281	297	305	321	328	344	341	346	348	368	370	389
Operation weight	kg	2779	2979	2952	3152	3114	3314	3141	3176	3343	3563	3464	3684
Operating weight	kg	2729	2929	2892	3092	3044	3244	3085	3120	3277	3497	3394	3614

The presence of optional accessories may result in significant variation of the weights indicated

**SIZES 210.6 TO 240.6 EXC**

DAAT40004\_00  
DATA/DATE 19/05/2020

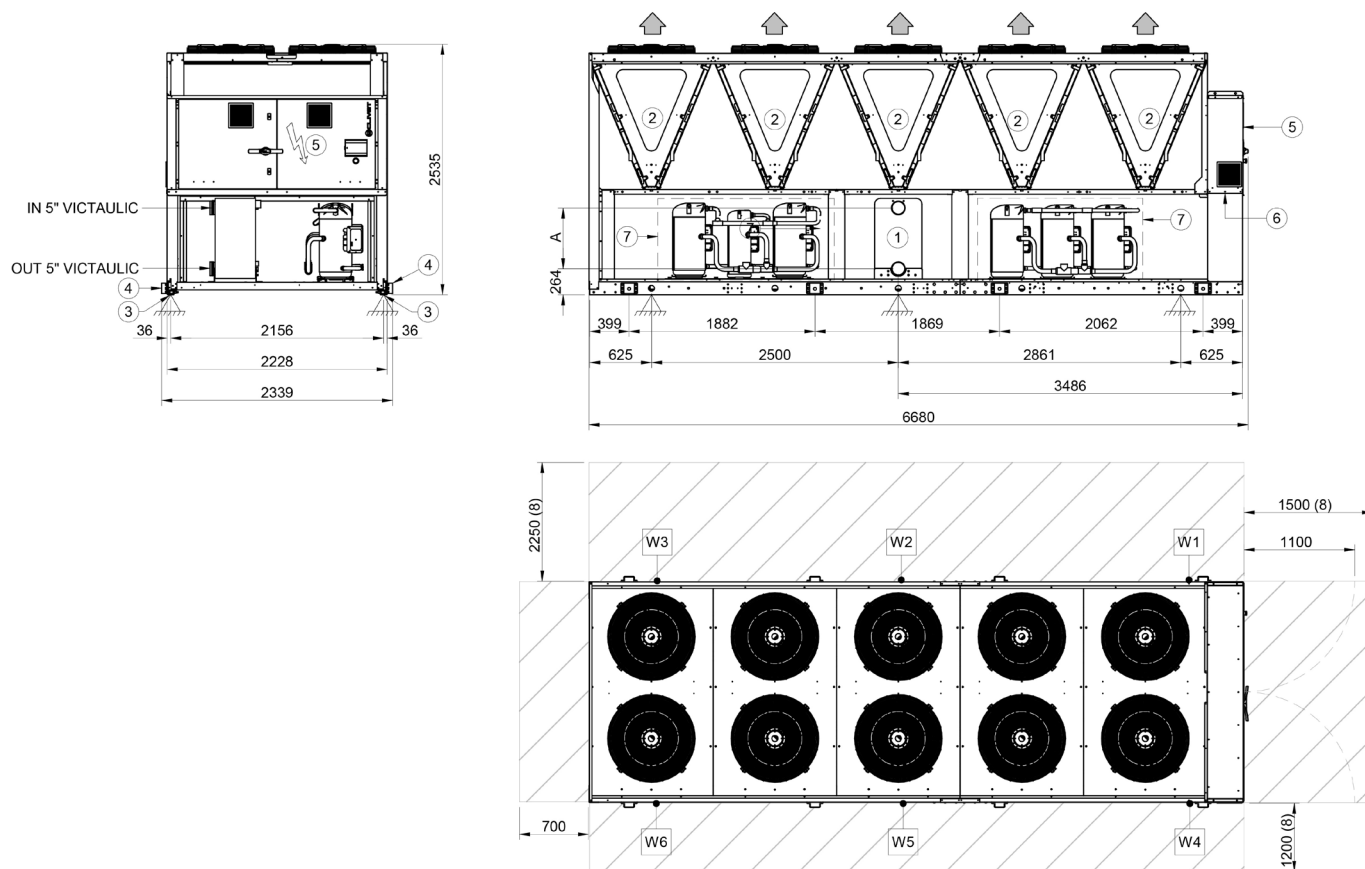

- 1. Internal exchanger (Evaporator)
- 2. External exchanger (condenser)
- 3. Unit fixing holes
- 4. Lifting bracket (removed)
- 5. Electrical panel
- 6. Power input
- 7. Sound proof enclosure (optional)
- 8. Clearance access recommended

SIZES		210.6 EXC		225.6 EXC		240.6 EXC	
		ST	SC/EN	ST	SC/EN	ST	SC/EN
Length	mm	6680	6680	6680	6680	6680	6680
Depth	mm	2228	2228	2228	2228	2228	2228
Height	mm	2535	2535	2535	2535	2535	2535
W1 Support point	kg	562	598	598	634	594	630
W2 Support point	kg	1019	1119	1060	1161	1115	1216
W3 Support point	kg	438	479	430	471	474	515
W4 Support point	kg	451	463	462	475	461	474
W5 Support point	kg	791	826	844	880	894	930
W6 Support point	kg	310	325	308	323	322	336
Operation weight	kg	3570	3810	3703	3943	3860	4100
Operating weight	kg	3500	3740	3633	3873	3780	4020

The presence of optional accessories may result in significant variation of the weights indicated







FOR OVER 35 YEARS WE HAVE BEEN  
OFFERING SOLUTIONS FOR SUSTAINABLE  
COMFORT AND THE WELL-BEING OF PEOPLE  
AND THE ENVIRONMENT

Info & Contacts: [www.clivet.com](http://www.clivet.com)

