

## MONOSplit

### STELVIO 27M - 35M

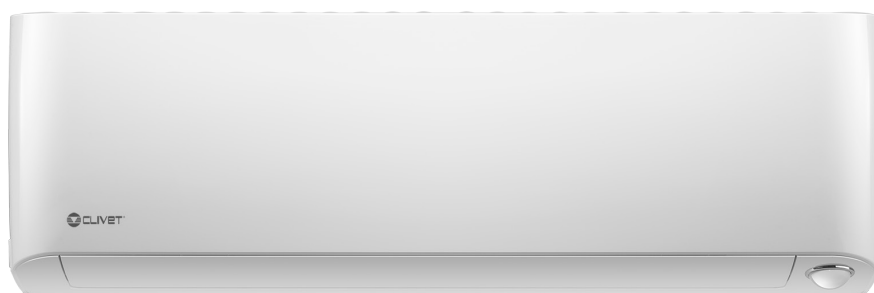

---

## Table of Contents

Page

<b>1. Specifications .....</b>	<b>3</b>
1. Model Reference	
2. General Specifications	
3. Dimensional Drawings	
4. Electrical Wiring Diagrams	
5. Refrigerant Cycle Diagrams	
6. Capacity Tables	
7. Noise Criterion Curves	
8. Electrical Characteristics	
<b>2. Product Features .....</b>	<b>18</b>
1. Operation Modes and Functions	
2. Remote Controller Functions	
<b>3. Installation .....</b>	<b>30</b>
1. Installation Overview	
2. Location Selection	
3. Indoor Unit Installation	
4. Outdoor Unit Installation	
5. Refrigerant Pipe Installation	
6. Vacuum Drying and Leakage Checking	
7. Additional Refrigerant Charge	
8. Electrical and Gas Leak Checks	
9. Test Operation	

---

# Specifications

## Contents

1.	Model Reference.....	4
2.	General Specifications.....	5
3.	Dimensional Drawings.....	7
4.	Electrical Wiring Diagrams.....	9
5.	Refrigerant Cycle Diagrams.....	11
6.	Capacity Tables.....	12
7.	Noise Criterion Curves.....	15
8.	Electrical Characteristics.....	17

---

## 1. Model Reference

Refer to the following table to determine the specific indoor and outdoor unit model number of your purchased equipment.

Indoor Unit Model	Outdoor Unit Model	Capacity (Btu/h)	Power Supply
IH2-Y 27M-35M	MH2-Y 27M-35M	12k	1Ph, 220-240V~, 50Hz

## 2. General Specifications

Model			IH2-Y 27M-35M
Power supply		V- Ph-Hz	220-240-1-50
Rated Power Input		W	2950
Rated Current		A	13
Compressor	Model		KSN98D64UFZ3
	Type		ROTARY
	Brand		GMCC
	Capacity	W	1930/3100
	Input	W	292/765
	Rated current(RLA)	A	2.15/4.65
	Locked rotor Amp(LRA)	A	/
	Thermal protector		/
	Thermal protector position		/
	Capacitor	uF	/
	Refrigerant oil/oil charge	ml	ESTER OIL VG74/300
Indoor fan motor	Model		ZKFP-20-8-6-7
	Input	W	50
	Output	W	20
	Capacitor	uF	/
	Speed(Hi/Mi/Lo)	r/min	1250/950/650
Indoor coil	Number of rows		4
	Tube pitch(a)x row pitch(b)	mm	21x13.37+14.5x10
	Fin spacing	mm	1.2
	Fin type (code)		Hydrophilic aluminum
	Tube outside dia.and type	mm	Φ5+Φ7,Inner groove tube
	Coil length x height x width	mm	675x84x40.11+675x217.5x40
	Number of circuits		5
Indoor air flow (Hi/Mi/Lo)		m <sup>3</sup> /h	575/497/340
Indoor sound pressure level (Hi/Mi/Lo)		dB(A)	43/34/24
Indoor sound power level		dB(A)	59
Indoor unit	Dimension(W*D*H)	mm	895x248x298
	Packing (W*D*H)	mm	985x370x350
	Net/Gross weight	kg	12.7/17.5
Outdoor fan motor	Model		ZKFN-34-10-1-3
	Output	W	34
	Capacitor	uF	/
	Speed	r/min	850/750/450
Outdoor coil	Number of rows		2.0
	Tube pitch(a)x row pitch(b)	mm	21x22
	Fin spacing	mm	1.3
	Fin type (code)		Hydrophilic aluminum
	Tube outside dia.and type	mm	Φ7,Inner groove tube
	Coil length x height x width	mm	860*504*44
	Number of circuits		4

Outdoor air flow		m <sup>3</sup> /h	2350
Outdoor sound pressure level		dB(A)	55.5
Outdoor sound power level		dB(A)	60
Outdoor unit	Dimension(W*D*H)	mm	805x330x554
	Packing (W*D*H)	mm	915x370x615
	Net/Gross weight	kg	32.3/34.8
Refrigerant	Type		R32
	GWP		675
	Charged quantity	kg	0.9
Design pressure		MPa	4.3/1.7
Refrigerant piping	Liquid side/ Gas side	mm(inch)	Φ6.35/Φ9.52(1/4"/3/8")
	Max. refrigerant pipe length	m	25
	Max. difference in level	m	10
Connection wiring			1.5x5Core
Plug type			no-plug
Thermostat type			Remote Control
Operation temperature			16-30
Ambient temperature	Indoor(cooling/ heating)	°C	16-32/0-30
	Outdoor(cooling/heating)	°C	-15-50/-15-30
Qty'per 20' /40' /40'HQ			82/170/198

## Notes:

1) Capacities are based on the following conditions:

Cooling(T1): - Indoor Temperature 27°C(80.6°F) DB /19 °C(66.2°F) WB

-Outdoor Temperature 35 °C(95°F) DB /24 °C(75.2°F) WB

-Interconnecting Piping Length 5m

- Level Difference of Zero.

Heating: - Indoor Temperature 20°C(68°F) DB / 15°C(59°F) WB

-Outdoor Temperature 7°C(44.6°F) DB / 6°C(42.8°F) WB

- Interconnecting Piping Length 5 m

- Level Difference of Zero.

2) Capacities are Net Capacities.

3) Due to our policy of innovation some specifications may be changed without notification.

### 3. Dimensional Drawings

#### 3.1 Indoor Unit

IH2-Y 27M-35M

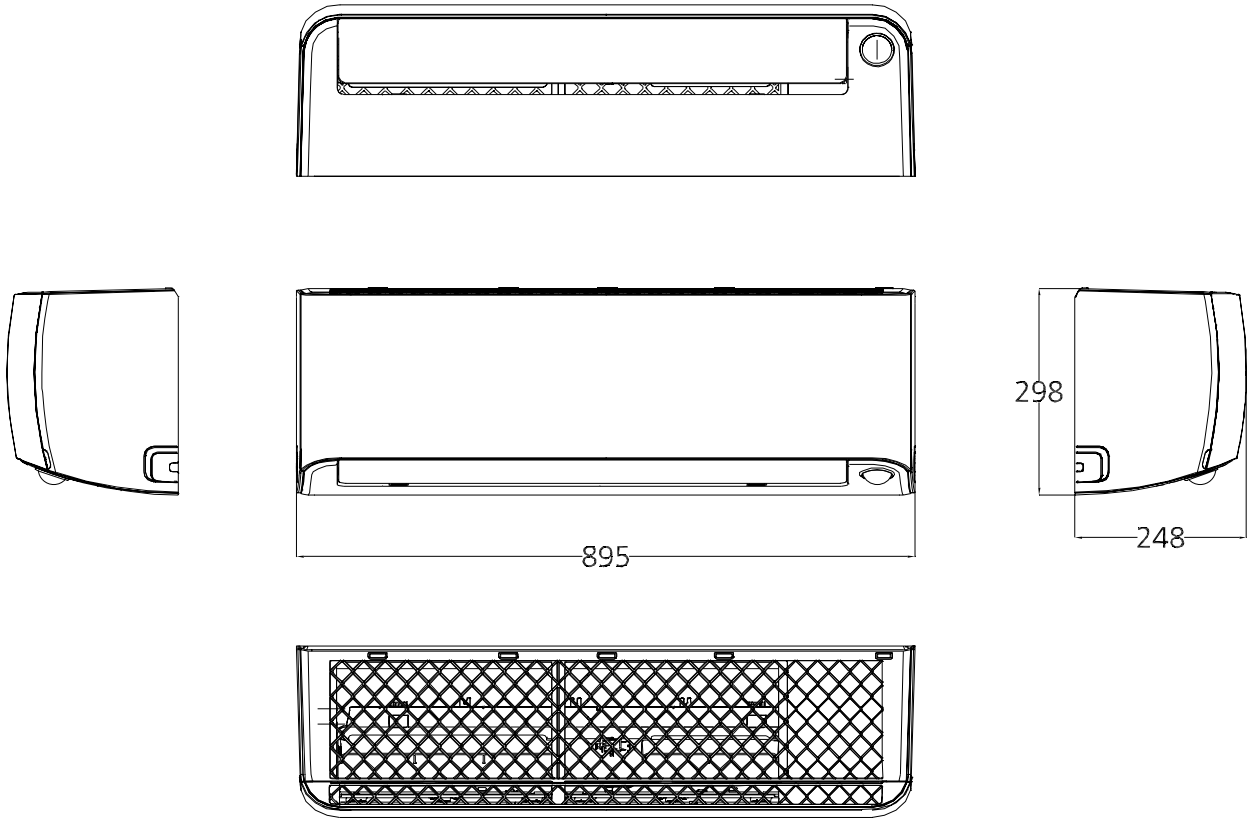

### 3.2 Outdoor Unit

MH2-Y 27M-35M

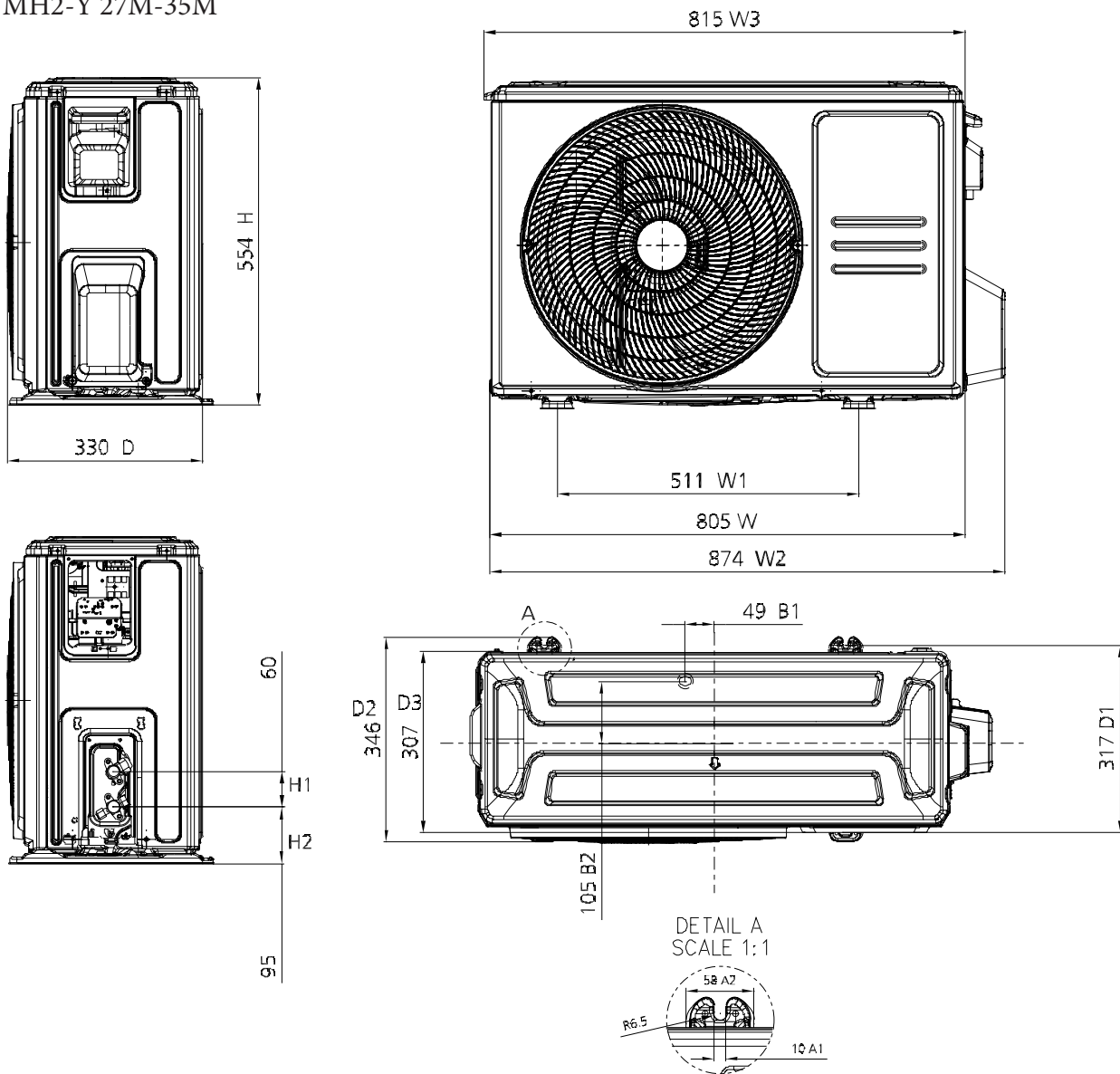

## 4. Electrical Wiring Diagrams

### 4.1 Indoor unit IH2-Y 27M-35M

Abbreviation	Paraphrase
Y/G	Yellow-Green Conductor
ION	Positive and Negative Ion Generator
CAP	Capacitor
PLASMA	Electronic Dust Collector
L	LIVE
N	NEUTRAL
T1	Indoor Room Temperature
T2	Coil Temperature of Indoor Heat Exchanger

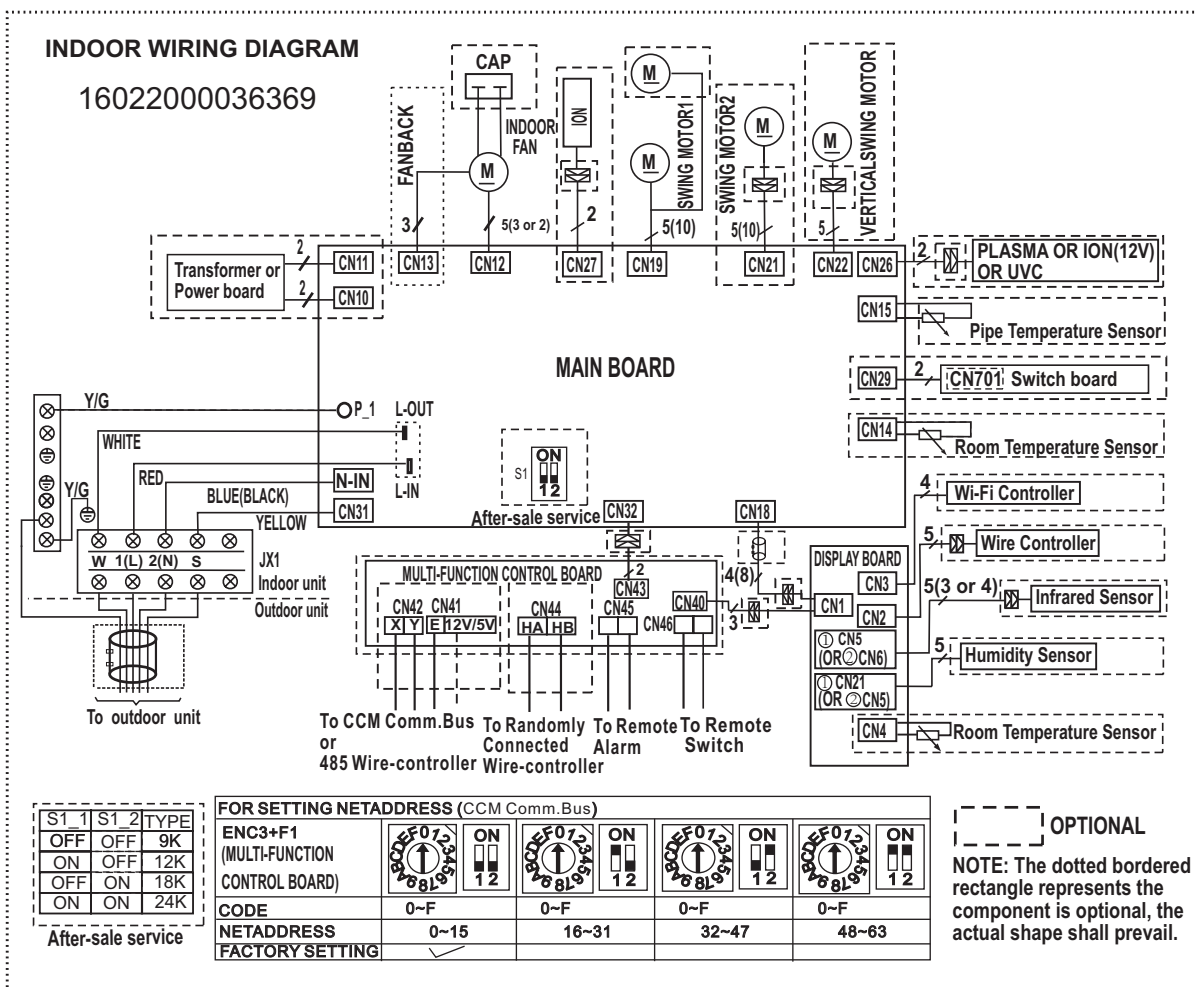

## 4.2 Outdoor Unit MH2-Y 27M-35M

Abbreviation	Paraphrase
4-WAY	Gas Valve Assembly/4-WAY VALVE
AC-FAN	Alternating Current FAN
DC-FAN	Direct Current FAN
COMP	Compressor

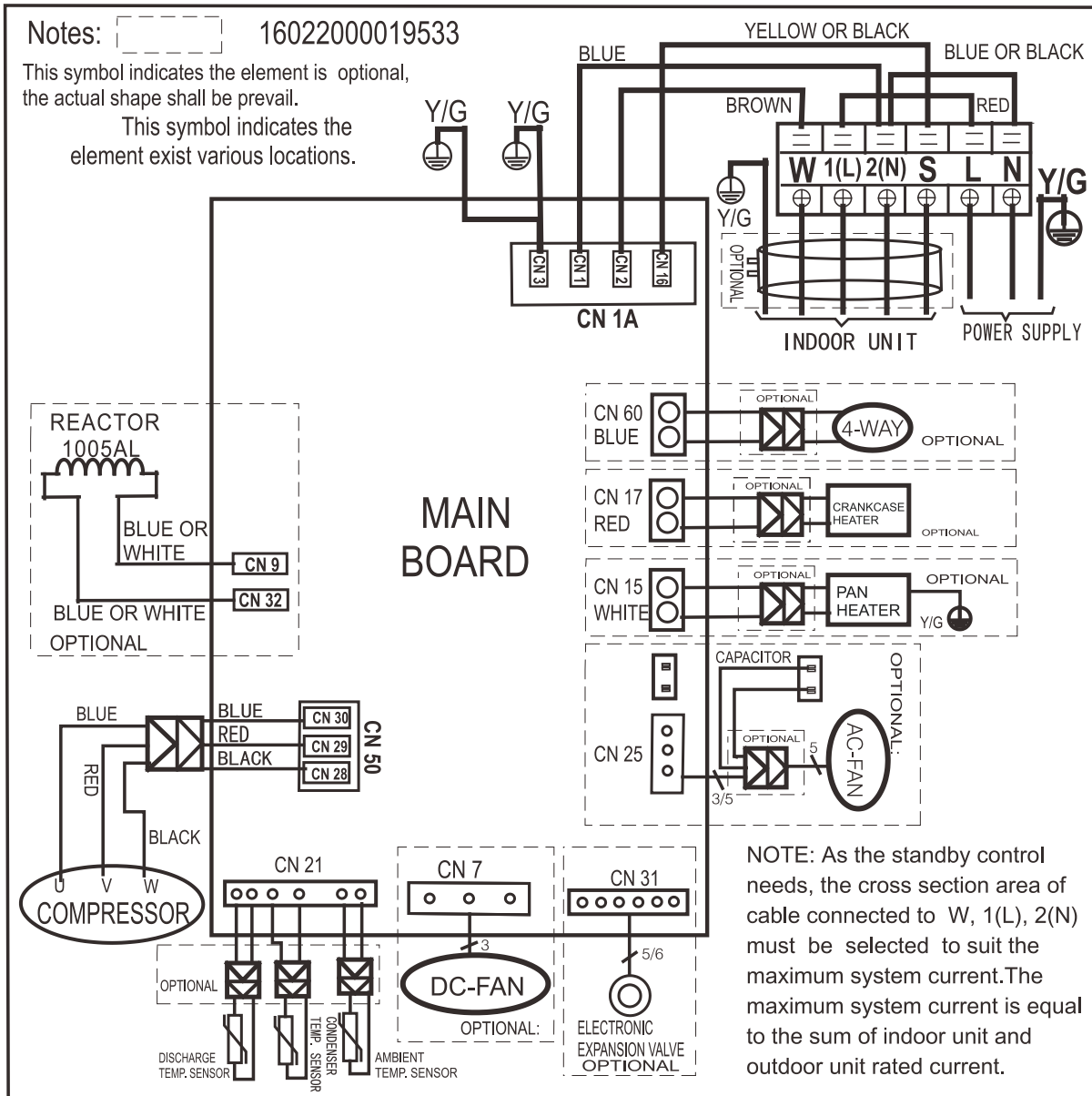

## 5. Refrigerant Cycle Diagrams

### 5.1 Heat pump

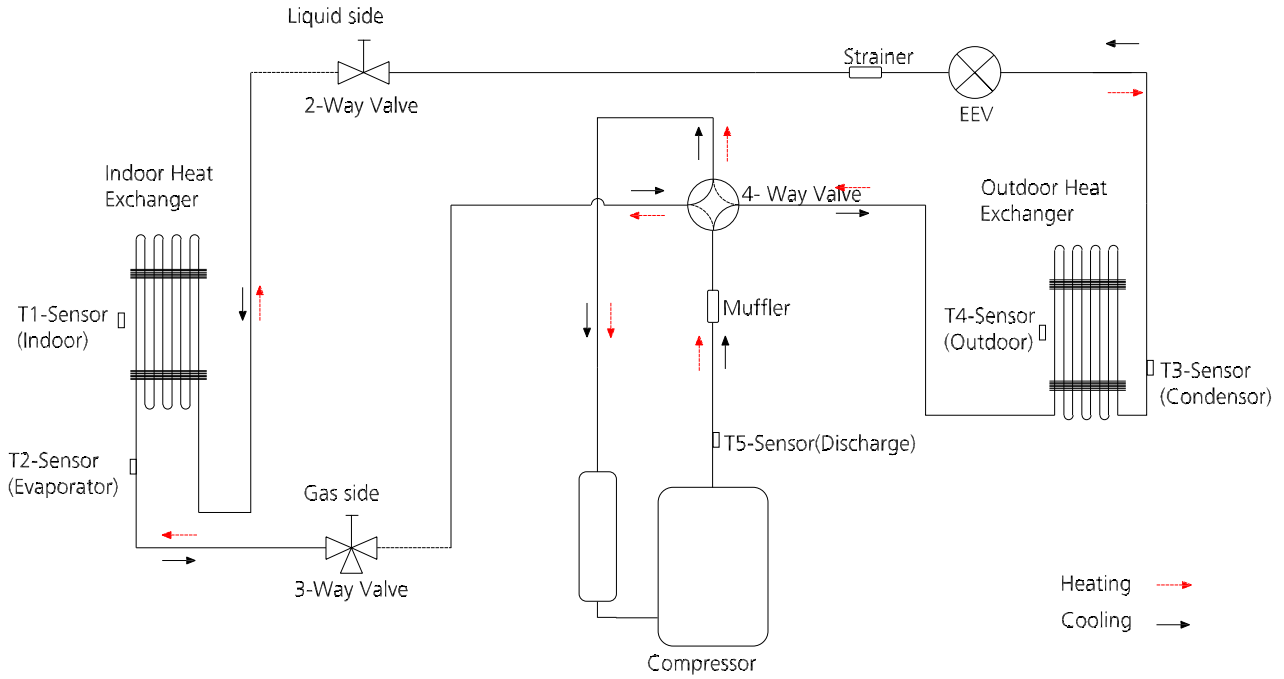

Size	Pipe Size (Diameter:ø) mm(inch)		Piping length (m/ft)		Elevation (m/ft)		Additional Refrigerant
	Gas	Liquid	Rated	Max.	Rated	Max.	
IH2-Y 27M-35M	9.52(3/8)	6.35(1/4)	5/16.4	25/82	0	10/32.8	12g/m (0.13oz/ft)

## 6. Capacity Tables

### 6.1 Cooling

		IH2-Y 27M-35M																
INDOOR AIRFLOW (CMH)	OUTDOOR DB(°C)	ID WB (°C)	16.0				18.0				19.0				22.0			
		ID DB (°C)	23.0	25.0	27.0	30.0	23.0	25.0	27.0	30.0	23.0	25.0	27.0	30.0	23.0	25.0	27.0	30.0
340	-15	TC	3.71	3.72	3.72	3.72	3.90	3.96	3.96	3.96	4.00	4.00	4.00	4.00	4.25	4.25	4.25	4.25
		S/T	0.66	0.72	0.78	0.85	0.55	0.61	0.67	0.72	0.49	0.55	0.61	0.67	0.38	0.42	0.48	0.53
		PI	0.49	0.49	0.49	0.49	0.50	0.50	0.50	0.50	0.50	0.50	0.50	0.50	0.49	0.49	0.49	0.49
	-10	TC	3.68	3.70	3.70	3.70	3.87	3.93	3.93	3.93	3.98	3.98	3.98	3.98	4.23	4.23	4.23	4.23
		S/T	0.66	0.73	0.79	0.85	0.55	0.61	0.67	0.73	0.49	0.55	0.61	0.67	0.38	0.43	0.49	0.53
		PI	0.49	0.49	0.49	0.49	0.49	0.49	0.49	0.49	0.49	0.49	0.49	0.49	0.49	0.49	0.49	0.49
	-5	TC	3.66	3.67	3.67	3.67	3.86	3.92	3.92	3.92	3.96	3.96	3.96	3.96	4.22	4.22	4.22	4.22
		S/T	0.66	0.73	0.79	0.86	0.56	0.61	0.67	0.73	0.50	0.56	0.61	0.67	0.38	0.43	0.49	0.54
		PI	0.49	0.49	0.49	0.49	0.49	0.49	0.49	0.49	0.49	0.49	0.49	0.49	0.49	0.49	0.49	0.49
	0	TC	3.64	3.66	3.66	3.66	3.85	3.91	3.91	3.91	3.95	3.95	3.95	3.95	4.22	4.22	4.22	4.22
		S/T	0.67	0.74	0.79	0.86	0.56	0.62	0.68	0.74	0.50	0.56	0.62	0.68	0.38	0.43	0.49	0.54
		PI	0.49	0.49	0.49	0.49	0.50	0.50	0.50	0.50	0.50	0.50	0.50	0.50	0.49	0.49	0.49	0.49
	5	TC	3.62	3.64	3.64	3.64	3.83	3.89	3.89	3.89	3.94	3.94	3.94	3.94	4.21	4.21	4.21	4.21
		S/T	0.67	0.74	0.80	0.87	0.56	0.62	0.68	0.74	0.50	0.56	0.62	0.68	0.38	0.43	0.49	0.54
		PI	0.50	0.50	0.50	0.50	0.50	0.50	0.50	0.50	0.50	0.50	0.50	0.50	0.49	0.49	0.49	0.49
	10	TC	3.60	3.61	3.61	3.61	3.81	3.87	3.87	3.87	3.92	3.92	3.92	3.92	4.20	4.20	4.20	4.20
		S/T	0.67	0.74	0.80	0.87	0.56	0.62	0.68	0.74	0.50	0.56	0.62	0.68	0.39	0.44	0.50	0.54
		PI	0.51	0.51	0.51	0.51	0.51	0.51	0.51	0.51	0.51	0.51	0.51	0.51	0.50	0.50	0.50	0.50
	15	TC	3.57	3.59	3.59	3.59	3.79	3.85	3.85	3.85	3.90	3.90	3.90	3.90	4.19	4.19	4.19	4.19
		S/T	0.68	0.75	0.81	0.88	0.57	0.63	0.69	0.75	0.51	0.57	0.63	0.69	0.39	0.44	0.50	0.55
		PI	0.52	0.52	0.52	0.52	0.52	0.52	0.52	0.52	0.52	0.52	0.52	0.52	0.51	0.51	0.51	0.51
	20	TC	3.53	3.54	3.54	3.54	3.75	3.75	3.75	3.75	3.86	3.86	3.86	3.86	4.15	4.15	4.15	4.15
		S/T	0.68	0.75	0.81	0.88	0.57	0.63	0.69	0.75	0.51	0.57	0.63	0.69	0.39	0.44	0.50	0.55
		PI	0.54	0.54	0.54	0.54	0.54	0.54	0.54	0.54	0.54	0.54	0.54	0.54	0.53	0.53	0.53	0.53
	25	TC	3.37	3.37	3.37	3.40	3.57	3.57	3.57	3.57	3.69	3.69	3.69	3.69	3.98	3.98	3.98	3.98
		S/T	0.69	0.75	0.82	0.89	0.57	0.63	0.70	0.76	0.51	0.57	0.64	0.70	0.39	0.44	0.50	0.56
		PI	0.60	0.60	0.60	0.60	0.59	0.59	0.59	0.59	0.59	0.59	0.59	0.59	0.60	0.60	0.60	0.60
	30	TC	3.20	3.20	3.20	3.23	3.43	3.43	3.43	3.43	3.52	3.52	3.52	3.52	3.80	3.80	3.80	3.80
		S/T	0.69	0.76	0.84	0.90	0.57	0.64	0.70	0.77	0.51	0.58	0.64	0.71	0.38	0.44	0.50	0.56
		PI	0.64	0.64	0.64	0.64	0.64	0.64	0.64	0.64	0.65	0.65	0.65	0.65	0.65	0.65	0.65	0.65
	35	TC	3.05	3.05	3.05	3.08	3.26	3.26	3.26	3.26	3.34	3.34	3.40	3.34	3.60	3.60	3.60	3.60
		S/T	0.70	0.77	0.85	0.92	0.57	0.64	0.71	0.78	0.51	0.58	0.65	0.72	0.38	0.44	0.50	0.57
		PI	0.70	0.70	0.70	0.70	0.71	0.71	0.71	0.71	0.71	0.71	0.71	0.71	0.71	0.71	0.71	0.71
	40	TC	2.89	2.89	2.91	2.93	3.09	3.09	3.09	3.09	3.18	3.18	3.21	3.18	3.43	3.43	3.43	3.43
		S/T	0.71	0.80	0.88	0.96	0.58	0.65	0.73	0.81	0.51	0.59	0.66	0.74	0.37	0.44	0.51	0.57
		PI	0.78	0.78	0.78	0.78	0.79	0.79	0.79	0.79	0.79	0.79	0.79	0.79	0.79	0.79	0.79	0.79
	46	TC	2.67	2.67	2.70	2.73	2.87	2.87	2.87	2.87	2.96	2.96	2.96	2.96	3.19	3.19	3.19	3.19
		S/T	0.72	0.81	0.89	0.97	0.58	0.66	0.74	0.82	0.51	0.59	0.67	0.75	0.36	0.44	0.51	0.58
		PI	0.87	0.87	0.87	0.87	0.87	0.87	0.87	0.87	0.88	0.88	0.88	0.88	0.88	0.88	0.88	0.88
	50	TC	2.53	2.53	2.55	2.58	2.70	2.70	2.70	2.70	2.79	2.79	2.79	2.79	3.02	3.02	3.02	3.02
		S/T	0.73	0.82	0.91	0.99	0.58	0.67	0.75	0.84	0.52	0.60	0.68	0.76	0.36	0.44	0.51	0.59
		PI	0.94	0.94	0.94	0.94	0.95	0.95	0.95	0.95	0.95	0.95	0.95	0.95	0.96	0.96	0.96	0.96

Specifications

497	-15	TC	3.78	3.78	3.81	3.84	3.96	3.96	3.96	3.96	4.06	4.06	4.06	4.06	4.31	4.31	4.31	4.31
		S/T	0.70	0.80	0.98	1.00	0.57	0.65	0.73	0.82	0.50	0.58	0.67	0.74	0.35	0.42	0.50	0.58
		PI	0.51	0.51	0.51	0.51	0.51	0.51	0.51	0.51	0.51	0.51	0.51	0.51	0.51	0.51	0.51	0.51
	-10	TC	3.76	3.76	3.79	3.82	3.93	3.93	3.93	3.93	4.04	4.04	4.04	4.04	4.29	4.29	4.29	4.29
		S/T	0.71	0.81	0.99	1.00	0.57	0.65	0.74	0.82	0.50	0.58	0.67	0.75	0.35	0.43	0.50	0.58
		PI	0.51	0.51	0.51	0.51	0.51	0.51	0.51	0.51	0.51	0.51	0.51	0.51	0.51	0.51	0.51	0.51
	-5	TC	3.73	3.73	3.76	3.79	3.92	3.92	3.92	3.92	4.02	4.02	4.02	4.02	4.28	4.28	4.28	4.28
		S/T	0.71	0.81	0.99	1.00	0.58	0.65	0.74	0.83	0.51	0.59	0.67	0.75	0.35	0.43	0.51	0.59
		PI	0.50	0.50	0.50	0.50	0.51	0.51	0.51	0.51	0.51	0.51	0.51	0.51	0.51	0.51	0.51	0.51
	0	TC	3.72	3.72	3.75	3.77	3.91	3.91	3.91	3.91	4.01	4.01	4.01	4.01	4.28	4.28	4.28	4.28
		S/T	0.72	0.81	1.00	1.00	0.58	0.66	0.74	0.83	0.51	0.59	0.68	0.75	0.35	0.43	0.51	0.59
		PI	0.51	0.51	0.51	0.51	0.51	0.51	0.51	0.51	0.51	0.51	0.51	0.51	0.51	0.51	0.51	0.51
	5	TC	3.70	3.70	3.73	3.76	3.89	3.89	3.89	3.89	4.00	4.00	4.00	4.00	4.27	4.27	4.27	4.27
		S/T	0.72	0.82	1.00	1.00	0.58	0.66	0.75	0.84	0.51	0.59	0.68	0.76	0.35	0.43	0.51	0.59
		PI	0.51	0.51	0.51	0.51	0.51	0.51	0.51	0.51	0.51	0.51	0.51	0.51	0.52	0.52	0.52	0.52
	10	TC	3.67	3.67	3.70	3.73	3.87	3.87	3.87	3.87	3.98	3.98	3.98	3.98	4.26	4.26	4.26	4.26
		S/T	0.72	0.82	1.00	1.00	0.58	0.66	0.75	0.84	0.51	0.59	0.68	0.76	0.36	0.44	0.51	0.59
		PI	0.52	0.52	0.52	0.52	0.52	0.52	0.52	0.52	0.52	0.52	0.52	0.52	0.52	0.52	0.52	0.52
	15	TC	3.64	3.64	3.67	3.70	3.85	3.85	3.85	3.85	3.96	3.96	3.96	3.96	4.25	4.25	4.25	4.25
		S/T	0.73	0.83	0.92	1.00	0.59	0.67	0.76	0.85	0.52	0.60	0.69	0.77	0.36	0.44	0.52	0.60
		PI	0.53	0.53	0.53	0.53	0.53	0.53	0.53	0.53	0.53	0.53	0.53	0.53	0.54	0.54	0.54	0.54
	20	TC	3.60	3.60	3.63	3.66	3.81	3.81	3.81	3.81	3.92	3.92	3.92	3.92	4.21	4.21	4.21	4.21
		S/T	0.73	0.83	0.92	1.00	0.59	0.67	0.76	0.85	0.52	0.60	0.69	0.77	0.36	0.44	0.52	0.60
		PI	0.55	0.55	0.55	0.55	0.55	0.55	0.55	0.55	0.55	0.55	0.55	0.55	0.55	0.55	0.55	0.55
25	TC	3.43	3.43	3.46	3.49	3.63	3.63	3.63	3.63	3.75	3.75	3.75	3.75	4.04	4.04	4.04	4.04	
	S/T	0.74	0.84	0.94	1.00	0.59	0.68	0.77	0.87	0.52	0.61	0.70	0.79	0.35	0.44	0.52	0.60	
	PI	0.61	0.61	0.61	0.61	0.61	0.61	0.61	0.61	0.61	0.61	0.61	0.61	0.61	0.61	0.61	0.61	
30	TC	3.26	3.26	3.29	3.32	3.49	3.49	3.49	3.49	3.57	3.57	3.57	3.57	3.86	3.86	3.86	3.86	
	S/T	0.76	0.86	0.96	1.00	0.60	0.69	0.79	0.88	0.52	0.62	0.71	0.80	0.35	0.44	0.52	0.61	
	PI	0.67	0.67	0.67	0.67	0.67	0.67	0.67	0.67	0.67	0.67	0.67	0.67	0.67	0.67	0.67	0.67	
35	TC	3.11	3.11	3.14	3.17	3.32	3.32	3.32	3.34	3.40	3.40	3.46	3.40	3.66	3.66	3.66	3.66	
	S/T	0.77	0.88	0.98	1.00	0.60	0.70	0.80	0.90	0.52	0.62	0.72	0.82	0.35	0.44	0.53	0.62	
	PI	0.73	0.73	0.73	0.73	0.74	0.74	0.74	0.74	0.74	0.74	0.74	0.74	0.74	0.74	0.74	0.74	
40	TC	2.89	2.91	2.94	2.96	3.08	3.08	3.08	3.11	3.17	3.17	3.20	3.17	3.42	3.42	3.42	3.42	
	S/T	0.80	0.91	1.00	1.00	0.62	0.73	0.84	0.95	0.53	0.64	0.75	0.85	0.34	0.44	0.54	0.64	
	PI	0.81	0.81	0.81	0.81	0.82	0.82	0.82	0.82	0.82	0.82	0.82	0.82	0.82	0.82	0.82	0.82	
46	TC	2.68	2.71	2.73	2.76	2.85	2.85	2.85	2.88	2.93	2.93	2.93	2.93	3.19	3.19	3.19	3.19	
	S/T	0.81	0.93	1.00	1.00	0.62	0.74	0.85	0.97	0.54	0.65	0.76	0.87	0.34	0.44	0.55	0.65	
	PI	0.90	0.90	0.90	0.90	0.91	0.91	0.91	0.91	0.91	0.91	0.91	0.91	0.92	0.92	0.92	0.92	
50	TC	2.51	2.53	2.56	2.59	2.68	2.68	2.68	2.71	2.76	2.76	2.79	2.79	3.02	3.02	3.02	3.02	
	S/T	0.83	0.96	1.00	1.00	0.63	0.76	0.88	1.00	0.54	0.66	0.78	0.90	0.34	0.44	0.55	0.91	
	PI	0.98	0.98	0.98	0.98	0.98	0.98	0.98	0.98	0.98	0.98	0.98	0.98	0.99	0.99	0.99	0.99	
575	-15	TC	3.84	3.84	3.87	3.90	4.02	4.02	4.02	4.05	4.12	4.12	4.12	4.12	4.40	4.40	4.40	4.40
		S/T	0.73	0.84	1.00	1.00	0.58	0.68	0.77	0.98	0.50	0.60	0.70	0.79	0.34	0.42	0.51	0.60
		PI	0.52	0.52	0.52	0.52	0.52	0.52	0.52	0.52	0.52	0.52	0.52	0.52	0.52	0.52	0.52	0.52
	-10	TC	3.82	3.82	3.85	3.88	3.99	3.99	3.99	4.02	4.10	4.10	4.10	4.10	4.38	4.38	4.38	4.38
		S/T	0.74	0.84	1.00	1.00	0.58	0.68	0.78	0.98	0.50	0.60	0.70	0.80	0.34	0.43	0.51	0.60
		PI	0.51	0.51	0.51	0.51	0.51	0.51	0.51	0.51	0.51	0.51	0.51	0.51	0.51	0.51	0.51	0.51
	-5	TC	3.79	3.79	3.82	3.85	3.98	3.98	3.98	4.01	4.08	4.08	4.08	4.08	4.37	4.37	4.37	4.37
		S/T	0.74	0.85	1.00	1.00	0.59	0.68	0.78	0.99	0.51	0.60	0.70	0.80	0.34	0.43	0.52	0.60
		PI	0.51	0.51	0.51	0.51	0.52	0.52	0.52	0.52	0.52	0.52	0.52	0.52	0.52	0.52	0.52	0.52
	0	TC	3.77	3.77	3.80	3.83	3.96	3.96	3.96	3.99	4.07	4.07	4.07	4.07	4.37	4.37	4.37	4.37
		S/T	0.74	0.85	1.00	1.00	0.59	0.69	0.78	0.99	0.51	0.61	0.71	0.80	0.34	0.43	0.52	0.61
		PI	0.52	0.52	0.52	0.52	0.52	0.52	0.52	0.52	0.52	0.52	0.52	0.52	0.52	0.52	0.52	0.52
	5	TC	3.76	3.76	3.79	3.82	3.95	3.95	3.95	3.98	4.06	4.06	4.06	4.06	4.36	4.36	4.36	4.36
		S/T	0.75	0.86	1.00	1.00	0.59	0.69	0.79	1.00	0.51	0.61	0.71	0.81	0.34	0.43	0.52	0.61
		PI	0.52	0.52	0.52	0.52	0.52	0.52	0.52	0.52	0.52	0.52	0.52	0.52	0.53	0.53	0.53	0.53
	10	TC	3.73	3.73	3.76	3.79	3.93	3.93	3.93	3.96	4.04	4.04	4.04	4.04	4.35	4.35	4.35	4.35
		S/T	0.75	0.86	1.00	1.00	0.59	0.69	0.79	1.00	0.51	0.61	0.71	0.81	0.35	0.44	0.52	0.61
		PI	0.53	0.53	0.53	0.53	0.53	0.53	0.53	0.53	0.53	0.53	0.53	0.53	0.53	0.53	0.53	0.53
	15	TC	3.70	3.70	3.73	3.76	3.90	3.90	3.90	3.93	4.02	4.02	4.02	4.02	4.33	4.33	4.33	4.33
		S/T	0.76	0.87	0.97	1.00	0.60	0.70	0.80	0.90	0.52	0.62	0.72	0.82	0.35	0.44	0.53	0.62
		PI	0.54	0.54	0.54	0.54	0.54	0.54	0.54	0.54	0.54	0.54	0.54	0.54	0.54	0.54	0.54	0.54
	20	TC	3.66	3.66	3.69	3.72	3.86	3.86	3.86	3.89	3.98	3.98	3.98	3.98	4.30	4.30	4.30	4.30
		S/T	0.76	0.87	0.97	1.00	0.60	0.70	0.80	0.90	0.52	0.62	0.72	0.82	0.35	0.44	0.53	0.62
		PI	0.56	0.56	0.56	0.56	0.56	0.56	0.56	0.56	0.56	0.56	0.56	0.56	0.56	0.56	0.56	0.56
25	TC	3.49	3.52	3.55	3.57	3.69	3.69	3.69	3.72	3.81	3.81	3.81	3.81	4.09	4.09	4.09	4.09	
	S/T	0.78	0.88	0.99	1.00	0.61	0.71	0.82	0.92	0.53	0.63	0.73	0.83	0.34	0.44	0.53	0.63	
	PI	0.62	0.62	0.62	0.62	0.62	0.62	0.62	0.62	0.62	0.62	0.62	0.62	0.62	0.62	0.62	0.62	
30	TC	3.32	3.34	3.37	3.40	3.55	3.55	3.55	3.57	3.63	3.63	3.63	3.63	3.92	3.92	3.92	3.92	
	S/T	0.79	0.90	1.00	1.00	0.61	0.72	0.83	0.94	0.53	0.64	0.74	0.85	0.34	0.44	0.54	0.64	
	PI	0.68	0.68	0.68	0.68	0.68	0.68	0.68	0.68	0.68	0.68	0.68	0.68	0.69	0.69	0.69	0.69	
35	TC	3.14	3.17	3.20	3.23	3.37	3.37	3.37	3.40	3.46	3.46	<b>3.52</b>	3.46	3.75	3.75	3.75	3.75	
	S/T	0.81	0.93	1.00	1.00	0.62	0.73	0.85	0.96	0.54	0.65	<b>0.75</b>	0.87	0.34	0.44	0.55	0.65	
	PI	0.74	0.74	0.74	0.74	0.75	0.75	0.75	0.75	0.75	0.75	<b>0.75</b>	0.75	0.75	0.75	0.75	0.75	
40	TC	2.92	2.95	2.98	3.01	3.14	3.14	3.15	3.18	3.22	3.22	3.25	3.24	3.50	3.50	3.50	3.50	
	S/T	0.84	0.97	1.00	1.00	0.64	0.76	0.89	1.00	0.54	0.67	0.79	0.91	0.33	0.45	0.56	0.90	
	PI	0.82	0.82	0.82	0.82	0												

## 6.2 Heating

IH2-Y 27M-35M								[SI_Unit]	
INDOOR AIRFLOW (CMH)	HEATING PERFORMANCE AT INDOOR DRY BULB TEMPERATURE								
	OUTDOOR DB(°C)	TC:TOTAL CAPACITY IN KILOWATTS (KW)				PI:TOTAL POWER IN KILOWATTS (KW)			
		Indoor Conditions (DB °C )				Indoor Conditions (DB °C )			
		16.0	20.0	22.0	24.0	16.0	20.0	22.0	24.0
340	-15.0	3.54	3.52	3.49	3.46	1.42	1.47	1.42	1.42
	-10.0	3.78	3.76	3.73	3.70	1.52	1.57	1.52	1.52
	-7.0	3.96	3.93	3.91	3.88	1.61	1.67	1.61	1.61
	-5.6	3.93	3.91	3.88	3.85	1.54	1.54	1.53	1.53
	-2.8	3.88	3.85	3.82	3.79	1.41	1.40	1.40	1.39
	0.0	3.79	3.73	3.73	3.70	1.30	1.28	1.27	1.27
	2.8	3.82	3.79	3.76	3.73	1.18	1.16	1.15	1.14
	5.6	3.99	3.93	3.91	3.88	1.06	1.03	1.02	1.01
	7.0	4.19	4.13	4.10	4.08	1.00	0.90	0.96	0.94
	11.1	4.25	4.19	4.16	4.13	0.82	0.78	0.77	0.75
	13.9	4.28	4.22	4.19	4.13	0.71	0.66	0.64	0.62
	16.7	4.31	4.25	4.19	4.16	0.58	0.53	0.51	0.48
18.0	4.31	4.25	4.22	4.19	0.52	0.47	0.45	0.42	
497	-15.0	3.63	3.60	3.57	3.55	1.44	1.49	1.44	1.44
	-10.0	3.87	3.84	3.82	3.79	1.54	1.59	1.54	1.54
	-7.0	4.06	4.03	4.00	3.97	1.63	1.69	1.63	1.63
	-5.6	4.02	3.99	3.96	3.93	1.56	1.56	1.55	1.55
	-2.8	3.96	3.93	3.91	3.88	1.43	1.42	1.42	1.41
	0.0	3.88	3.82	3.82	3.79	1.31	1.30	1.29	1.28
	2.8	3.91	3.85	3.85	3.82	1.19	1.17	1.16	1.15
	5.6	4.08	4.02	3.99	3.96	1.07	1.05	1.03	1.02
	7.0	4.28	4.22	4.19	4.16	1.01	0.92	0.97	0.96
	11.1	4.34	4.28	4.25	4.19	0.83	0.79	0.77	0.77
	13.9	4.37	4.31	4.25	4.22	0.72	0.67	0.65	0.63
	16.7	4.40	4.34	4.28	4.25	0.59	0.54	0.52	0.49
18.0	4.40	4.34	4.31	4.28	0.53	0.48	0.46	0.43	
575	-15.0	3.70	3.65	3.65	3.62	1.46	1.51	1.46	1.46
	-10.0	3.95	3.89	3.89	3.87	1.55	1.61	1.55	1.55
	-7.0	4.14	4.08	4.08	4.05	1.65	1.71	1.65	1.65
	-5.6	4.08	4.02	4.02	3.99	1.58	1.57	1.57	1.57
	-2.8	4.02	3.96	3.96	3.93	1.45	1.44	1.43	1.43
	0.0	3.91	3.88	3.85	3.82	1.33	1.31	1.30	1.29
	2.8	3.93	3.91	3.88	3.85	1.20	1.18	1.17	1.16
	5.6	4.11	4.05	4.02	3.99	1.08	1.06	1.04	1.03
	7.0	4.31	4.25	4.22	4.19	1.02	0.92	0.98	0.96
	11.1	4.34	4.28	4.25	4.22	0.84	0.80	0.78	0.77
	13.9	4.37	4.31	4.28	4.25	0.72	0.68	0.65	0.63
	16.7	4.40	4.34	4.31	4.28	0.59	0.54	0.52	0.49
18.0	4.42	4.37	4.31	4.28	0.53	0.48	0.45	0.43	

Note: The table shows the case where the operation frequency of a compressor is fixed.

## 7. Noise Criterion Curves

### 7.1 Indoor Unit

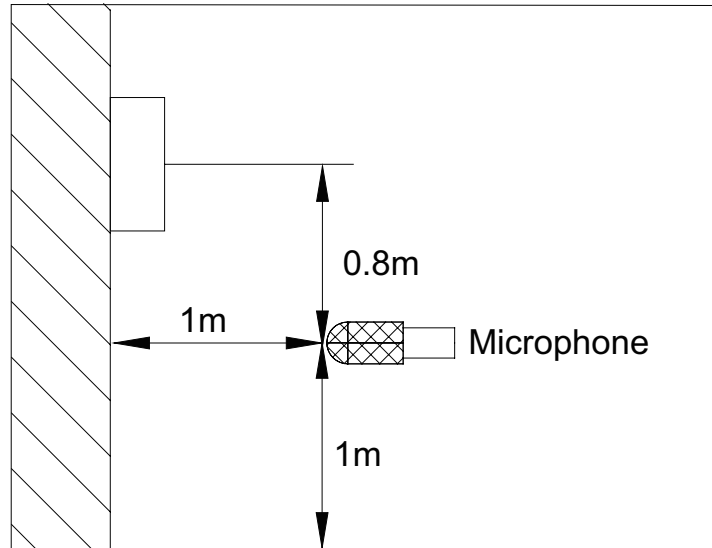

Notes:

- Sound measured at 1.0m away from the center of the unit.
- Data is valid at free field condition
- Data is valid at nominal operation condition
- Reference acoustic pressure  $OdB = 20\mu Pa$
- Sound level will vary depending on a range of factors such as the construction -(acoustic absorption coefficient) of particular room in which the equipment is installed.
- The operating conditions are assumed to be standard.

IH2-Y 27M-35M

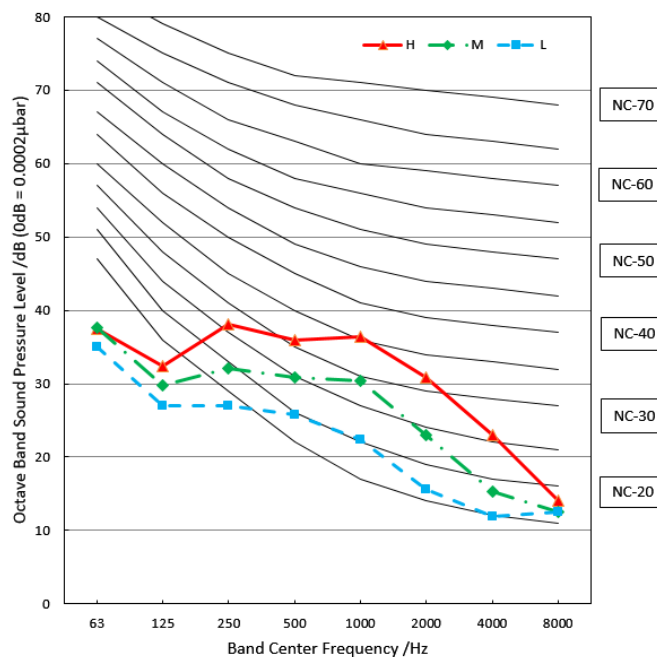

## 7.2 Outdoor Unit

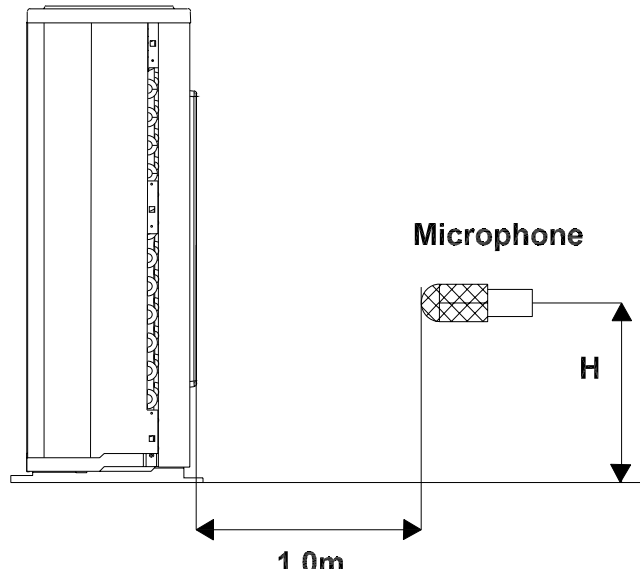

Note:  $H = 0.5 \times \text{height of outdoor unit}$

Notes:

- Sound measured at 1.0m away from the center of the unit.
- Data is valid at free field condition
- Data is valid at nominal operation condition
- Reference acoustic pressure  $OdB=20\mu Pa$
- Sound level will vary depending on arrange off actors such as the construction (acoustic absorption coefficient) of particular room in which the equipment is installed.
- The operating conditions are assumed to be standard.

MH2-Y 27M-35M

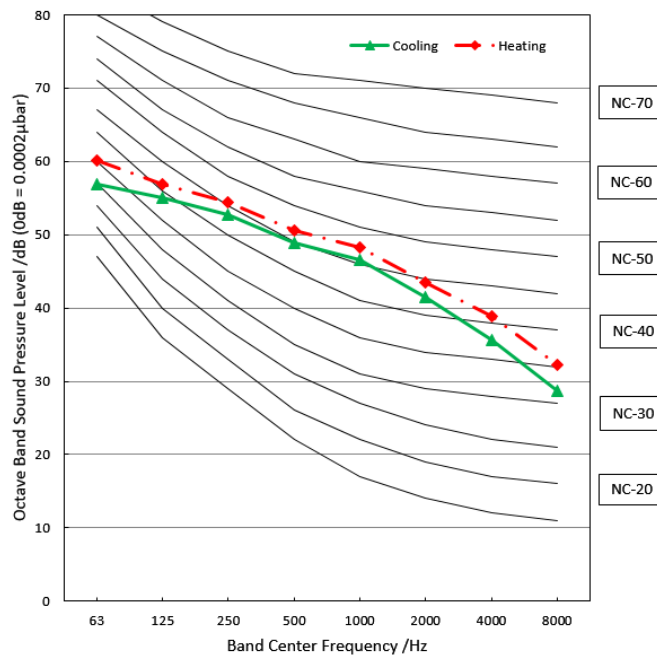

## 8. Electrical Characteristics

Size	Indoor Unit			Power Supply		IFM	
	Phase	Hz	Voltage	MCA	MOP	W	FLA
IH2-Y 27M-35M	1	50	220-240	/	/	20	0.1

Size	Outdoor Unit			Power Supply			Compressor		OFM		
	Phase	Hz	Voltage	MCA	MOP	MFA	MSC	RLA	Qty	W	FLA
MH2-Y 27M-35M	1	50	220-240	6.8	11.5	20	/	4.65	1	34	0.89

Notes:

MCA: Minimum Circuit Amperes (A)

MOP: Maximum rating over current protective device

MFA: Maximum Fuse Amperes (A)

MSC: Maximum Starting Current

RLA: Rated Load Amperes (A)

IFM: Indoor Fan Motor

OFM: Outdoor Fan Motor

FLA: Full Load Amperes (A)

---

# Product Features

## Contents



<b>1.</b>	<b>Operation Modes and Functions .....</b>	<b>19</b>
1.1	Display Function .....	19
1.2	Abbreviation.....	20
1.3	Safety Features .....	20
1.4	Fan Mode.....	20
1.5	Cooling Mode .....	20
1.6	Heating Mode(Heat Pump Units) .....	21
1.7	Auto Mode.....	22
1.8	Drying Mode .....	22
1.9	Forced Operation Function .....	22
1.10	Timer Function .....	22
1.11	Sleep Function.....	22
1.12	Follow Me(Optional).....	22
1.13	Auto-Restart Function.....	23
1.14	8°C&12°C Heating .....	23
1.15	Silence .....	23
1.16	Self Clean(Optional).....	23
1.17	ECO Function .....	23
1.18	Electrical Energy Consumption Control Function .....	23
1.19	Intelligent Eye.....	23
1.20	Wireless control(optional) .....	23
<b>2.</b>	<b>Remote Controller Functions .....</b>	<b>24</b>
2.1	Infrared Wireless Remote Controller.....	24

# 1. Operation Modes and Functions

## 1.1 Display Function

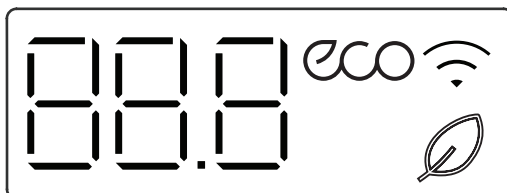
Unit display functions



Function	Display
Temperature	Set temperature value
Temperature (fan and Drying mode)	Room temperature
Activation of Timer ON, Fresh, Swing, Turbo, or Silent	<b>ON</b> (3s)
Cancellation of Timer OFF, Fresh, Swing, Turbo, or Silent	<b>OF</b> (3s)
Defrost	<b>df</b>
Self-clean (available on select units only)	<b>SC</b>
Heating in room temperature under 8°C or 12°C	<b>FP</b>
Fresh(available on select units only)	
ECO function (available on select units only)	<b>eco</b>
WiFi control (available on select units only)	

## 1.2 Abbreviation

Unit element abbreviations

Abbreviation	Element
T1	Indoor room temperature
T2	Coil temperature of evaporator
T3	Coil temperature of condenser
T4	Outdoor ambient temperature
TP	Compressor discharge temperature

## 1.3 Safety Features

### Compressor three-minute delay at restart

Compressor functions are delayed for up to one minute upon the first startup of the unit, and are delayed for up to three minutes upon subsequent unit restarts.

### Automatic shutoff based on discharge temperature

If the compressor discharge temperature exceeds a certain level for a period of time, the compressor ceases operation.

### Automatic shutoff based on fan speed

If the indoor fan speed registers below 300RPM for an extended period of time, the unit ceases operation and the corresponding error code is displayed on the indoor unit.

### Inverter module protection

The inverter module has an automatic shutoff mechanism based on the unit's current, voltage, and temperature. If automatic shutoff is initiated, the corresponding error code is displayed on the indoor unit and the unit ceases operation.

### Indoor fan delayed operation

- When the unit starts, the louver is automatically activated and the indoor fan will operate after a period of setting time or the louver is in place.
- If the unit is in heating mode, the indoor fan is regulated by the anti-cold wind function.

### Sensor redundancy and automatic shutoff

- If one temperature sensor malfunctions, the air conditioner continues operation and displays the corresponding error code, allowing for emergency use.
- When more than one temperature sensor is malfunctioning, the air conditioner ceases operation.

## 1.4 Fan Mode

When fan mode is activated:

- The outdoor fan and compressor cease operation.
- Temperature control is disabled and indoor room temperature is displayed.
- The indoor fan speed can be set to 1%~100%, or auto.
- The louver operations are identical to those in cooling mode.
- Auto fan: In fan-only mode, AC operates the same as auto fan in cooling mode with the temperature set at 24°C.(Tsc =24°C)

## 1.5 Cooling Mode

### 1.5.1 Compressor Control

Reach the configured temperature:

- 1) When the compressor runs continuously for within 120 minutes.
  - If the following conditions are satisfied, the compressor ceases operation.
    - Calculated frequency(fb) is less than minimum limit frequency(FminC).
    - Compressor runs at FminC more than 10 minutes
    - T1 is lower than or equal to (Tsc-CDIFTEMP-0.5°C)

Note: CDIFTEMP is EEPROM setting parameter. It is 2°C usually.

- 2) When the compressor runs continuously for more than 120 minutes.
  - If the following conditions are satisfied, the compressor ceases operation.
    - Calculated frequency(fb) is less than minimum limit frequency(FminC).
    - Compressor runs at FminC more than 10 minutes.
    - T1 is lower than or equal to (Tsc-CDIFTEMP).

Note: CDIFTEMP is EEPROM setting parameter. It is 2°C usually.

- 3) If one of the following conditions is satisfied, not judge protective time.
  - Compressor running frequency(fr) is more than test frequency(TestFre).
  - Compressor running frequency is equal to test frequency, T4 is more than 15°C or T4 fault.
  - Change setting temperature.
  - Turbo or sleep function on/off
  - Various frequency limit shutdown occurs.

### 1.5.2 Indoor Fan Control

1) In cooling mode, the indoor fan operates continuously. The fan speed can be set to 1%-100%, or auto.

2) Auto fan

- Descent curve
  - When T1-Tsc is lower than or equal to 3.5°C, fan speed reduces to 80%;
  - When T1-Tsc is lower than or equal to 1°C, fan speed reduces to 60%;
  - When T1-Tsc is lower than or equal to 0.5°C, fan speed reduces to 40%;
  - When T1-Tsc is lower than or equal to 0°C, fan speed reduces to 20%;
  - When T1-Tsc is lower than or equal to -0.5°C, fan speed reduces to 1%.
- Rise curve
  - When T1-Tsc is higher than 0°C, fan speed increases to 20%;
  - When T1-Tsc is higher than 0.5°C, fan speed increases to 40%;
  - When T1-Tsc is higher than 1°C, fan speed increases to 60%;
  - When T1-Tsc is higher than 1.5°C, fan speed increases to 80%;
  - When T1-Tsc is higher than 4°C, fan speed increases to 100%.

### 1.5.3 Outdoor Fan Control

- The outdoor unit will be run at different fan speed according to T4 and compressor running frequency..
- For different outdoor units, the fan speeds are different.

### 1.5.4 Condenser Temperature Protection

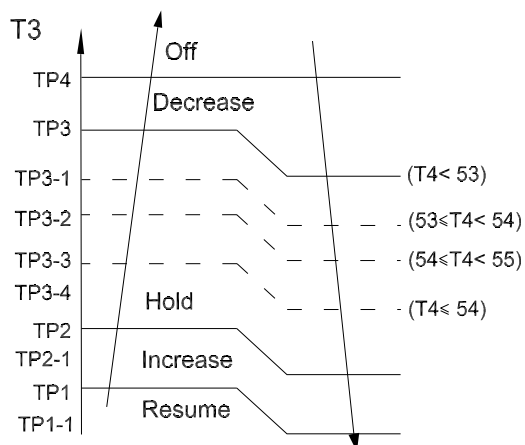

When the condenser temperature exceeds a configured value, the compressor ceases operation.

### 1.5.5 Evaporator Temperature Protection

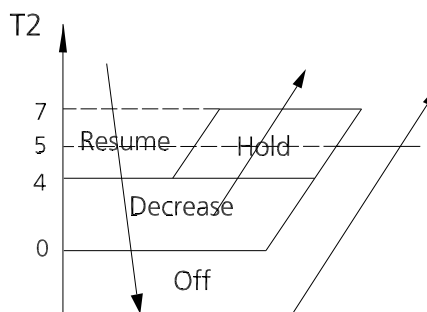

- Off: Compressor stops.
- Decrease: Decrease the running frequency to the lower level per 1 minute.
- Hold: Keep the current frequency.
- Resume: No limitation for frequency.

## 1.6 Heating Mode(Heat pump units)

### 1.6.1 Compressor Control

1) Reach the configured temperature

- If the following conditions are satisfied, the compressor ceases operation.
  - Calculated frequency(fb) is less than minimum limit frequency(FminH).
  - Compressor runs at FminH more than 10 minutes.
  - T1 is higher than or equal to Tsc+ HDIFTEMP2.

Note: HDIFTEMP2 is EEPROM setting parameter. It is 2°C usually.

- If one of the following conditions is satisfied, not judge protective time.
  - Compressor running frequency(fr) is more than test frequency(TestFre).
  - When compressor running frequency is equal to test frequency, T4 is more than 15°C or T4 fault.
  - Change setting temperature.
  - Turbo or sleep function on/off.

2) When the current is higher than the predefined safe value, surge protection is activated, causing the compressor to cease operations.

### 1.6.2 Indoor Fan Control:

1) In heating mode, the indoor fan operates continuously. The fan speed can be set to 1%-100%, or mute. And the anti-cold wind function has the priority.

- Anti-cold air function
  - The indoor fan is controlled by the indoor temperature T1 and indoor unit coil temperature

T2.

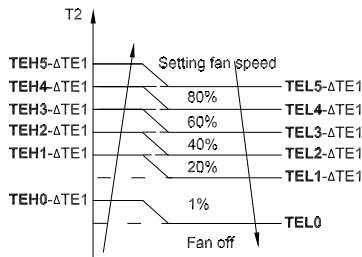

$T1 \geq 19^{\circ}\text{C} (66.2^{\circ}\text{F})$	$\Delta\text{TE1}=0$
$15^{\circ}\text{C} (59^{\circ}\text{F}) \leq T1 < 19^{\circ}\text{C} (66.2^{\circ}\text{F})$	$\Delta\text{TE1}=19^{\circ}\text{C}-T1$ ( $34.2^{\circ}\text{F}-T1$ )
$T1 < 15^{\circ}\text{C} (59^{\circ}\text{F})$	$\Delta\text{TE1}=4^{\circ}\text{C} (7.2^{\circ}\text{F})$

## 2) Auto fan

- Rise curve
  - When T1-Tsc is higher than  $-1.5^{\circ}\text{C}$ , fan speed reduces to 80%;
  - When T1-Tsc is higher than  $0^{\circ}\text{C}$ , fan speed reduces to 60%;
  - When T1-Tsc is higher than  $0.5^{\circ}\text{C}$ , fan speed reduces to 40%;
  - When T1-Tsc is higher than  $1^{\circ}\text{C}$ , fan speed reduces to 20%.
- Descent curve
  - When T1-Tsc is lower than or equal to  $0.5^{\circ}\text{C}$ , fan speed increases to 40%;
  - When T1-Tsc is lower than or equal to  $0^{\circ}\text{C}$ , fan speed increases to 60%;
  - When T1-Tsc is lower than or equal to  $-1.5^{\circ}\text{C}$ , fan speed increases to 80%;
  - When T1-Tsc is lower than or equal to  $-3^{\circ}\text{C}$ , fan speed increases to 100%.

### 1.6.3 Outdoor Fan Control:

- The outdoor unit will be run at different fan speed according to T4 and compressor running frequency.
- For different outdoor units, the fan speeds are different.

### 1.6.4 Defrosting Mode

- The unit enters defrosting mode according to changes in the temperature value of T3, T4 as well as the compressor running time.
- In defrosting mode, the compressor continues to run, the indoor and outdoor motor will cease operation, the defrost light of the indoor unit will turn on, and the "df" symbol is displayed.
- If any one of the following conditions is satisfied, defrosting ends and the machine switches to normal heating mode:

- T3 rises above  $\text{TCDE1}^{\circ}\text{C}$ .
- T3 maintained above  $\text{TCDE2}^{\circ}\text{C}$  for 80 seconds.
- Unit runs for 15 minutes consecutively in defrosting mode.
- If T4 is lower than or equal to  $-22^{\circ}\text{C}$  and compressor running time is more than  $\text{TIMING\_DEFROST\_TIME}$ , if any one of the following conditions is satisfied, defrosting ends and the machine switches to normal heating mode:
  - Unit runs for 10 minutes consecutively in defrosting mode.
  - T3 rises above  $10^{\circ}\text{C}$ .

### 1.6.5 Evaporator Temperature Protection

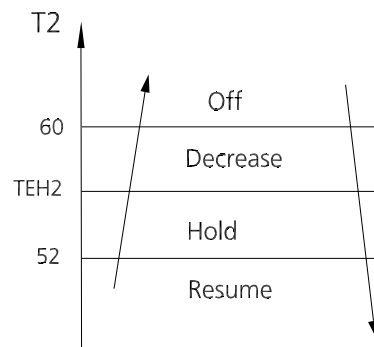

- Off: Compressor stops.
- Decrease: Decrease the running frequency to the lower level per 20 seconds.
- Hold: Keep the current frequency.
- Resume: No limitation for frequency.

### 1.7 Auto-mode

- This mode can be selected with the remote controller and the setting temperature can be changed between  $16^{\circ}\text{C} \sim 30^{\circ}\text{C}$ .
- In auto mode, the machine selects cooling, heating, auto-drying or fan-only mode on the basis of T1, Ts, T4 and relative humidity.

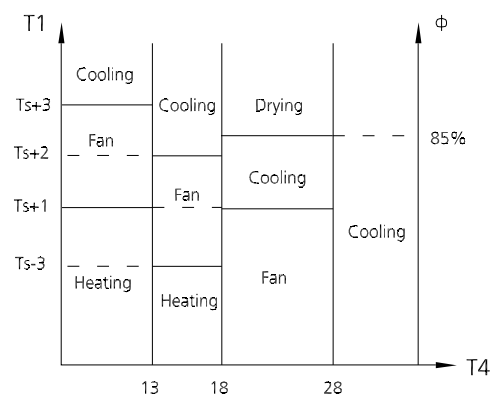

- If the setting temperature is modified, the machine selects a new running function.

## 1.8 Drying Mode

- In drying mode, AC operates the same as auto fan in cooling mode.
- All protections are activated and operate the same as they do that in cooling mode.
- Low Room Temperature Protection

If the room temperature is lower than 10°C, the compressor ceases operations and does not resume until room temperature exceeds 12°C.

## 1.9 Forced Operation Function

- Forced cooling mode:

The compressor and outdoor fan continue to run (fixed at rated frequency), and the indoor fan runs at rated speed. After running for 30 minutes, the AC will switch to auto mode with a preset temperature of 24°C.

- Forced auto mode:

Forced auto mode operates the same as normal auto mode with a preset temperature of 24°C.

- The unit exits forced operation when it receives the following signals:
  - Switch on
  - Switch off
  - Timer on
  - Timer off
  - Sleep mode
  - Follow me
  - Changes in:
    - mode
    - fan speed
    - setting temperature
- Forced defrosting mode:
  - Press AUTO/COOL button continuously for 5s under forced cooling mode to enter this mode.
  - Indoor fan will stop, defrosting lamp will light on.
  - Quit this mode and turn off the unit when:
    - quit normal defrosting
    - turn off by RC
    - Press AUTO/COOL button continuously for 5s again

## 1.10 Timer Function

- Timing range is 24 hours.
- Timer on. The machine will turn on automatically when reaching the setting time.
- Timer off. The machine will turn off automatically when reaching the setting time.
- Timer on/off. The machine will turn on automatically when reaching the setting "on" time, and then turn off automatically when reaching the setting "off" time.
- Timer off/on. The machine will turn off automatically when reaching the setting "off" time, and then turn on automatically when reaching the setting "on" time.
- The timer function will not change the AC current operation mode. Suppose AC is off now, it will not start up firstly after setting the "timer off" function. And when reaching the setting time, the timer LED will be off and the AC running mode has not been changed.
- The setting time is relative time.
- The AC will quit the timer function when it has malfunction

## 1.11 Sleep Function

- The sleep function is available in cooling, heating, or auto mode.
- The operational process for sleep mode is as follows:
  - When cooling, the temperature rises 1°C (to not higher than 30°C) every hour. After 2 hours, the temperature stops rising and the indoor fan is fixed at low speed.
  - When heating, the temperature decreases 1°C (to not lower than 16°C) every hour. After 2 hours, the temperature stops decreasing and the indoor fan is fixed at low speed. Anti-cold wind function takes priority.
- The operating time for sleep mode is 8 hours, after which, the unit exits this mode.
- The timer setting is available in this mode.

## 1.12 Follow Me(Optional)

- If you press "Follow Me" on the remote, the indoor unit will beep. This indicates the follow me function is active.
- Once active, the remote control will send a signal every 3 minutes, with no beeps. The unit automatically sets the temperature according to the measurements from the remote control.

- The unit will only change modes if the information from the remote control makes it necessary, not from the unit's temperature setting.
- If the unit does not receive a signal for 7 minutes or you press "Follow Me," the function turns off. The unit regulates temperature based on its own sensor and settings.

### 1.13 Auto-Restart Function

- The indoor unit has an auto-restart module that allows the unit to restart automatically. The module automatically stores the current settings and, in the case of a sudden power failure, will restore those setting automatically within 3 minutes after power returns.
- If there is a power failure while the unit is running, the compressor starts 3 minutes after the unit restarts. If the unit was already off before the power failure, the unit stands by.

### 1.14 8°C/12°C(46°F/54°F) Heating

- When the air conditioner operates under heating mode with the set temperature of 16°C(60°F) or 20°C(68°F), scrolls through operation mode as follows by pressing Temp Down button twice in one second:
- When AC receives signals, such as switch on/off, Sleeping mode, mode setting, adjusting the set temperature or fan speed, it will quit the this function.

### 1.15 Silence

Press "Silence" on the remote control to enable the SILENCE function. While this function is active, the indoor unit will run at faint breeze(1% fan speed), which reduces noise to the lowest possible level.

### 1.16 Self Clean(Optional)

- The indoor unit will run at low fan for 16 minutes, then turn off, if you press "Self Clean" when the unit is in cooling or drying mode.
- Self Clean keeps the indoor unit dry and prevents mold growth.

### 1.17 ECO Function

- Used to enter the energy efficient mode.
  - Under cooling mode, press ECO button, the remote controller will adjust the temperature automatically to 24°C, fan speed of Auto to save energy (but only if the set temperature is less than 24°C). If the set temperature is more than 24°C and 30°C, press the

ECO button, the fan speed will change to Auto, the set temperature will remain unchanged.

- When AC receives signals, such as switch off, Turbo operation , Silence operation , Self clean operation , Forced cooling operation, mode setting, Sleeping mode, or adjusting the set temperature to less than 24°C, it will quit the ECO operation.
- Operation time in ECO mode is 8 hours. After 8 hours the AC quits this mode.
- When there's any one temperature sensor in malfunction, the AC will quit ECO mode.
- Indoor fan will run at auto fan when enter into the ECO mode .The setting temperature and setting fan speed can be changed through remote controller signal.

### 1.18 Electrical Energy Consumption Control Function

Press the "Gear" button on remote controller to enter the energy efficient mode in a sequence of following:

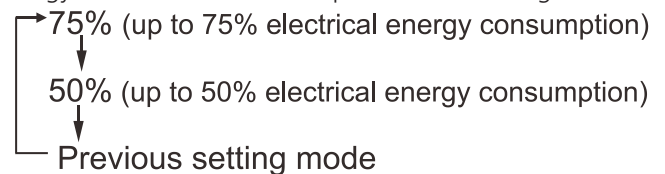

Turn off the unit or activate ECO, sleep, Super cool, Silence or self clean function will quit this function.

### 1.19 Intelligent Eye

With the built-in infrared sensor, the indoor unit detects human movement. The compressor will operate in low frequency if you leave the room for 30 minutes. The compressor will operate in lower frequency if you leave the room for 120 minutes, and resume automatically when you come back, which helps saving more energy.

### 1.20 Wireless Control (Optional)

- Wireless control allows you to control your air conditioner using your mobile phone and a Wireless connection.
- For the USB device access, replacement, maintenance operations must be carried out by professional staff.

## 2. Remote Controller Functions

### 2.1 Infrared Wireless Remote Controller

R51M/E(Standard)

#### Remote Controller Specifications

Model	RG10P(2HS)/BGEF
Rated Voltage	3.0V (Dry batteries R03/LR03×2)
Reaching Distance	8m
Environment Temperature Range	-5°C~60°C(23°F~140°F)

#### Buttons and Functions

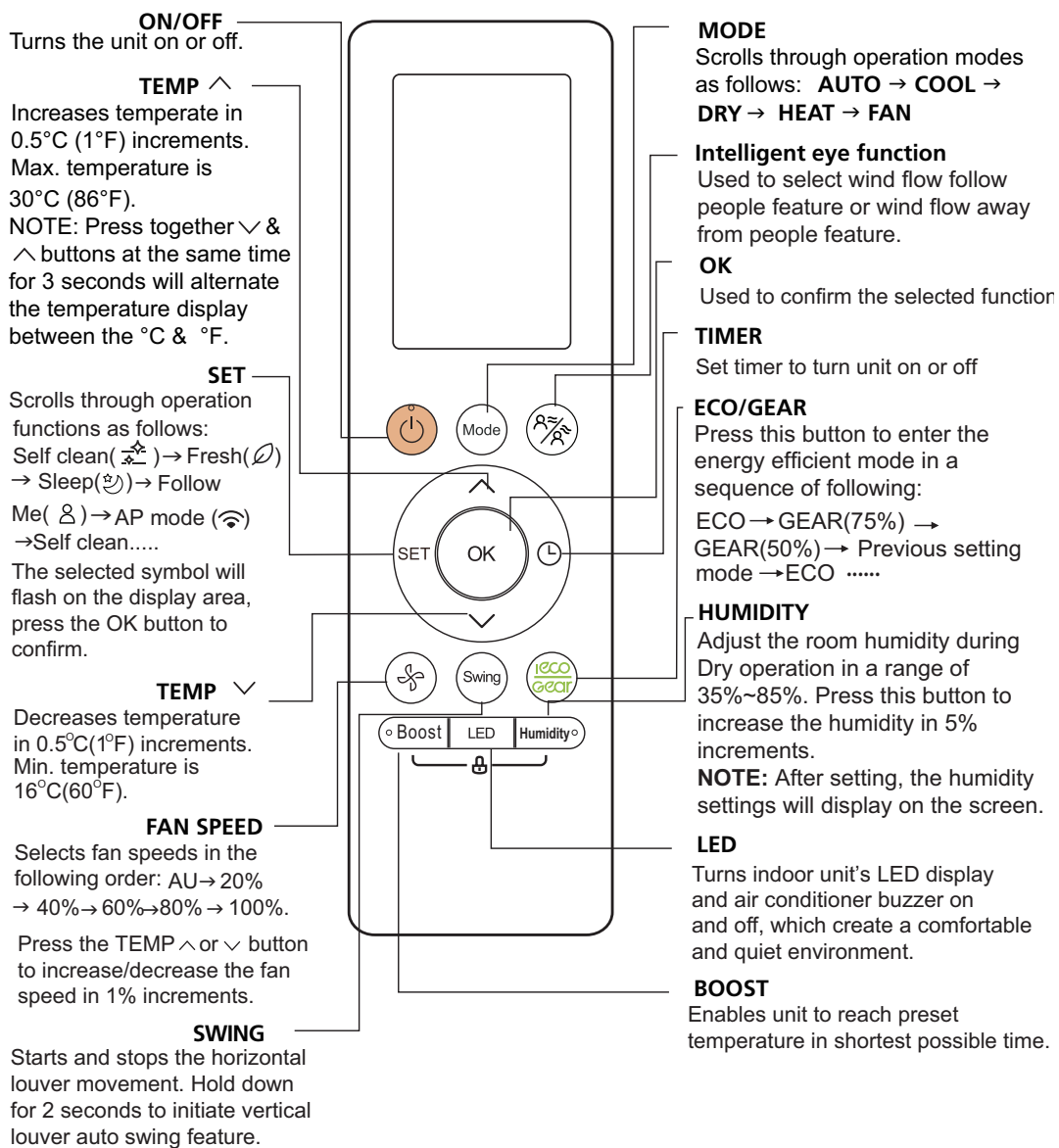

## Remote LCD Screen Indicators

- |  |  |
|--|--|
|  Wind flow follow people      |  Not applicable for this unit               |
|  Wind flow away from people   |  Fresh feature display                      |
|  Not applicable for this unit |  Sleep mode display                         |
|  Not applicable for this unit |  Follow me feature display                  |
|  Not applicable for this unit |  Wireless control feature display           |
|  |  Low battery detection display (If flashes) |

**Transmission Indicator**  
Lights up when remote sends signal to indoor unit



**TIMER ON display**









**TIMER OFF display**



**Silence feature display**

**FAN SPEED display**

Displays selected fan speed:

Silence		1%
LOW		2%-20%
MED		21%-40%
HIGH		41%-60%
		61%-80%
AUTO		81%-100%
		<u>AUTO</u>

This fan speed can not be adjusted in AUTO or DRY mode.

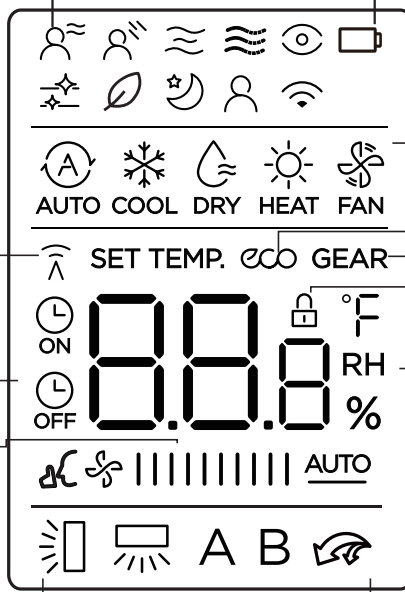

**MODE display**

Displays the current mode, including:



**ECO display**

Displays when ECO feature is activated

**GEAR display**

Displays when GEAR feature is activated

**LOCK display**

Displays when LOCK feature is activated.

**Temperature/Timer/Fan speed display**

Displays the set temperature by default, or fan speed or timer setting when using TIMER ON/OFF functions.

- Temperature range: 16-30°C/60-86°F
- Timer setting range: 0-24 hours
- Fan speed setting range: AU -100%
- Humidity setting range: 35% -85%

This display is blank when operating in FAN mode.



Not applicable for this unit



**Vertical louver auto swing display**



**TURBO mode display**



Not applicable for this unit

## How To Use The Basic Functions

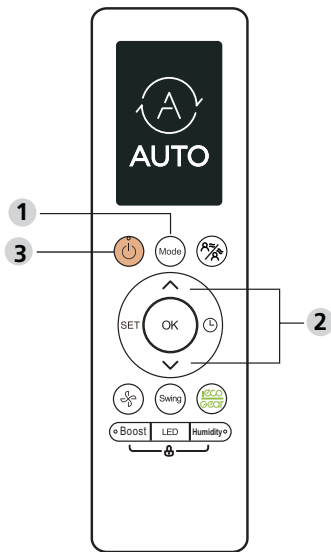

## Setting Temperature

The operating temperature range for units is 16-30°C/60-86°F. You can increase or decrease the set temperature in 0.5°C/1°F increments.

## AUTO Operation

In AUTO mode, the unit will automatically select the COOL, FAN, HEAT or DRY mode based on the set temperature.

1. Press the MODE button to select Auto mode.
2. Set your desired temperature using the Temp ▲ or Temp ▼ button.
3. Press the ON/OFF button to start the unit.

NOTE: FAN SPEED can't be set in Auto mode.

## COOL Operation

1. Press the MODE button to select COOL mode.
2. Set your desired temperature using the Temp ▲ or Temp ▼ button.
3. Press the FAN button to select the fan speed in a range of Au-100%, in conjunction with Temp ▲ or Temp ▼ button.
4. Press the ON/OFF button to start the unit.

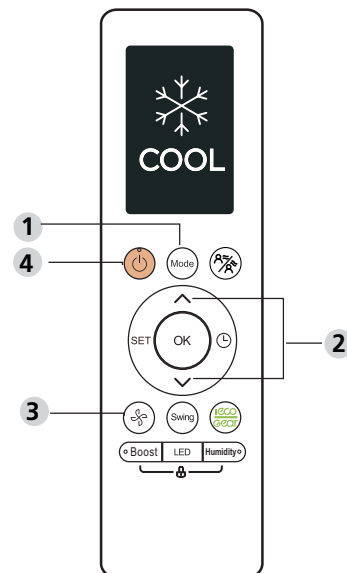
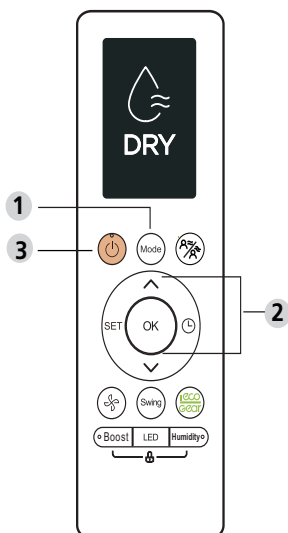

## DRY Operation(dehumidifying)

1. Press the MODE button to select DRY mode.
2. Set your desired temperature using the Temp ▲ or Temp ▼ button.
3. Press the ON/OFF button to start the unit.

NOTE: FAN SPEED can't be changed in DRY mode.

## FAN Operation

1. Press the MODE button to select FAN mode.
2. Press the FAN button to select the fan speed in a range of Au-100%, in conjunction with Temp ▲ or Temp ▼ button.
3. Press the ON/OFF button to start the unit.

NOTE: You can't set temperature in FAN mode. As a result, your remote control sLCD screen will not display temperature.

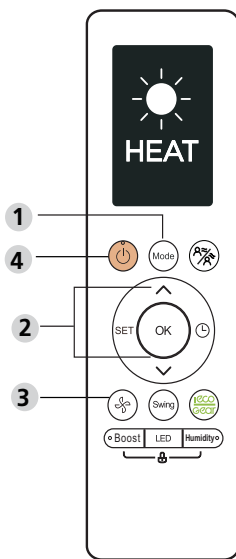
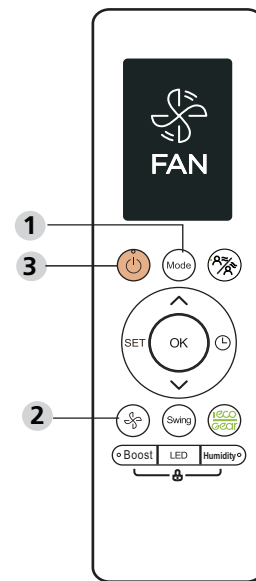



## HEAT Operation

1. Press the MODE button to select HEAT mode.
2. Set your desired temperature using the Temp ▲ or Temp ▼ button.
3. Press the FAN button to select the fan speed in a range of Au-100%, in conjunction with Temp ▲ or Temp ▼ button.
4. Press the ON/OFF button to start the unit.



NOTE: As outdoor temperature drops, the performance of your unit's HEAT function may be affected. In such instances, we recommend using this air conditioner in conjunction with other heating appliance.

## How To Use The Advanced Functions

### SET Function

- Press the SET button to enter the function setting, then press SET button or Temp  or Temp  button to select the desired function. The selected symbol will flash on the display area, press the OK button to confirm.
- To cancel the selected function, just perform the same procedures as above.
- Press the SET button to scroll through operation functions as follows:

Self clean ()--> Fresh\* () --> Sleep() -->

Follow Me()--> AP Mode\*()

[\*]: Model dependent

### ECO/GEAR Function

NOTE: This function is only available under COOL mode.

Press ECO/GEAR button to enter the energy efficient mode in a sequence of following:

ECO -->GEAR(75%) -->GEAR(50%) --> Previous setting mode -->ECO.....

ECO operation:

Under cooling mode, press this button, the remote controller will adjust the temperature automatically to 24°C, fan speed of Auto to save energy(but only if the set temperature is less than 24°C). If the set temperature is above 24°C , press the ECO button, the fan speed will change to Auto, the set temperature will remain unchanged.

NOTE:

- Pressing the ON/OFF button, modifying the mode or adjusting the set temperature to less than 24°C will stop ECO operation.
- Under ECO operation, the set temperature should be 24°C or higher. it may result in insufficient cooling. If you feel uncomfortable, just press the ECO button again to stop it.

GEAR operation:

- Press this button to enter the energy efficient mode in a sequence of following:

75% (up to 75% electrical energy consumption)



50% (up to 50% electrical energy consumption)



Previous setting mode

- This function is only available under COOL mode.
- Under GEAR operation, the display on the remote

controller will alternate between electrical energy consumption and set temperature.

### Intelligent Eye Function()

Under Intelligent eye mode, with the built-in infrared sensor, the unit can detect the people's activities in the room. The wind can flow away from people, but also can follow people. In Cooling mode, when you are away for 30 minutes, the unit automatically lowers the frequency to save energy(for inverter models only). And the unit will automatically resume operation if sensing human activity again.

### Silence Function

Hold down Fan button for more than 2 seconds to activate/cancel Silent mode.

### FP Function

The unit will operate at high fan speed (while compressor on) with temperature automatically set to 8°C(46°F)/12°C(54°F), pressing  button twice in one seconds under HEAT Mode and setting temperature of 16°C(60°F) heating. The indoor unit display shows "FP".

Press On/Off, Sleep, Mode, Fan and Temp. button while operating will cancel this function.

### Lock Function

Press together Boost button and Humidity button at the same time more than 5 seconds to activate Lock function.

All buttons will not response except pressing these two buttons for two seconds again to disable locking.

### Boost Function()

When you select Boost feature in COOL mode, the unit will blow cool air with strongest wind setting to jump-start the cooling process.

When you select Boost feature in HEAT mode, for units with Electric heat elements, the Electric HEATER will activate and jump-start the heating process.

### Swing Button

- The horizontal louver will swing up and down automatically when pressing Swing button. Press again to make it stop.
- Hold down the Swing button for 2 seconds will start or stop the vertical louver auto swing feature.

### LED Display

- Press this button to turn on and turn off the display on the indoor unit.
- Keep pressing this button more than 5 seconds, the indoor unit will display the actual room temperature. Press more than 5 seconds again will revert back to display the setting temperature.







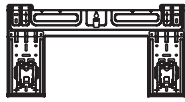

---

# Installation

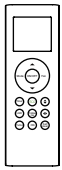
## Contents

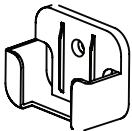
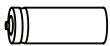
Accessories .....	31
1. Installation Summary-Indoor Unit.....	32
2. Location Selection .....	33
3. Indoor Unit Installation .....	34
4. Outdoor Unit Installation.....	39
5. Refrigerant Pipe Installation.....	40
6. Vacuum Drying and Leakage Checking.....	41
7. Additional Refrigerant Charge .....	42
8. Electrical and Gas Leak Checks .....	43
9. Test Operation .....	43

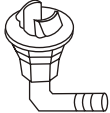
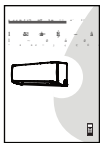
## Accessories

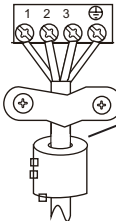
Name	Shape	Quantity	
Mounting plate		1	
Clip anchor		5~8(depending on models)	
Mounting plate fixing screw ST3.9 X 25		5~8(depending on models)	
Remote controller		1	
Fixing screw for remote controller holder ST2.9 x 10		2	
Remote controller holder		1	
Dry battery AAA.LR03		2	
Seal		1(for cooling & heating models only)	
Drain joint			
Manual		2~3	
Small Filter(Need to be installed on the back of main air filter by the authorized technician while installing the machine)		1~2(depending on models)	
Connecting pipe assembly	Liquid side	Φ6.35 (1/4in)	Parts you must purchase. Consult the dealer about the pipe size.
		Φ9.52 (3/8in)	
	Gas side	Φ9.52 (3/8in)	
		Φ12.7 (1/2in)	
		Φ16 (5/8in)	
Φ19 (3/4in)			
Magnetic ring and belt(if supplied ,please refer to the wiring diagram to install it on the connective cable. )	 Pass the belt through the hole of the Magnetic ring to fix it on the cable	Varies by models	

# 1. Installation Summary-Indoor unit

## Installation Order

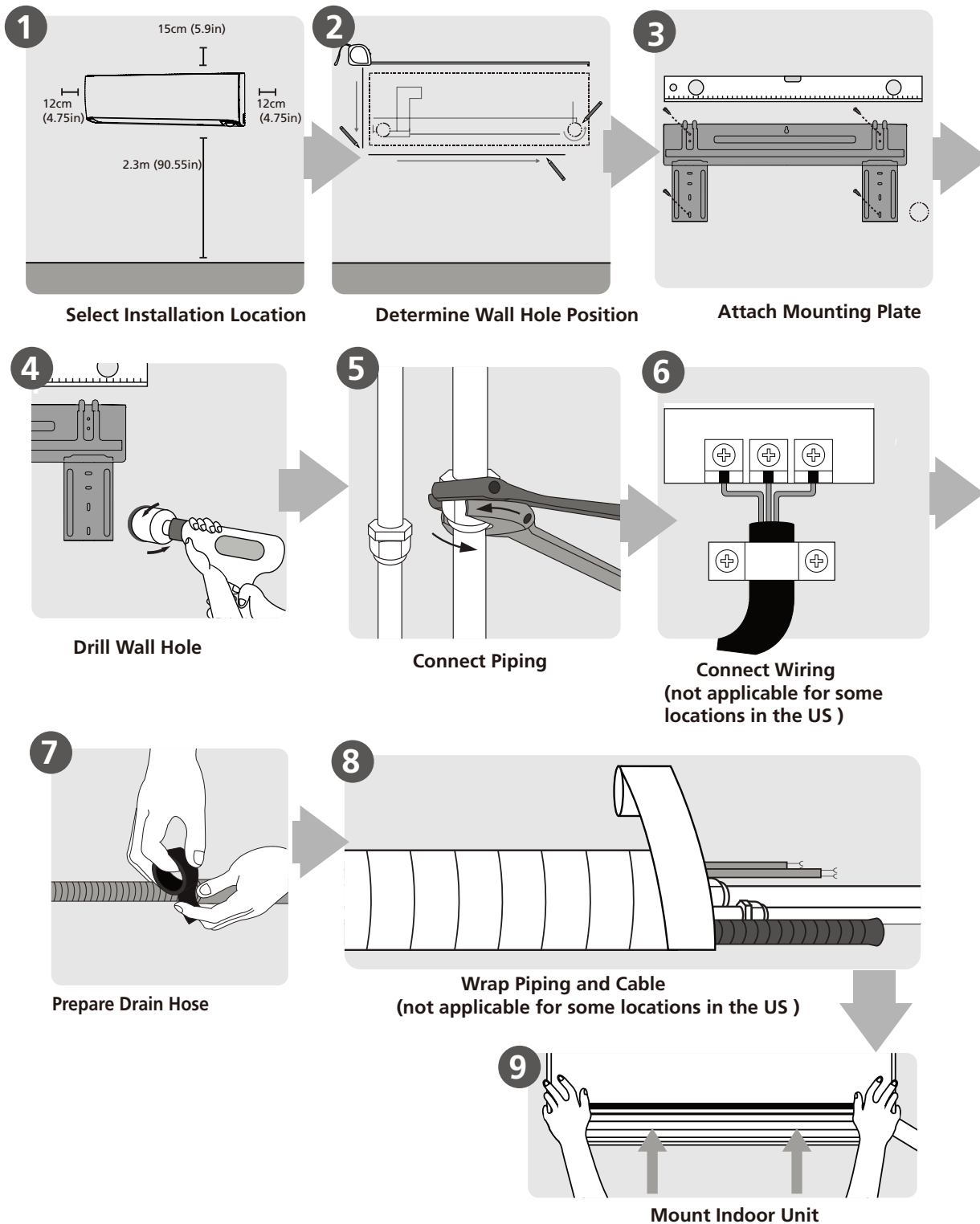

## 2. Location selection

2.1 Unit location selection can refer to installation manual.

2.2 **DO NOT** install the unit in the following locations:

- Where oil drilling or fracking is taking place.
- Coastal areas with high salt content in the air.
- Areas with caustic gases in the air, such as near hot springs.
- Areas with power fluctuations, such as factories.
- Enclosed spaces, such as cabinets.
- Areas with strong electromagnetic waves.
- Areas that store flammable materials or gas.
- Rooms with high humidity, such as bathrooms or laundry rooms.
- If possible, **DO NOT** install the unit where it is exposed to direct sunlight.

2.3 **The minimum distance between the outdoor unit and walls described in the installation guide does not apply to airtight rooms. Be sure to keep the unit unobstructed in at least two of the three directions (M, N, P)**

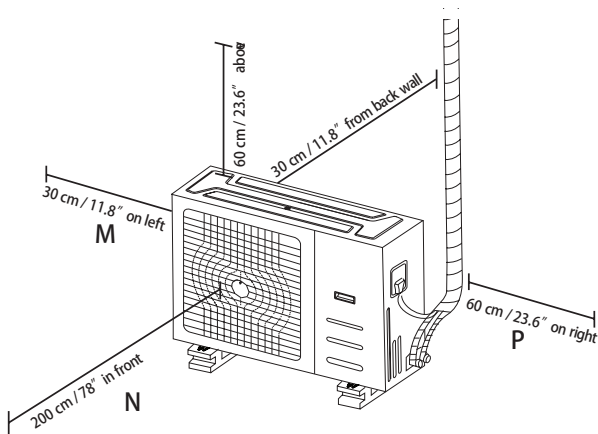

## 2.4 Rows of series installation

The relations between H, A and L are as follows.

	L	A
L ≤ H	$L \leq 1/2H$	25 cm / 9.8" or more
	$1/2H < L \leq H$	30 cm / 11.8" or more
L > H	Can not be installed	

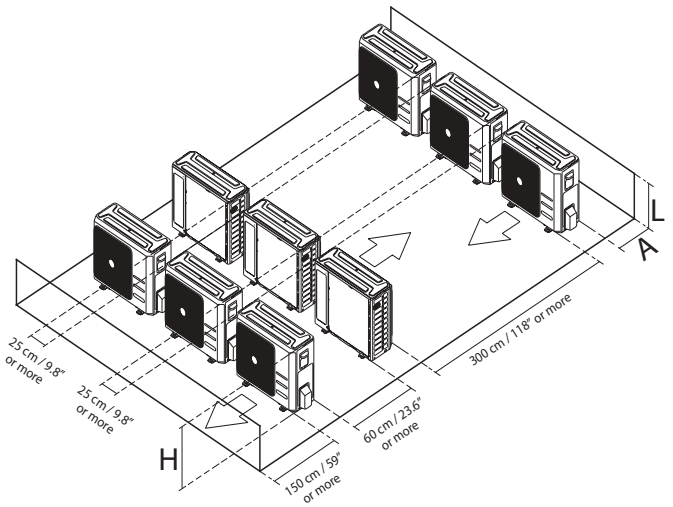

DO NOT install the rows of series like following figure.

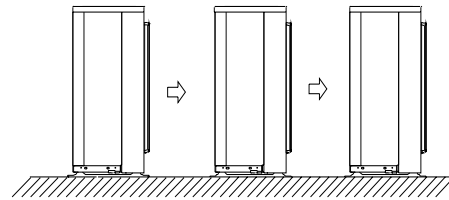

## 2.5 If the unit is exposed to heavy wind:

- Install unit so that air outlet fan is at a 90° angle to the direction of the wind. If needed, build a barrier in front of the unit to protect it from extremely heavy winds.

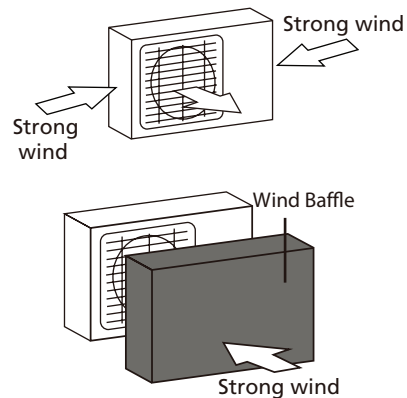

## 2.6 If the unit is frequently exposed to heavy rain or snow:

Build a shelter above the unit to protect it from the rain or snow. Be careful not to obstruct air flow around the unit.

## 2.7 If the unit is frequently exposed to salty air (seaside):

Use outdoor unit that is specially designed to resist corrosion.

### 3. Indoor Unit Installation IH2-Y 27M-35M

#### 3.1 Service space for indoor unit

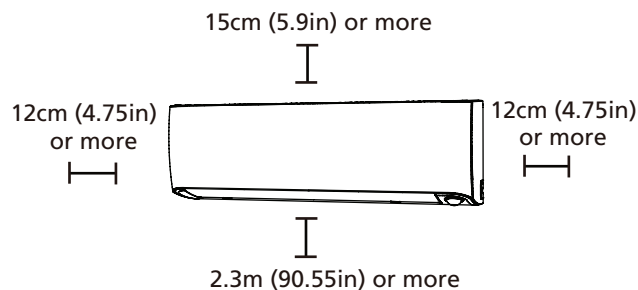

#### 3.2 Attach mounting plate to wall

- **The mounting plate is the device on which you will mount the indoor unit.**

1. Remove the screw that attaches the mounting plate to the back of the indoor unit.
2. Place the mounting plate against the wall in a location that meets the standards in the Select Installation Location step. (See Mounting Plate Dimensions for detailed information on mounting plate sizes.)
3. Drill holes for mounting screws in places that:
  - have studs and can support the weight of the unit.
  - correspond to screw holes in the mounting plate.
4. Secure the mounting plate to the wall with the screws provided.
5. Make sure that mounting plate is flat against the wall.

- **Mounting plate dimensions**

Different models have different mounting plates. In order to ensure that you have ample room to mount the indoor unit, the diagrams to the right show different types of mounting plates along with the following dimensions:

1. Width of mounting plate
2. Height of mounting plate
3. Width of indoor unit relative to plate
4. Height of indoor unit relative to plate
5. Recommended position of wall hole (both to the left and right of mounting plate)
6. Relative distances between screw holes

### Correct orientation of Mounting Plate

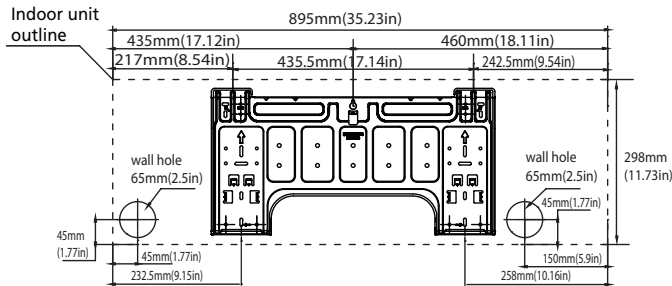
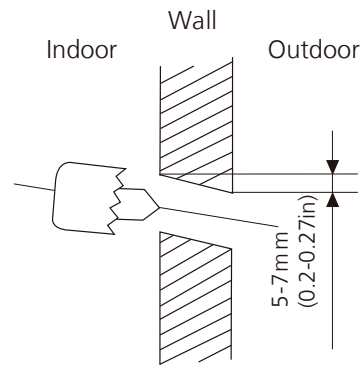
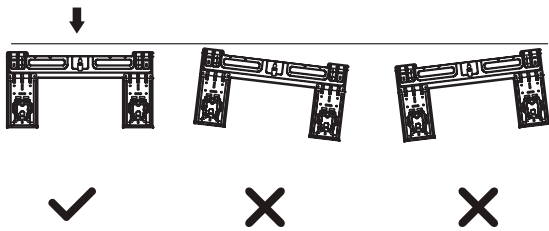

A

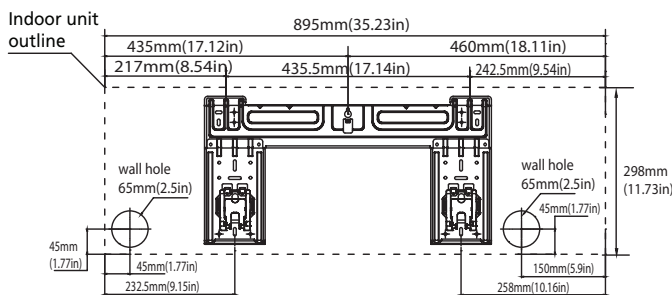

B

### 3.4 Prepare refrigerant piping

The refrigerant piping is inside an insulating sleeve attached to the back of the unit. You must prepare the piping before passing it through the hole in the wall.

1. Based on the position of the wall hole relative to the mounting plate, choose the side from which the piping will exit the unit.
2. If the wall hole is behind the unit, keep the knock-out panel in place. If the wall hole is to the side of the indoor unit, remove the plastic knock-out panel from that side of the unit.



Knock-out Panel

### 3.3 Drill wall hole for connective piping

You must drill a hole in the wall for refrigerant piping, the drainage pipe, and the signal cable that will connect the indoor and outdoor units.

1. Determine the location of the wall hole based on the position of the mounting plate. Refer to Mounting Plate Dimensions.
2. Using a 65mm (2.5in) or 90mm(3.54in) (depending on models) core drill, drill a hole in the wall. Make sure that the hole is drilled at a slight downward angle, so that the outdoor end of the hole is lower than the indoor end by about 5mm to 7mm (0.2-0.27in). This will ensure proper water drainage.
3. Place the protective wall cuff in the hole. This protects the edges of the hole and will help seal it when you finish the installation process.

**NOTE:** When drilling the wall hole, make sure to avoid wires, plumbing, and other sensitive components.

3. If existing connective piping is already embedded in the wall, proceed directly to the Connect Drain Hose step. If there is no embedded piping, connect the indoor unit's refrigerant piping to the connective piping that will join the indoor and outdoor units. Refer to the Refrigerant Piping Connection section of this manual for detailed instructions.

**NOTE:** Refrigerant piping can exit the indoor unit from four different angles:

- Left-hand side
- Left rear
- Right-hand side
- Right rear

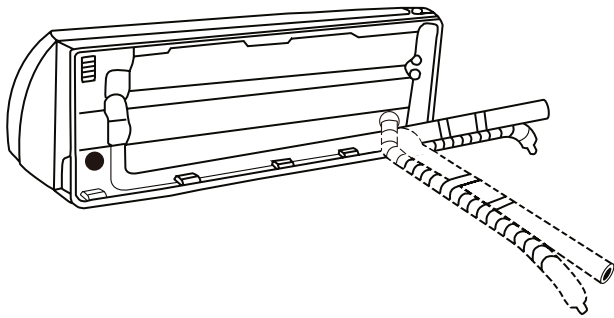
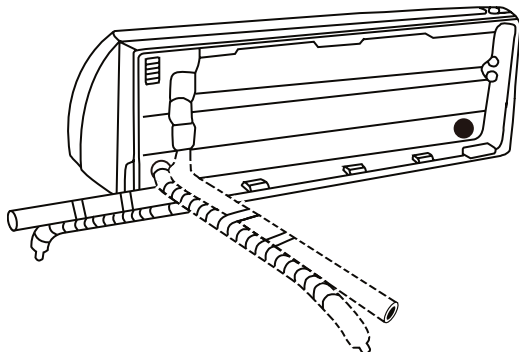

Be extremely careful not to dent or damage the piping while bending them away from the unit. Any dents in the piping will affect the unit's performance.

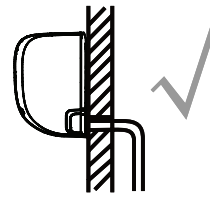

**CORRECT**

Make sure there are no kinks or dent in drain hose to ensure proper drainage.

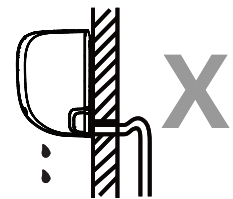

**NOT CORRECT**

Kinks in the drain hose will create water traps.

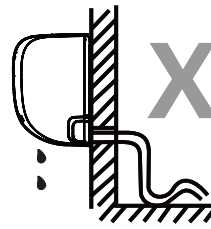

**NOT CORRECT**

Kinks in the drain hose will create water traps.

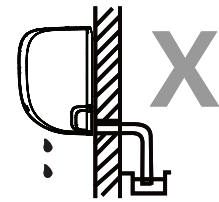

**NOT CORRECT**

Do not place the end of the drain hose in water or in containers that collect water. This will prevent proper drainage.

#### PLUG THE UNUSED DRAIN HOLE

To prevent unwanted leaks you must plug the unused drain hole with the rubber plug provided.

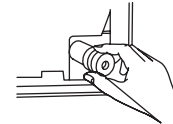

### 3.5 Connect drain hose

By default, the drain hose is attached to the left hand side of unit (when you're facing the back of the unit).

- Wrap the connection point firmly with Teflon tape to ensure a good seal and to prevent leaks.
- Remove the air filter and pour a small amount of water into the drain pan to make sure that water flows from the unit smoothly.

#### NOTE ON DRAIN HOSE PLACEMENT:

- Make sure to arrange the drain hose according to the following figures.

## 3.6 Connect signal and power cable

### 3.6.1 Before performing electrical work, read these regulations

1. All wiring must comply with local and national electrical codes, and must be installed by a licensed electrician.
2. All electrical connections must be made according to the Electrical Connection Diagram located on the panels of the indoor and outdoor units.
3. If there is a serious safety issue with the power supply, stop work immediately. Explain your reasoning to the client, and refuse to install the unit until the safety issue is properly resolved.
4. Power voltage should be within 90-110% of rated voltage. Insufficient power supply can cause malfunction, electrical shock, or fire.
5. If connecting power to fixed wiring, install a surge protector and main power switch with a capacity of 1.5 times the maximum current of the unit.
6. If connecting power to fixed wiring, a switch or circuit breaker that disconnects all poles and has a contact separation of at least 1/8in (3mm) must be incorporated in the fixed wiring. The qualified technician must use an approved circuit breaker or switch.
7. Only connect the unit to an individual branch circuit outlet. Do not connect another appliance to that outlet.
8. Make sure to properly ground the air conditioner.
9. Every wire must be firmly connected. Loose wiring can cause the terminal to overheat, resulting in product malfunction and possible fire.
10. Do not let wires touch or rest against refrigerant tubing, the compressor, or any moving parts within the unit.
11. If the unit has an auxiliary electric heater, it must be installed at least 1 meter (40in) away from any combustible materials.
12. BEFORE PERFORMING ANY ELECTRICAL OR WIRING WORK, TURN OFF THE MAIN POWER TO THE SYSTEM.

### 3.6.2 Connect signal and power cable

The signal cable enables communication between the indoor and outdoor units. You must first choose the right cable size before preparing it for connection.

Cable Types:

- Indoor Power Cable (if applicable): H05VV-F or H05V2V2-F
- Outdoor Power Cable: H07RN-F

- Signal Cable: H07RN-F

Table: Minimum Cross-Sectional Area of Power and Signal Cables

Rated Current of Appliance (A)	Nominal Cross-Sectional Area (mm <sup>2</sup> )
> 3 and ≤ 6	0.75
> 6 and ≤ 10	1
> 10 and ≤ 16	1.5
> 16 and ≤ 25	2.5
> 25 and ≤ 32	4
> 32 and ≤ 40	6

1. Prepare the cable for connection:
  - Using wire strippers, strip the rubber jacket from both ends of signal cable to reveal about 40mm (1.57in) of the wires inside.
  - Strip the insulation from the ends of the wires.
  - Using wire crimper, crimp u-type lugs on the ends of the wires.
2. Open front panel of the indoor unit.
3. Using a screwdriver, open the wire box cover on the right side of the unit, then open the terminal block cover. This will reveal the terminal block.

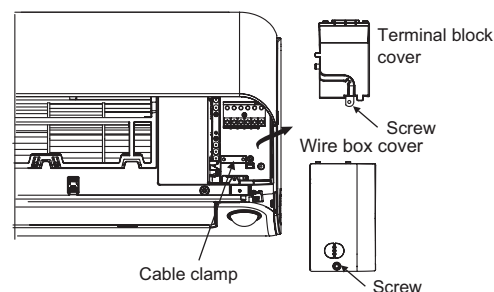

4. Unscrew the cable clamp below the terminal block and place it to the side.
5. Facing the back of the unit, remove the plastic panel on the bottom left-hand side.
6. Feed the signal wire through this slot, from the back of the unit to the front.
7. Facing the front of the unit, match the wire colors with the labels on the terminal block, connect the u-lug and firmly screw each wire to its corresponding terminal.
8. After checking to make sure every connection is secure, use the cable clamp to fasten the signal cable to the unit. Screw the cable clamp down tightly.
9. Replace the wire cover on the front of the unit, and the plastic panel on the back.

**NOTE:**

- Choose the right cable size

The size of the power supply cable, signal cable, fuse, and switch needed is determined by the maximum current of the unit. The maximum current is indicated on the nameplate located on the side panel of the unit. Refer to this nameplate to choose the right cable, fuse, or switch.

- Take note of fuse specifications

The air conditioner's circuit board (PCB) is designed with a fuse to provide overcurrent protection. The specifications of the fuse are printed on the circuit board, such as: T3.15A/250VAC, T5A/250VAC, etc.

- Pay attention to live wire

While crimping wires, make sure you clearly distinguish the Live ("L") Wire from other wires.

- All wiring must be performed strictly in accordance with the wiring diagram located on the back of the indoor unit's front panel.
- Do not mix up live and null wires.

This is dangerous, and can cause the air conditioning unit to malfunction.

- The wiring connection process may differ slightly between units.

### 3.7 Wrap piping and cables

Before passing the piping, drain hose, and the signal cable through the wall hole, you must bundle them together to save space, protect them, and insulate them.

1. Bundle the drain hose, refrigerant pipes, and signal cable according to the picture below:

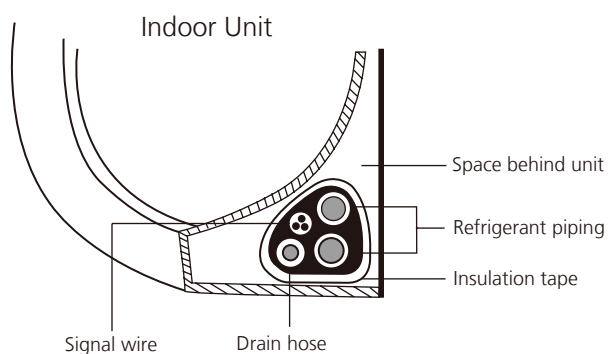

2. Using adhesive vinyl tape, attach the drain hose to the underside of the refrigerant pipes.
3. Using insulation tape, wrap the signal wire, refrigerant pipes, and drain hose tightly together. Double-check that all items are bundled in accordance with the picture above.

**NOTE:**

- Drain hose must be on bottom

Make sure that the drain hose is at the bottom of the bundle. Putting the drain hose at the top of the bundle can cause the drain pan to overflow, which can lead to fire or water damage.

- Do not intertwine signal cable with other wires

While bundling these items together, do not intertwine or cross the signal cable with any other wiring

- Do not wrap ends of piping

When wrapping the bundle, keep the ends of the piping unwrapped. You need to access them to test for leaks at the end of the installation process.

## 3.8 Mount indoor unit

### 3.8.1 If you installed new connective piping to the outdoor unit, do the following:

1. If you have already passed the refrigerant piping through the hole in the wall, proceed to **Prepare refrigerant piping**.
2. Otherwise, double-check that the ends of the refrigerant pipes are sealed to prevent dirt or foreign materials from entering the pipes.
3. Slowly pass the wrapped bundle of refrigerant pipes, drain hose, and signal wire through the hole in the wall.
4. Hook the top of the indoor unit on the upper hook of the mounting plate.
5. Check that unit is hooked firmly on mounting by applying slight pressure to the left and right-hand sides of the unit. The unit should not jiggle or shift.
6. Using even pressure, push down on the bottom half of the unit. Keep pushing down until the unit snaps onto the hooks along the bottom of the mounting plate.
7. Again, check that the unit is firmly mounted by applying slight pressure to the left and the right-hand sides of the unit.

### 3.8.2 If refrigerant piping is already embedded in the wall, do the following:

1. Hook the top of the indoor unit on the upper hook of the mounting plate.
2. Use the holder in the mounting plate to prop up the unit, giving you enough room to connect the refrigerant piping, signal cable, and drain hose.

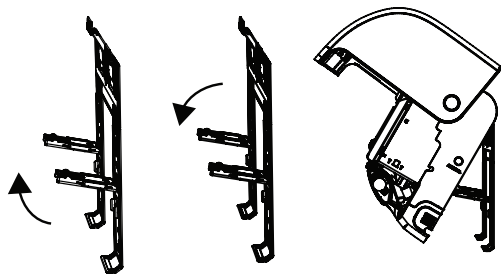

3. Connect drain hose and refrigerant piping (refer to Refrigerant Piping Connection section of this manual for instructions).

4. Keep pipe connection point exposed to perform the leak test (refer to Electrical Checks and Leak Checks section of this manual).

5. After the leak test, wrap the connection point with insulation tape.

6. Remove the bracket or wedge that is propping up the unit.

7. Using even pressure, push down on the bottom half of the unit. Keep pushing down until the unit snaps onto the hooks along the bottom of the mounting plate.

**NOTE:**

- Unit is adjustable

Keep in mind that the hooks on the mounting plate are smaller than the holes on the back of the unit. If you find that you don't have ample room to connect embedded pipes to the indoor unit, the unit can be adjusted left or right by about 30-50mm (1.25-1.95in), depending on the model.

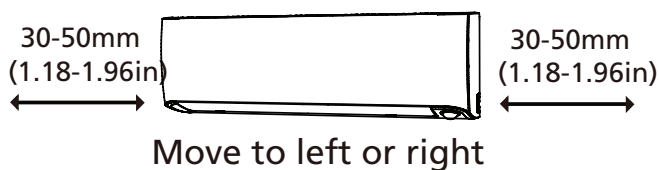

## 4. Outdoor unit installation(Side Discharge Unit)

### 4.1 Service space for outdoor unit

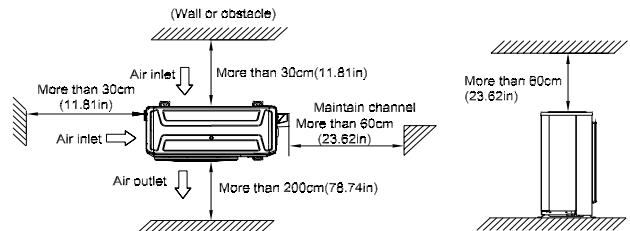

### 4.2 Bolt pitch

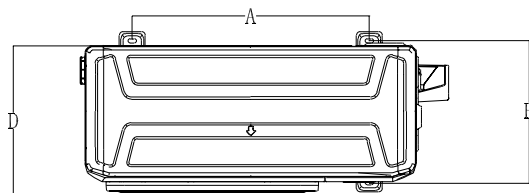

Size	unit	A	B	D
MH2-Y 27M-35M	mm	511	317	330
	inch	20.12	12.48	12.99

### 4.3 Install Outdoor Unit

#### Fix the outdoor unit with anchor bolts(M10)

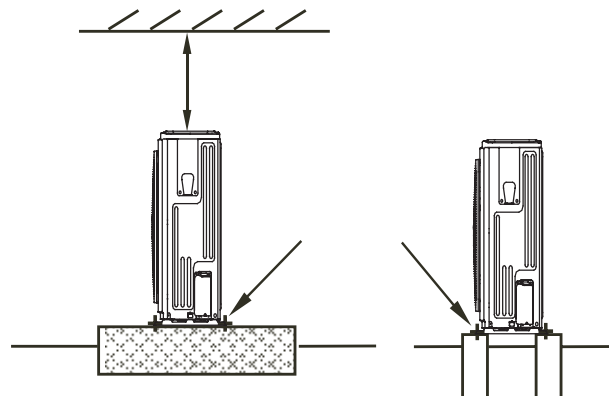

#### Cation

Since the gravity center of the unit is not at its physical center, so please be careful when lifting it with a sling.

Never hold the inlet of the outdoor unit to prevent it from deforming.

Do not touch the fan with hands or other objects.

Do not lean it more than 45°, and do not lay it sidelong.

Make concrete foundation according to the specifications of the outdoor units.

Fasten the feet of this unit with bolts firmly to prevent it from collapsing in case of earthquake or strong wind.

#### 4.4 Install drain joint

Heat pump units require a drain joint. Before bolting the outdoor unit in place, you must install the drain joint at the bottom of the unit. Note that there are two different types of drain joints depending on the type of outdoor unit.

• **If the drain joint comes with a rubber seal (see Fig. A), do the following:**

1. Fit the rubber seal on the end of the drain joint that will connect to the outdoor unit.
2. Insert the drain joint into the hole in the base pan of the unit.
3. Rotate the drain joint 90° until it clicks in place facing the front of the unit.
4. Connect a drain hose extension (not included) to the drain joint to redirect water from the unit during heating mode.

• **If the drain joint doesn't come with a rubber seal (see Fig. B), do the following:**

1. Insert the drain joint into the hole in the base pan of the unit. The drain joint will click in place.
2. Connect a drain hose extension (not included) to the drain joint to redirect water from the unit during heating mode.

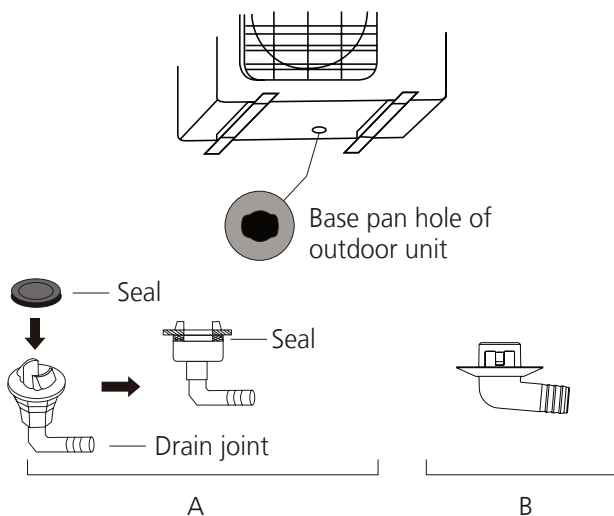

## 5. Refrigerant Pipe Installation

### 5.1 Maximum length and drop height

Ensure that the length of the refrigerant pipe, the number of bends, and the drop height between the indoor and outdoor units meets the requirements shown in the following table.

Size	Max. Length (m/ft)	Max. Elevation (m/ft)
27M-35M	25/82	10/33

**caution:**

- The capacity test is based on the standard length and the maximum permissible length is based on the system reliability.
- Oil traps

If the indoor unit is installed higher than the outdoor unit:

-If oil flows back into the outdoor unit's compressor, this might cause liquid compression or deterioration of oil return. Oil traps in the rising gas piping can prevent this.

An oil trap should be installed every 10m(32.8ft) of vertical suction line riser.

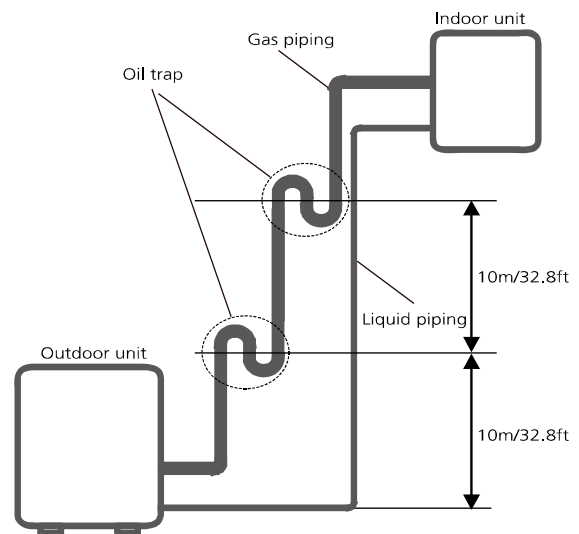

The indoor unit is installed higher than the outdoor unit

If the outdoor unit is installed higher than the indoor unit:

-It is recommended that vertical suction risers not be upsized. Proper oil return to the compressor should be maintained with suction gas velocity. If velocities drop below 7.62m/s(1500fpm (feet per minute)), oil return will be decreased. An oil trap should be installed every 6m(20ft) of vertical suction line riser.

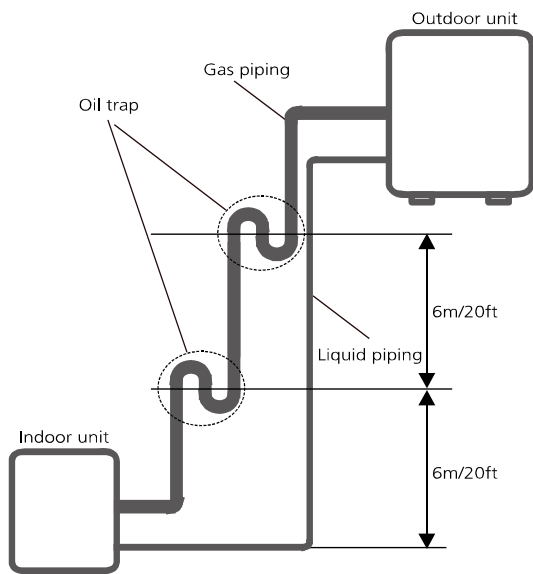

The outdoor unit is installed higher than the indoor unit.

## 5.2 The procedure of connecting pipes

1. Choose the pipe size according to the specification table.
2. Confirm the cross way of the pipes.
3. Measure the necessary pipe length.

4. Cut the selected pipe with pipe cutter
  - Make the section flat and smooth.

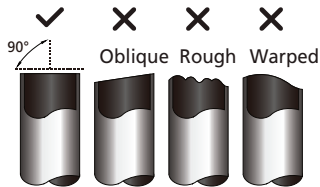

5. Insulate the copper pipe
  - Before test operation, the joint parts should not be heat insulated.
6. Flare the pipe
  - Insert a flare nut into the pipe before flaring the pipe
  - According to the following table to flare the pipe.

Outer diameter of pipe (inch(mm))	A (mm/inch)	
	Min	Max
1/4" (6.35)	0.7/0.0275	1.3/0.05
3/8" (9.52)	1.0/0.04	1.6/0.063
1/2" (12.7)	1.0/0.04	1.8/0.07
5/8" (15.9)	2.0/0.078	2.2/0.086

3/4" (19)	2.0/0.078	2.4/0.094
-----------	-----------	-----------

- After flared the pipe, the opening part must be seal by end cover or adhesive tape to avoid duct or exogenous impurity come into the pipe.
7. Drill holes if the pipes need to pass the wall.
  8. According to the field condition to bend the pipes so that it can pass the wall smoothly.
  9. Bind and wrap the wire together with the insulated pipe if necessary.
  10. Set the wall conduit
  11. Set the supporter for the pipe.
  12. Locate the pipe and fix it by supporter
    - For horizontal refrigerant pipe, the distance between supporters should not be exceed 1m.
    - For vertical refrigerant pipe, the distance between supporters should not be exceed 1.5m.
  13. Connect the pipe to indoor unit and outdoor unit by using two spanners.
    - Be sure to use two spanners and proper torque to fasten the nut, too large torque will damage the bellmouthing, and too small torque may cause leakage. Refer the following table for different pipe connection.

Pipe Diameter	Torque	Sketch map
	N.m(lb.ft)	
1/4" (6.35)	15~16 (11~11.8)	
3/8" (9.52)	25~26 (18.4~19.18)	
1/2" (12.7)	35~36 (25.8~26.55)	
5/8" (15.9)	45~47 (33.19~34.67)	
3/4" (19)	65~67	
	(47.94~49.42)	

## 6. Vacuum Drying and Leakage Checking

### 6.1 Purpose of vacuum drying

- Eliminating moisture in system to prevent the phenomena of ice-blockage and copper oxidation.

Ice-blockage shall cause abnormal operation of system, while copper oxide shall damage compressor.

- Eliminating the non-condensable gas (air) in system to prevent the components oxidizing, pressure fluctuation and bad heat exchange during the operation of system.

### 6.2 Selection of vacuum pump

- The ultimate vacuum degree of vacuum pump shall be -756mmHg or above.
- Precision of vacuum pump shall reach 0.02mmHg or above.

### 6.3 Operation procedure for vacuum drying

Due to different construction environment, two kinds of vacuum drying ways could be chosen, namely ordinary vacuum drying and special vacuum drying.

#### 6.3.1 Ordinary vacuum drying

1. When conduct first vacuum drying, connect pressure gauge to the infusing mouth of gas pipe and liquid pipe, and keep vacuum pump running for 1 hour (vacuum degree of vacuum pump shall be reached -755mmHg).
2. If the vacuum degree of vacuum pump could not reach -755mmHg after 1 hour of drying, it indicates that there is moisture or leakage in pipeline system and need to go on with drying for half an hour.
3. If the vacuum degree of vacuum pump still could not reach -755mmHg after 1.5 hours of drying, check whether there is leakage source.
4. Leakage test: After the vacuum degree reaches -755mmHg, stop vacuum drying and keep the pressure for 1 hour. If the indicator of vacuum gauge does not go up, it is qualified. If going up, it indicates that there is moisture or leak source.

#### 6.3.2 Special vacuum drying

The special vacuum drying method shall be adopted when:

1. Finding moisture during flushing refrigerant pipe.
2. Conducting construction on rainy day, because rain

water might penetrated into pipeline.

3. Construction period is long, and rain water might penetrated into pipeline.
4. Rain water might penetrate into pipeline during construction.

Procedures of special vacuum drying are as follows:

1. Vacuum drying for 1 hour.
2. Vacuum damage, filling nitrogen to reach 0.5Kgf/cm<sup>2</sup>.

Because nitrogen is dry gas, vacuum damage could achieve the effect of vacuum drying, but this method could not achieve drying thoroughly when there is too much moisture. Therefore, special attention shall be drawn to prevent the entering of water and the formation of condensate water.

3. Vacuum drying again for half an hour.

If the pressure reached -755mmHg, start to pressure leakage test. If it cannot reached the value, repeat vacuum damage and vacuum drying again for 1 hour.

4. Leakage test: After the vacuum degree reaches -755mmHg, stop vacuum drying and keep the pressure for 1 hour. If the indicator of vacuum gauge does not go up, it is qualified. If going up, it indicates that there is moisture or leak source.

## 7. Additional Refrigerant Charge

- After the vacuum drying process is carried out, the additional refrigerant charge process need to be performed.
- The outdoor unit is factory charged with refrigerant. The additional refrigerant charge volume is decided by the diameter and length of the liquid pipe between indoor and outdoor unit. Refer the following formula to calculate the charge volume.

Diameter of liquid pipe (mm)	Formula
6.35	$V=12g/m \times (L-5)$
9.52	$V=24g/m \times (L-5)$

**V:** Additional refrigerant charge volume (g).

**L :** The length of the liquid pipe (m).

Note:

- Refrigerant may only be charged after performed the vacuum drying process.
- Always use gloves and glasses to protect your hands and eyes during the charge work.
- Use electronic scale or fluid infusion apparatus to weight refrigerant to be recharged. Be sure to avoid extra refrigerant charged, it may cause liquid hammer of the compressor or protections.
- Use supplementing flexible pipe to connect refrigerant cylinder, pressure gauge and outdoor unit. And The refrigerant should be charged in liquid state. Before recharging, The air in the flexible pipe and manifold gauge should be exhausted.
- After finished refrigerant recharge process, check whether there is refrigerant leakage at the connection joint part.(Using gas leakage detector or soap water to detect).

## 8. Electrical and Gas Leak Checks

### 8.1 Electrical Safety Checks

After installation, confirm that all electrical wiring is installed in accordance with local and national regulations, and according to the Installation Manual.

#### 8.1.1 Before test run

- **Check Grounding Work**

Measure grounding resistance by visual detection and with grounding resistance tester. Grounding resistance must be less than 0.1  $\Omega$ .

**Note:** This may not be required for some locations in the US.

#### 8.1.2 During test run

- **Check for Electrical Leakage**

During the Test Run, use an electroprobe and multimeter to perform a comprehensive electrical leakage test.

If electrical leakage is detected, turn off the unit immediately and call a licensed electrician to find and resolve the cause of the leakage.

**Note:** This may not be required for some locations in the US.

### 8.2 Gas Leak Checks

There are two different methods to check for gas leaks.

- **Soap and Water Method**

Using a soft brush, apply soapy water or liquid detergent to all pipe connection points on the indoor unit and outdoor unit. The presence of bubbles indicates a leak.

- **Leak Detector Method**

If using leak detector, refer to the device's operation manual for proper usage instructions.

### 8.3 After performing gas leak checks

After confirming that the all pipe connection points DO NOT leak, replace the valve cover on the outside unit.

---

## 9. Test Operation

### 9.1 Before test run:

Only perform test run after you have completed the following steps:

- Electrical Safety Checks – Confirm that the unit's electrical system is safe and operating properly
- Gas Leak Checks – Check all flare nut connections and confirm that the system is not leaking
- Confirm that gas and liquid (high and low pressure) valves are fully open

### 9.2 Test Run Instructions

You should perform the Test Run for at least 30 minutes.

1. Connect power to the unit.
2. Press the ON/OFF button on the remote controller to turn it on.
3. Press the MODE button to scroll through the following functions, one at a time:
  - COOL – Select lowest possible temperature
  - HEAT – Select highest possible temperature
4. Let each function run for 5 minutes, and perform the following checks:

List of Checks to Perform	PASS/FALL	
No electrical leakage		
Unit is properly grounded		
All electrical terminals properly covered		
Indoor and outdoor units are solidly installed		
All pipe connection points do not leak	Outdoor(2)	Outdoor(2)
Water drains properly from drain hose		
All piping is properly insulated		
Unit performs COOL function properly		
Unit performs HEAT function properly		
Indoor unit louvers rotate properly		





**MideaGroup**  
*humanizing technology*

**CLIVET S.p.A.**

Via Camp Lonc 25, Z.I. Villapaiera  
32032 Feltre (BL) - Italy  
Tel. +39 0439 3131 - info@clivet.it

**CLIVET GMBH**

Hummelsbütteler Steindamm 84,  
22851 Norderstedt, Germany  
Tel. +49 40 325957-0 - info.de@clivet.com

**Clivet Group UK LTD**

Units F5 & F6 Railway Triangle,  
Portsmouth, Hampshire PO6 1TG  
Tel. +44 02392 381235 -  
Enquiries@Clivetgroup.co.uk

**CLIVET LLC**

Office 508-511, Elektrozavodskaya st. 24,  
Moscow, Russian Federation, 107023  
Tel. +7495 6462009 - info.ru@clivet.com

**CLIVET MIDEAST FZCO**

Dubai Silicon Oasis (DSO), High Bay Complex,  
Office N. 20, PO BOX 342009, Dubai, UAE  
Tel. +9714 3208499 - info@clivet.ae

**Clivet South East Europe**

Jaruščica 9b  
10000, Zagreb, Croatia  
Tel. +385916065691 - info.see@clivet.com

**Clivet Airconditioning Systems Pvt Ltd**

Office No.501 & 502,5th Floor, Commercial -I,  
Kohinoor City, Old Premier Compound, Off  
LBS Marg, Kirool Road, Kurla West, Mumbai  
Maharashtra 400070, India  
Tel. +91 22 30930200 - sales.india@clivet.com