

EAGLE Ceiling

Square ceiling diffuser with nozzles for supply air



QUICK FACTS

- Also available in the Extract air version
- Available with circular (EAGLE CC) and rectangular (EAGLE CR) nozzle pattern
- Suitable for VAV and DCV applications
- Fast and simple installation and commissioning through Swegon Quick Access
- Manages airflows substantially below room temperature (High ΔT)
- Designed for modular suspended ceilings
- ALS commissioning box with 1 or 2 changes in dimension between the inlet and outlet
- Available in a version with low installation height
- Adapter for false ceilings
- Standard colour White RAL 9003
 - 5 alternative standard colours
 - Other colours upon request

AIR FLOW - SOUND PRESSURE ROOM (L_{p10A} *)							
EAGLE Ceiling R Size	25 dB(A)		30 dB(A)		35 dB(A)		
	l/s	m ³ /h	l/s	m ³ /h	l/s	m ³ /h	
125-400	36	130	42	151	49	176	
125-600	34	122	41	148	48	173	
160-400	55	198	65	234	75	270	
160-600	50	180	60	216	70	252	
200-500	80	288	92	331	106	382	
200-600	75	270	88	317	103	371	
250-500	102	367	117	421	133	479	
250-600	102	367	117	421	136	490	
315-500	112	403	130	468	148	533	
315-600	130	468	152	547	175	630	
400-600	180	648	208	749	240	864	
EAGLE Ceiling R Size	ALS Size	25 dB(A)		30 dB(A)		35 dB(A)	
		l/s	m ³ /h	l/s	m ³ /h	l/s	m ³ /h
125-400	100-125	27	97	32	115	38	137
125-600	100-125	27	97	32	115	38	137
160-400	125-160	44	158	52	187	61	220
160-600	125-160	42	151	50	180	60	216
200-500	160-200	64	230	75	270	88	317
200-600	160-200	62	223	72	259	86	310
250-500	200-250	88	317	102	367	119	428
250-600	200-250	88	317	102	367	119	428
315-500	250-315	104	374	120	432	138	497
315-600	250-315	119	428	137	493	160	576
400-600	315-400	165	594	190	684	220	792

*) L_{p10A} = Sound pressure incl. A-filter with 4 dB room attenuation and 10 m² room absorption area.

Data specified in the lower table applies to open damper when the commissioning box ALS is used.

Contents

Technical description	3
Design	3
Materials and surface treatment.....	3
Accessories	3
Planning	3
Installation.....	3
Commissioning.....	3
Maintenance.....	3
Environment	3
Installation.....	4
Sizing	5
Sound data - Circular nozzle arrangement - Air diffuser only	5
EAGLE CC - Supply air	5
EAGLE CC – Extract air	5
Sound data - Circular nozzle arrangement - Air diffuser with commissioning box	6
EAGLE CC + ALS - Supply air - One step	6
EAGLE CC + ALS - Supply air - Two steps	6
EAGLE CC + ALS - Extract air – One step	6
Engineering graphs	7
Circular nozzle arrangement - Air diffuser only.....	7
EAGLE CC - Supply air	7
EAGLE CC - Extract air	8
Circular nozzle arrangement - Air diffuser with commissioning box	8
EAGLE CC + ALS - Supply air	8
EAGLE CC + ALS - Extract air	12
Sizing.....	13
Sound data - Square nozzle arrangement - Air diffuser only	13
EAGLE CR – Supply air	13
EAGLE CR – Extract air.....	13
Sound data - Square nozzle arrangement - Air diffuser with commissioning box	14
EAGLE CR + ALS - Supply air - One step.....	14
EAGLE CR + ALS - Supply air - Two steps	14
EAGLE CR + ALS - Extract air – One step.....	14
Square nozzle arrangement - Air diffuser only.....	15
EAGLE CR - Supply air.....	15
EAGLE CR - Extract air	16
Square nozzle arrangement - Air diffuser with commissioning box	16
EAGLE CR + ALS - Supply air.....	16
EAGLE CR + ALS: Extract air.....	21
Dimensions and weights.....	22
Nozzle pattern and nozzle settings.....	23
Examples, circular nozzle arrangement.....	23
Examples, square nozzle arrangement.....	24
Order key.....	25
Specification example	25

Technical description

Design

The square supply air diffuser consists of a diffuser backing box and a diffuser face. The front is equipped with rotatable nozzles and is available in two designs, with a circular nozzle pattern (EAGLE Ceiling Circular, called EAGLE CC) as well as with a rectangular nozzle pattern (EAGLE Ceiling Rectangular, called EAGLE CR). The diffuser face is hung on hinges on one side and secured by springs on the opposite side. This Quick Access fastening system makes it simpler and quicker to open and close the diffuser face for installation, commissioning and cleaning. air diffuser is also available in a low version for installation in a ceiling void where low installation height is required. The air diffuser is then supplied without sleeve coupling (not size 400-600).

Materials and surface treatment

The backing box and diffuser face are made of sheet steel. The connection branch is made of galvanized sheet steel. The interior and exterior of the air diffuser is painted.

- Standard colour:
 - White semi-gloss, lustre 40, RAL 9003/NCS S 0500-N
- Alternative standard colours:
 - Silver gloss, lustre 80, RAL 9006
 - Grey aluminium gloss, lustre 80, RAL 9007
 - White semi-gloss, lustre 40, RAL 9010
 - Black semi-gloss, lustre 35, RAL 9005
 - Grey semi-gloss, lustre 30, RAL 7037
- Non-painted finish and other colours available on request.

The nozzles are made of plastic (PP-polypropylene).

Accessories

Commissioning box:

ALS. Made of galvanized sheet steel. Contains removable commissioning damper, fixed measurement tapplings and sound absorbing material with reinforced surface layer^{*)}. The commissioning box is also available in a low version for installation in a ceiling void where low installation height is required. The air diffuser is then supplied without sleeve coupling. The commissioning box is available with 1 or 2 changes in dimension between the inlet and outlet. Tightness class C on the housing according to SS-EN 12237.

^{*)} Fire Resistance Class B-s1,d0 according to EN ISO 11925-2.

Frame:

SAR K. For aesthetic installation of a lowered diffuser.

Adapter:

See the ADAPTER product sheet for adaptation to various variants and makes of systemized false ceilings: Ecophon, Gyproc, Dampa etc. Also used for adaptation to optional sizes of lay-in ceilings, for instance 625 x 625 or 675 x 675. Specification in separate product sheet for ADAPTER.

Planning

The EAGLE Ceiling is available with square dimensions of 595 x 595 mm in all connection sizes. This makes EAGLE Ceiling very easy to install in 600 x 600 suspended ceiling modules. Position these directly down in the T-bar framework, and then secure them to the duct system or to the commissioning box. EAGLE Ceiling is also available in a low version for installation in ceiling void where low installation height is required. See Figure 2.



Installation

To dismantle the face (see Figure 1) prior to installing the air diffuser, insert a thin object, such as a Quick Access card or similar card, between the air diffuser face and backing box to release the springs. Then slide the card from the centre outward toward the corners. The inlet spigot of the diffuser backing box can be secured to the connecting ducting by means of self-tapping screws or a blind rivets. For flush-mounting in fixed ceiling constructions, secure the diffuser by means of screws into place in the framework through either the sides or top of the diffuser backing box. The face and backing box in the version for low installation height must be centred and jointed together using the locking strip supplied. Secure the air diffuser in the correct position by means of self-tapping screws to the underside of commissioning box.

For mounting in modular suspended ceilings, it is advisable to select air diffusers with outer dimensions of 595 x 595 mm. Position these directly down in the T-bar framework, and then secure them to the duct system or to the commissioning box. If an ALS commissioning box is used, it must be secured to the building structure by means of hangers or mounting brackets.

The distance between the air diffuser and the commissioning box can be increased by as much as 500 mm with an ordinary circular duct without having to lengthen the measuring tubes and damper adjustment cords. See Figure 2.

Commissioning

Commissioning must be carried out with the diffuser face mounted. Pull out the measuring tubes and damper adjustment cords through the diffuser face nozzles. Connect a manometer to the measuring tubes. The desired commissioning pressure can be computed by applying the rated coefficient of performance of the air diffuser. Set the damper blade in the correct position and tie the damper adjustment cords in a commissioning knot to indicate the damper position.

Measurement accuracy and requirement on straight duct before the commissioning box, see Figure 2. The requirements of straight duct depends on the type of disturbance before the commissioning box. Figure 2 shows a bend, a dimensional change and a T-piece. Other types of disturbances requires at least 2xD straight (D = connection dimension) for measurement accuracy of $\pm 10\%$ of the flow.

The rated coefficient of performance (K-factor) is specified on the identification label of the product and the relevant commissioning instructions are also available at www.swegon.com.

Maintenance

The air diffuser can be cleaned, if necessary, using lukewarm water with dishwashing detergent added. The duct system can be accessed after opening the diffuser face. If an ALS commissioning box is used, pull the distributor plate aside and then grip and twist the damper unit from of its mounting. See figure 4.

Environment

The Declaration of construction materials is available at www.swegon.com.

Installation

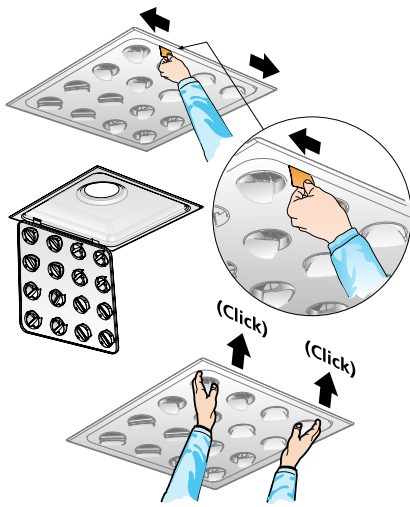

Figure 1. Quick Access, dismantling of the diffuser front.

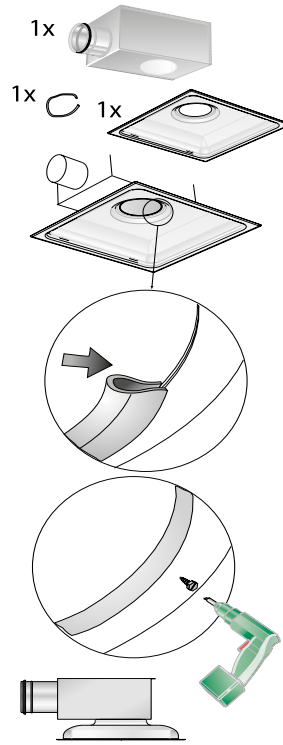

Figure 3. Installing air diffusers and commissioning box with low installation height.

The air diffuser and commissioning box in the low installation height version must be centred and jointed together using the locking strip supplied. Secure the air diffuser in the correct position with self-tapping screws or pop rivets in the underside of the commissioning box.

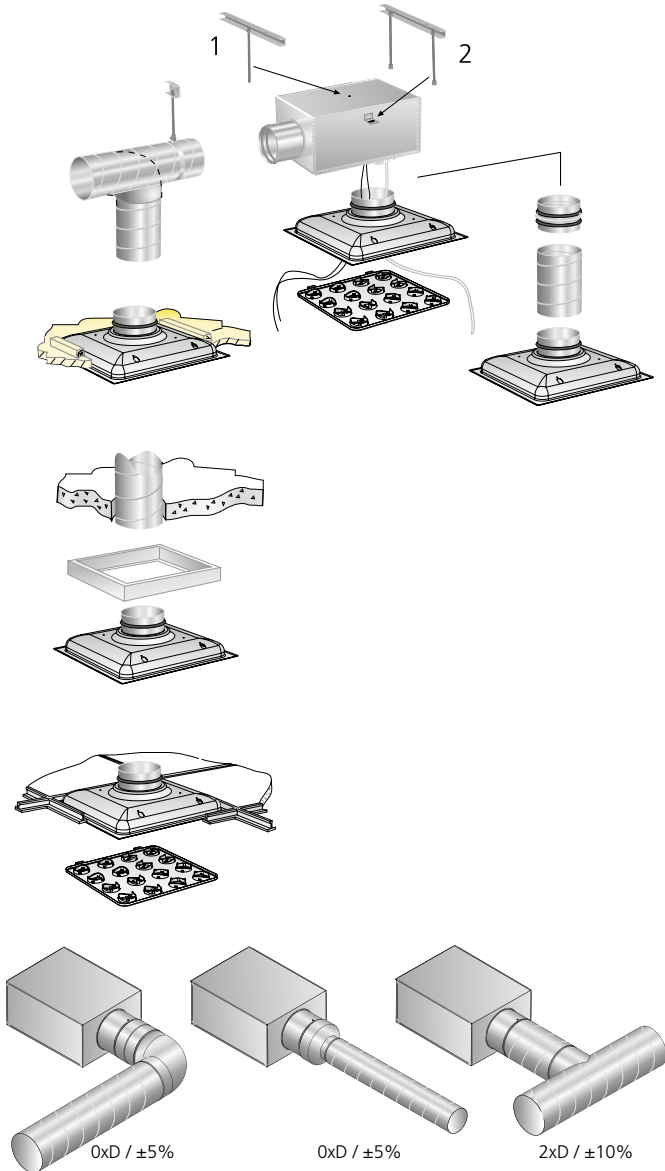

Figure 2. Installation alternatives.

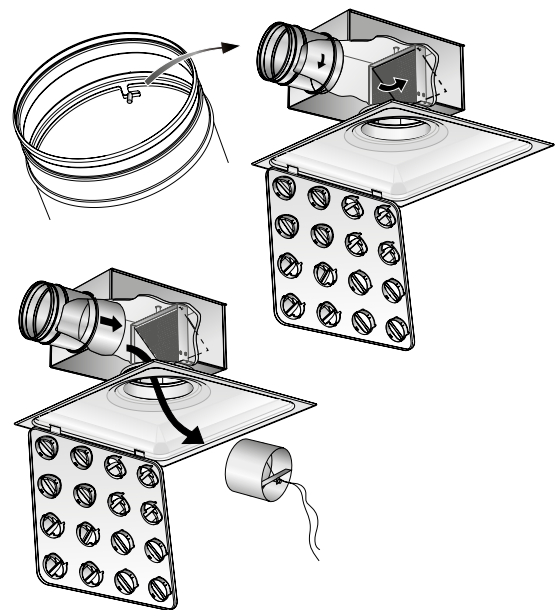

Figure 4. Damper removal.

Sizing

- Sound pressure level dB(A) applies to rooms with 10 m² equivalent sound absorption area.
- Sound attenuation (ΔL) below is shown in the octave band. Orifice attenuation is included in the values.
- Throw $I_{0,2}$ is measured under isothermal conditions.
- Recommended max. permissible temperature below room temperature is 14K.
- For calculating the width of the air stream, air velocities in the occupied zone or sound levels in rooms with other dimensions, please refer to our web calculation softwares available for download at www.swegon.com

L_w = Sound power level

L_{p10A} = Sound pressure level dB (A)

K_{ok} = Correction for producing the L_w value in the octave band

$L_w = L_{p10A} + K_{OK}$ gives the frequency divided octave band

Sound data - Circular nozzle arrangement - Air diffuser only

EAGLE CC - Supply air

Sound power level L_w (dB)

Table K_{OK}

Size	Mid-frequency (Octave band) Hz							
	63	125	250	500	1000	2000	4000	8000
125-400	-8	0	0	3	1	-10	-21	-27
125-600	-13	1	5	4	-2	-9	-20	-27
160-400	-7	1	0	1	2	-9	-22	-28
160-600	-7	1	3	5	-2	-12	-25	-29
200-500	-5	2	1	2	1	-10	-24	-28
200-600	-8	1	2	4	-1	-11	-24	-29
250-500	-7	2	2	1	1	-10	-24	-30
250-600	-12	2	2	3	-1	-12	-25	-29
315-500	-6	3	2	1	1	-9	-23	-30
315-600	-4	4	2	2	0	-9	-22	-29
400-600	-5	4	2	2	1	-10	-23	-28
Tol. \pm	2	2	2	2	2	2	2	2

Sound attenuation ΔL (dB)

Table ΔL

Size	Mid-frequency (Octave band) Hz							
	63	125	250	500	1000	2000	4000	8000
125-400	22	15	10	5	3	5	5	4
125-600	22	15	10	5	3	5	5	4
160-400	20	14	9	4	3	5	5	4
160-600	20	14	9	4	3	5	5	4
200-500	20	14	8	3	3	4	5	5
200-600	20	14	8	3	3	4	5	5
250-500	17	11	5	4	2	3	4	4
250-600	17	11	5	4	2	3	4	4
315-500	16	9	4	2	2	2	3	3
315-600	16	9	4	2	2	2	3	3
400-600	14	8	4	1	0	0	0	0
Tol. \pm	2	2	2	2	2	2	2	2

EAGLE CC – Extract air

Sound power level L_w (dB)

Table K_{OK}

Size	Mid-frequency (Octave band) Hz							
	63	125	250	500	1000	2000	4000	8000
250-500	-8	3	-2	0	1	-4	-11	-24
250-600	-13	6	0	1	0	-5	-12	-24
315-500	-13	0	-2	0	1	-4	-11	-24
315-600	-3	6	1	2	0	-5	-12	-24
400-600	-5	0	-1	1	1	-4	-11	-24
Tol. \pm	2	2	2	2	2	2	2	2

Sound attenuation ΔL (dB)

Table ΔL

Size	Mid-frequency (Octave band) Hz							
	63	125	250	500	1000	2000	4000	8000
250-500	17	11	5	4	2	3	4	4
250-600	17	11	5	4	2	3	4	4
315-500	16	9	4	2	2	2	3	3
315-600	16	9	4	2	2	2	3	3
400-600	14	8	4	1	0	0	0	0
Tol. \pm	2	2	2	2	2	2	2	2

Sound data - Circular nozzle arrangement - Air diffuser with commissioning box

EAGLE CC + ALS - Supply air - One step

Sound power level L_w (dB)

Table K_{OK}

Size	Mid-frequency (Octave band) Hz							
	63	125	250	500	1000	2000	4000	8000
125-400	-2	7	6	3	-2	-9	-14	-20
125-600	-2	8	8	1	-3	-7	-12	-20
160-400	1	7	6	1	-1	-8	-15	-20
160-600	4	7	7	2	-3	-7	-14	-20
200-500	3	7	5	1	-1	-7	-15	-21
200-600	1	5	6	2	-3	-7	-14	-21
250-500	-2	8	5	1	-1	-8	-15	-19
250-600	0	7	4	2	-1	-8	-16	-20
315-500	0	8	4	0	1	-8	-18	-23
315-600	1	8	5	1	-1	-8	-16	-21
400-600	3	8	4	2	0	-9	-18	-25
Tol. \pm	2	2	2	2	2	2	2	2

Sound attenuation ΔL (dB)

Table ΔL

Size	Mid-frequency (Octave band) Hz							
	63	125	250	500	1000	2000	4000	8000
125-400	21	16	9	17	23	16	11	13
125-600	21	16	9	17	23	16	11	13
160-400	19	14	10	17	19	12	10	12
160-600	19	14	10	17	19	12	10	12
200-500	16	11	8	16	18	12	11	11
200-600	16	11	8	16	18	12	11	11
250-500	13	8	8	19	17	12	12	13
250-600	13	8	8	19	17	12	12	13
315-500	11	6	7	16	14	10	10	13
315-600	11	6	7	16	14	10	10	13
400-600	14	5	8	14	11	10	11	12
Tol. \pm	2	2	2	2	2	2	2	2

EAGLE CC + ALS - Supply air - Two steps

Sound power level L_w (dB)

Table K_{OK}

Size	Mid-frequency (Octave band) Hz							
	63	125	250	500	1000	2000	4000	8000
160-400	-6	8	7	2	-4	-7	-12	-17
160-600	-3	10	7	0	-4	-6	-12	-18
200-500	0	8	7	1	-4	-6	-13	-20
200-600	0	8	8	1	-4	-6	-14	-20
250-600	-2	9	6	0	-3	-7	-13	-19
315-500	-2	9	5	-1	-2	-7	-15	-21
315-600	-2	9	4	-1	-3	-7	-13	-19
Tol. \pm	2	2	2	2	2	2	2	2

Sound attenuation ΔL (dB)

Table ΔL

Size	Mid-frequency (Octave band) Hz							
	63	125	250	500	1000	2000	4000	8000
160-400	19	14	11	17	24	15	13	15
160-600	19	14	11	17	24	15	13	15
200-500	18	14	10	16	23	15	14	15
200-600	18	14	10	16	23	15	14	15
250-600	15	9	9	20	19	15	16	14
315-500	13	8	10	19	16	13	16	16
315-600	13	8	10	19	16	13	16	16
Tol. \pm	2	2	2	2	2	2	2	2

EAGLE CC + ALS - Extract air - One step

Sound power level L_w (dB)

Table K_{OK}

Size	Mid-frequency (Octave band) Hz							
	63	125	250	500	1000	2000	4000	8000
250-500	-3	10	5	-3	-3	-6	-14	-22
250-600	-3	12	6	-2	-3	-8	-15	-23
315-500	0	8	4	0	1	-8	-18	-23
315-600	-1	10	2	-2	-2	-6	-15	-24
400-600	-3	4	-1	-3	-1	-3	-12	-25
Tol. \pm	2	2	2	2	2	2	2	2

Sound attenuation ΔL (dB)

Table ΔL

Size	Mid-frequency (Octave band) Hz							
	63	125	250	500	1000	2000	4000	8000
250-500	13	8	8	16	17	12	12	13
250-600	13	8	8	16	17	12	12	13
315-500	11	6	7	19	14	10	10	13
315-600	11	6	7	19	14	10	10	13
400-600	14	5	8	14	11	10	11	12
Tol. \pm	2	2	2	2	2	2	2	2

Engineering graphs

- The graphs must not to be used for commissioning.
- The dB(A) values are applicable to rooms with normal acoustic absorption of 4 dB.
- Sound level L_A dB(A) applies to rooms of 10 m² equivalent absorption area.
- The dB(C) value is normally 6-9 dB higher than the dB(A) value.
- Air diffuser size 250-500 and 315-500 adapted for ADAPTER

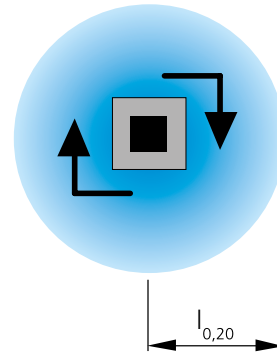

Circular nozzle arrangement - Air diffuser only

EAGLE CC - Supply air

Air flow – Pressure drop – Sound level – Throw

- Throw $l_{0,2}$ is measured under isothermal conditions.
- Recommended max. permissible temperature below room temperature is 14K.
- For calculating the width of the air stream, air velocities in the occupied zone or sound levels in rooms with other dimensions, please refer to our web calculation softwares available for download at www.swegon.com
- The graphs illustrate data for the air diffuser recessed in a ceiling.
- Throw for adjusting the swirl. For other adjustments, see the graphs for diffusers with the ALS commissioning box.

EAGLE CC 250-500, 315-500 - Supply air

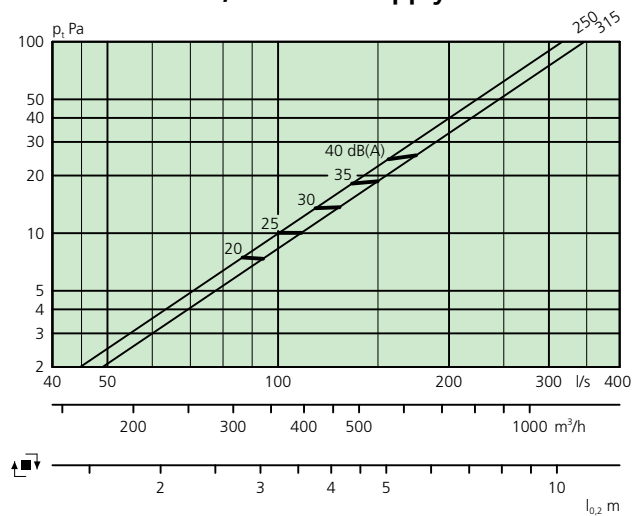

EAGLE CC 125-400, 160-400 and 200-500 – Supply air

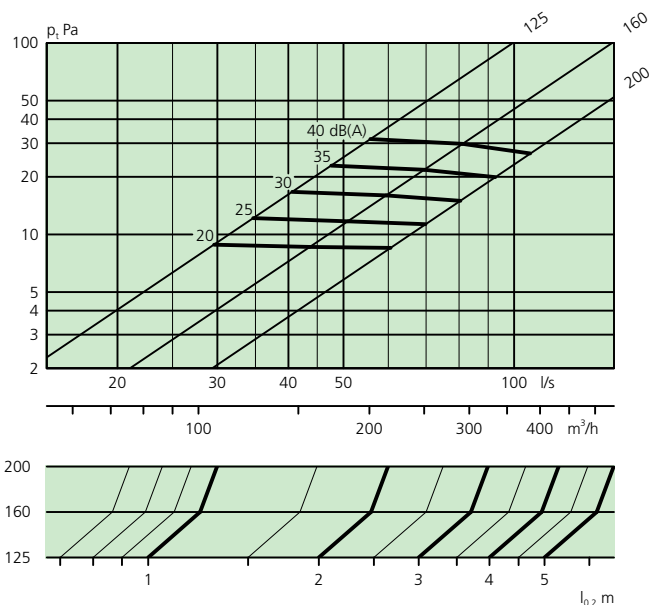

EAGLE CC 125-600, 160-600, 200-600, 250-600, 315-600 and 400-600 - Supply air

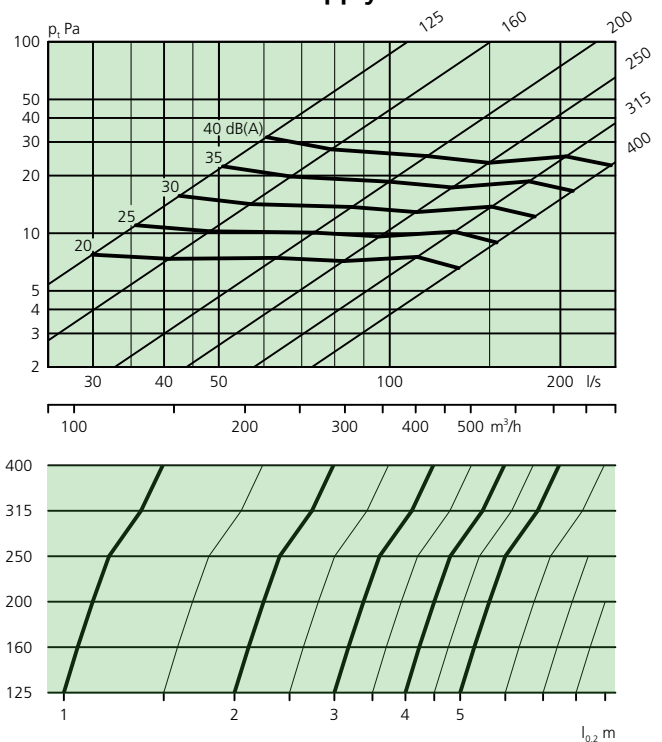

Circular nozzle arrangement - Air diffuser only

EAGLE CC - Extract air

EAGLE CC 250-500, 315-500 - Extract air

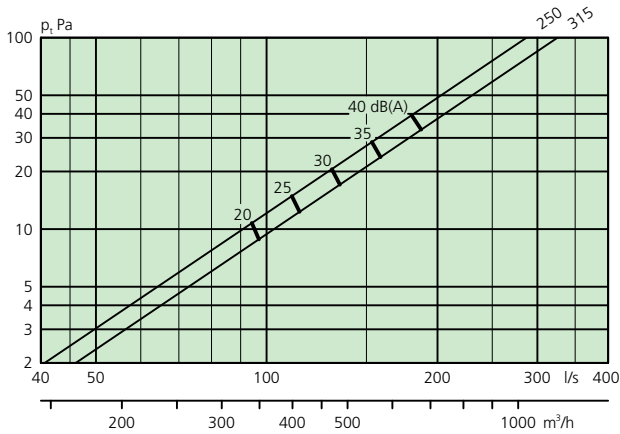

EAGLE CC 250-600, 315-600 and 400-600 - Extract air

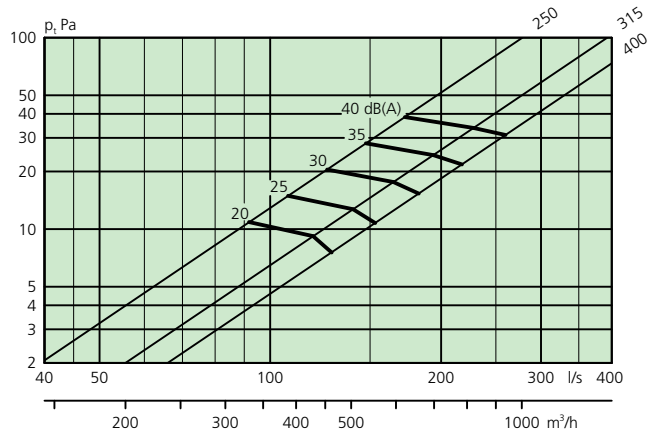

Circular nozzle arrangement - Air diffuser with commissioning box

EAGLE CC + ALS - Supply air

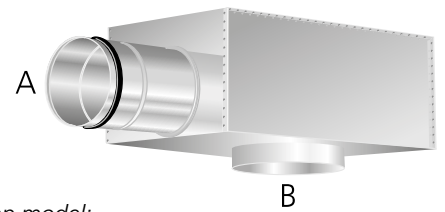

Air flow – Pressure drop – Sound level – Throw

- The graphs illustrate data for the air diffuser recessed in a ceiling.
- ∇ = Min. airflow required for obtaining sufficient commissioning pressure.
- The version for low installation height generates 3 dB(A) higher sound level than the value plotted in the graph.

Explanation of the step model:

- One step = One dimensional change between A and B, for example, A = $\varnothing 160$ mm and B = $\varnothing 200$ mm.
- Two steps = Two dimensional changes between A and B, for example, A = $\varnothing 160$ mm and B = $\varnothing 250$ mm.

EAGLE CC 125-400 + ALS 100-125 - One step

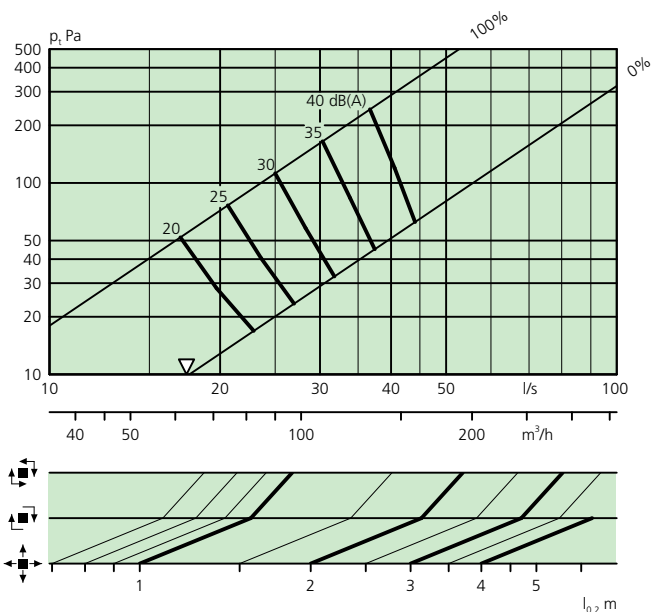

EAGLE CC 125-600 + ALS 100-125 - One step

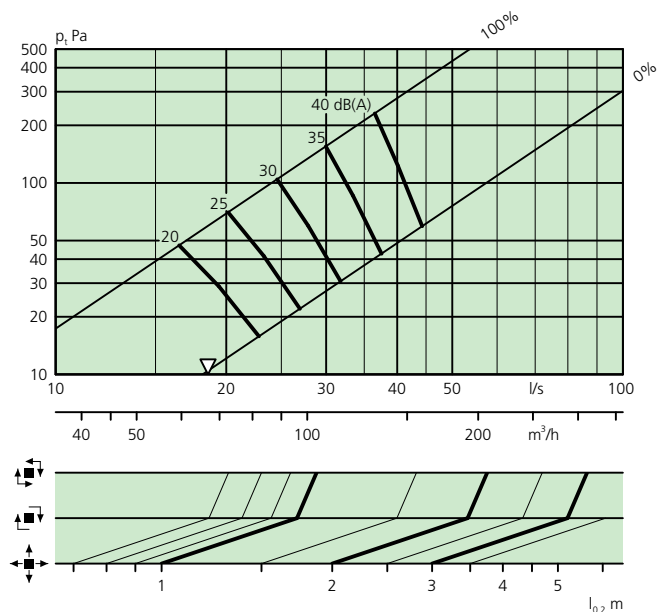

EAGLE CC 160-400 + 100-160 - Two steps

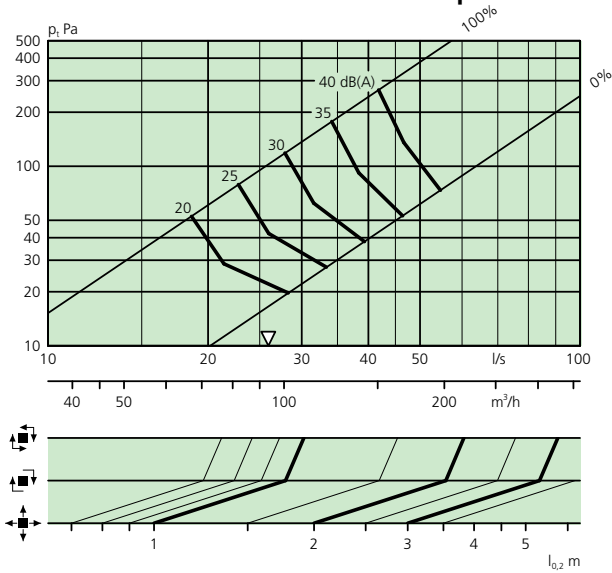

EAGLE CC 160-600 + ALS 125-160 - One step

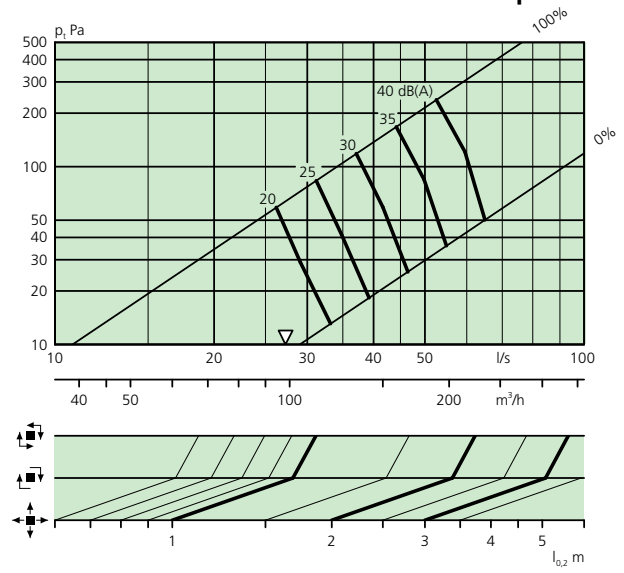

EAGLE CC 160-400 + ALS 125-160 - One step

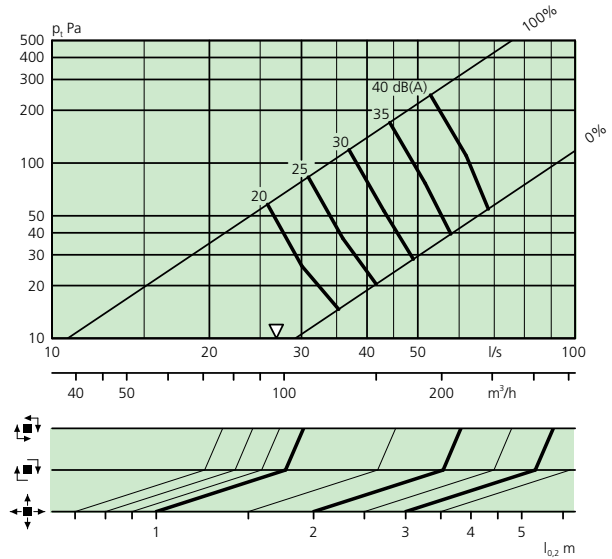

EAGLE CC 200-500 + ALS 125-200 - Two steps

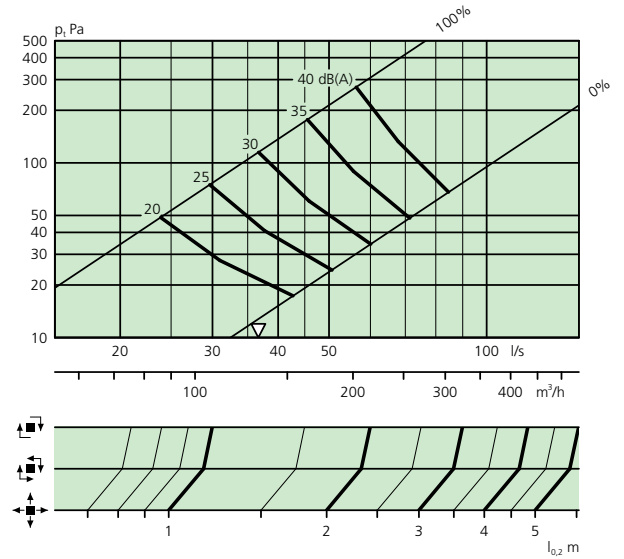

EAGLE CC 160-600 + ALS 100-160 - Two steps

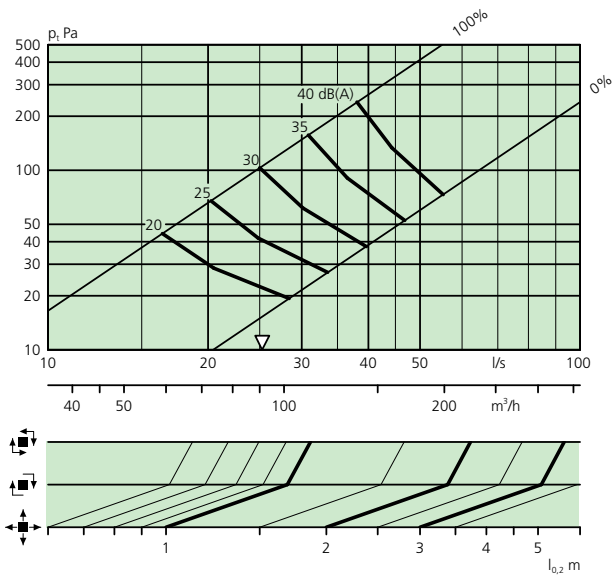

EAGLE CC 200-500 + ALS 160-200 - One step

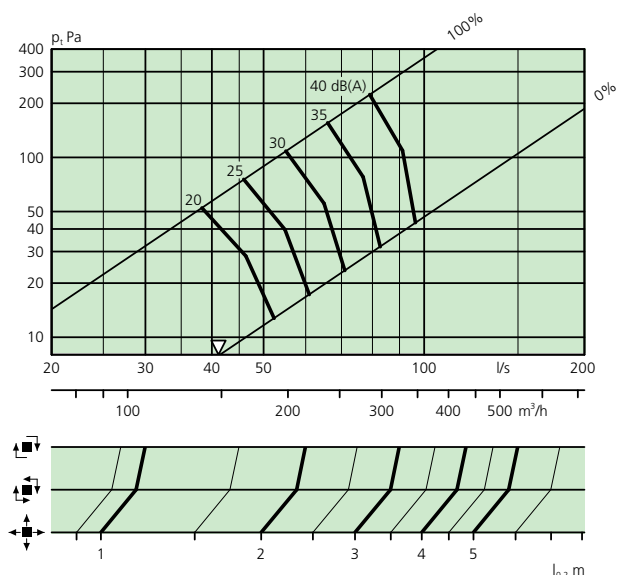

EAGLE CC 200-600 + ALS 125-200 - Two steps

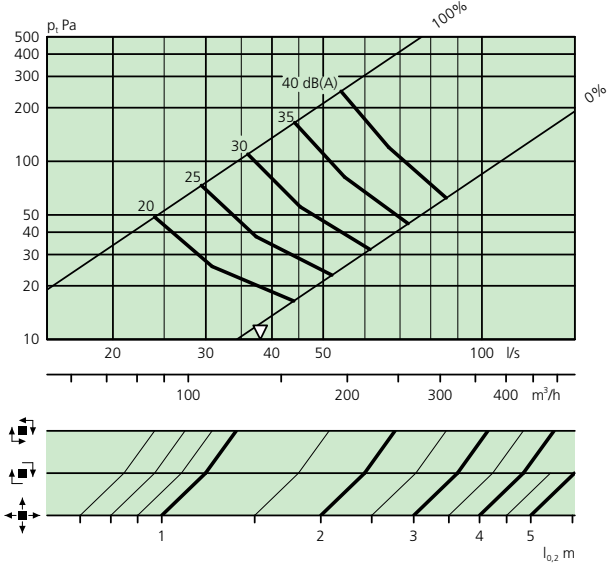

EAGLE CC 250-600 + ALS 160-250 - Two steps

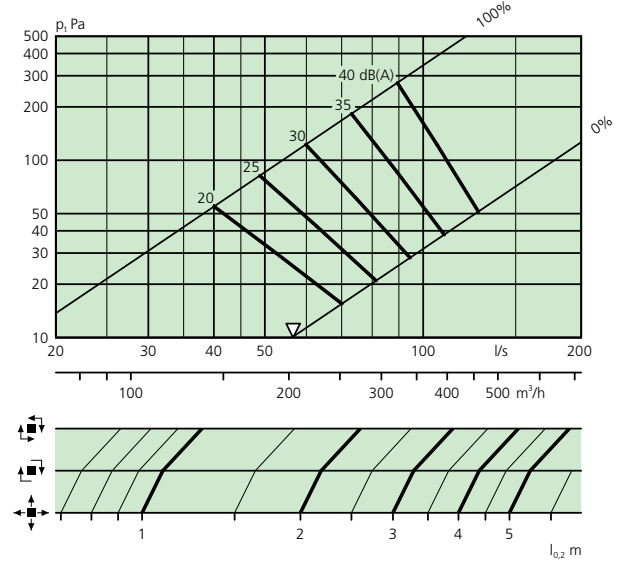

EAGLE CC 200-600 + ALS 160-200 - One step

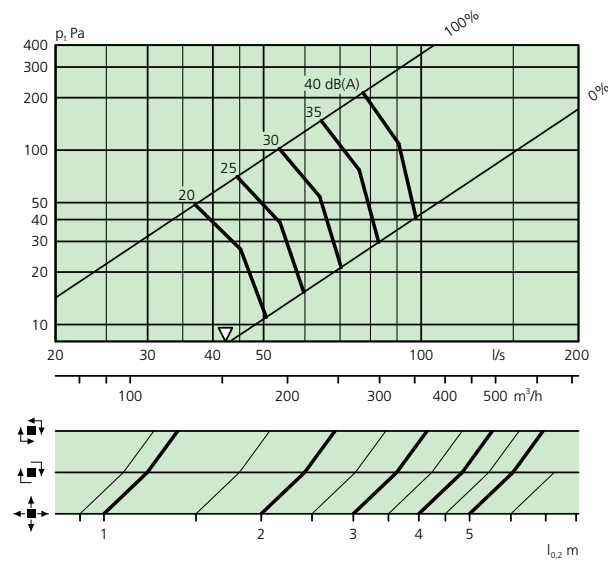

EAGLE CC 250-600 + ALS 200-250 - One step

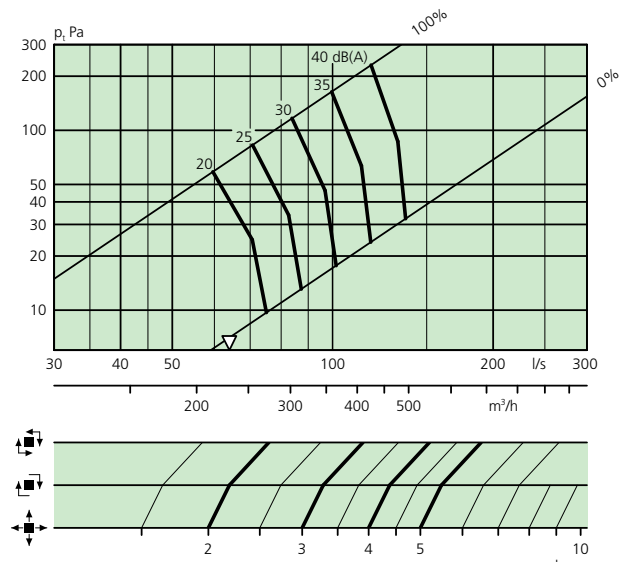

EAGLE CC 250-500 + ALS 200-250 - One step

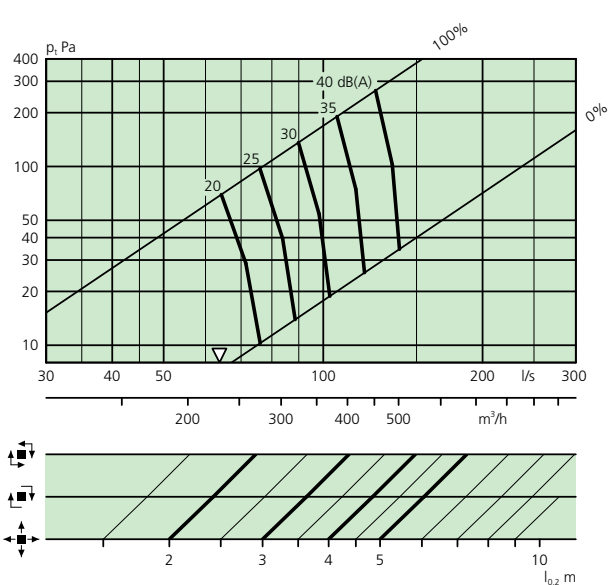

EAGLE CC 315-500 + ALS 200-315 - One step

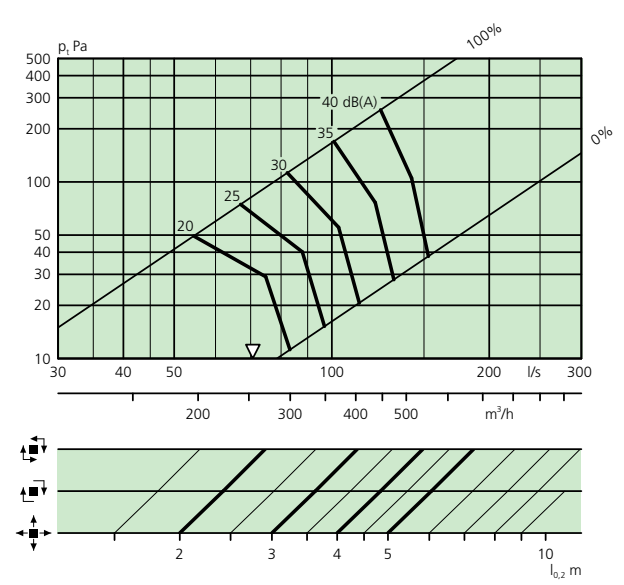

EAGLE CC 315-500 + ALS 250-315 - One step

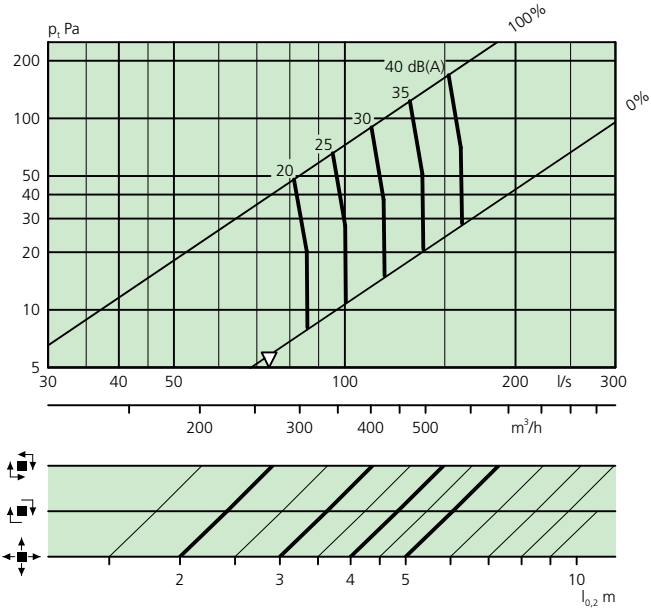

EAGLE CC 315-600 + ALS 250-315 - One step

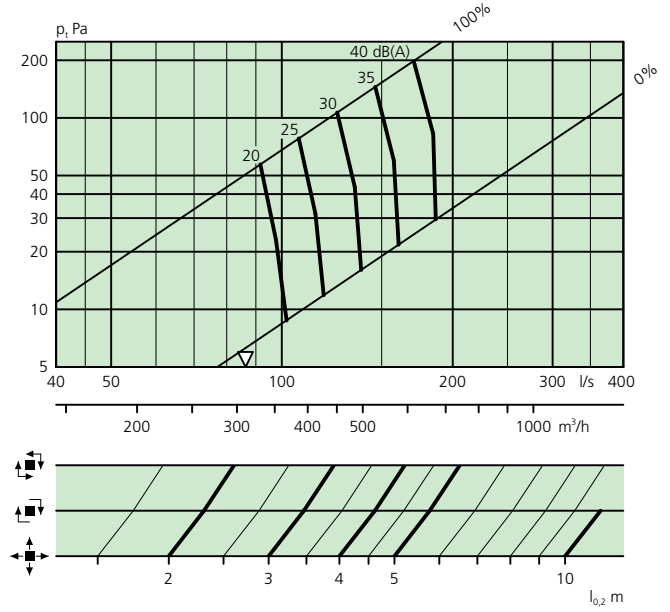

EAGLE CC 315-600 + ALS 200-315 - Two steps

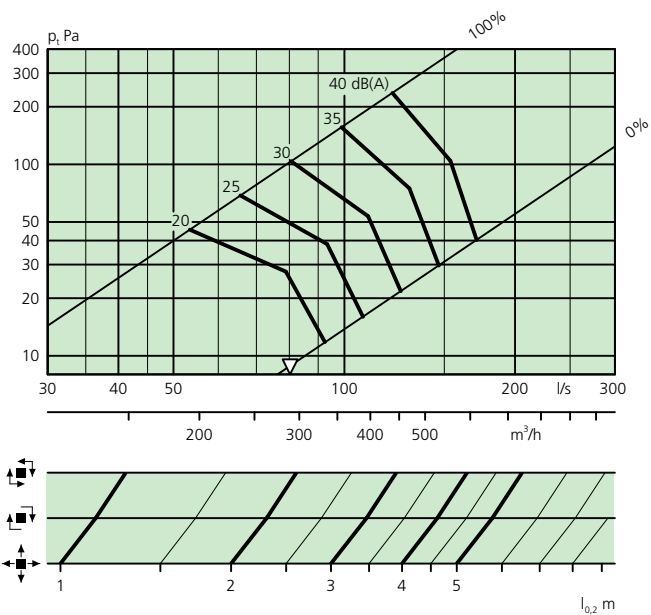

EAGLE CC 400-600 + ALS 315-400 - One step

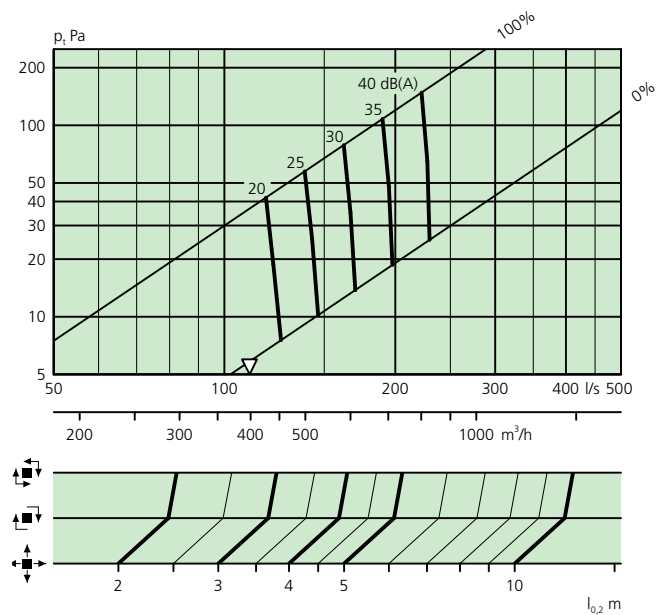

Circular nozzle arrangement - Air diffuser with commissioning box

EAGLE CC + ALS - Extract air

Air flow – Pressure drop – Sound level – Throw

- ∇ = Min. airflow required for obtaining sufficient commissioning pressure.
- The version for low installation height generates 3 dB(A) higher sound level than the value plotted in the graph.

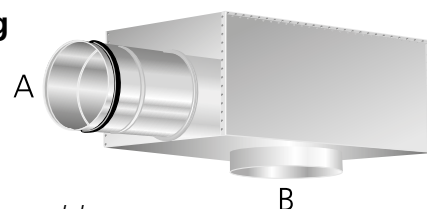

Explanation of the step model:

- One step = One dimensional change between A and B, for example, A = Ø160 mm and B = Ø200 mm.
- Two steps = Two dimensional changes between A and B, for example, A = Ø160 mm and B = Ø250 mm.

EAGLE CC 250-500 + ALS 200-250 - One step

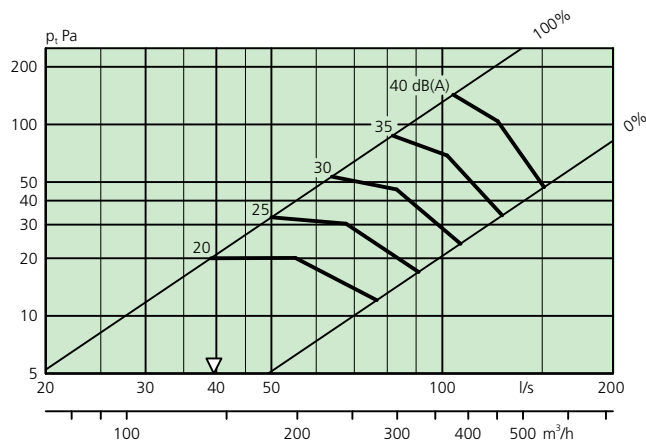

EAGLE CC 315-600 + ALS 250-315 - One step

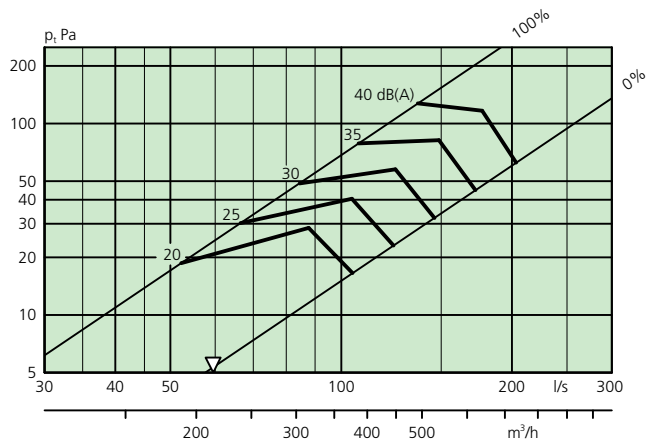

EAGLE CC 250-600 + ALS 200-250 - One step

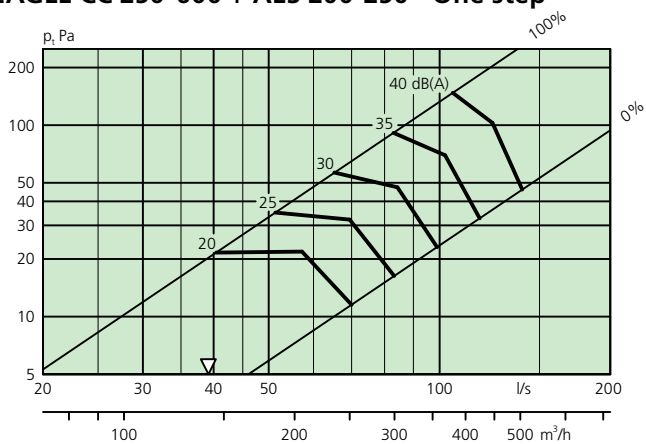

EAGLE CC 400-600 + ALS 315-400 - One step

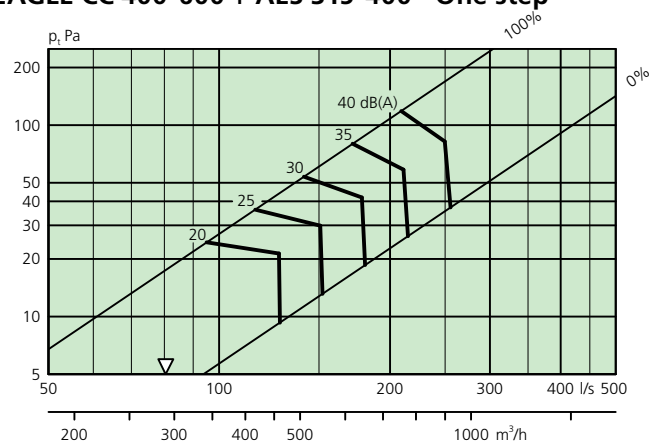

EAGLE CC 315-500 + ALS 250-315 - One step

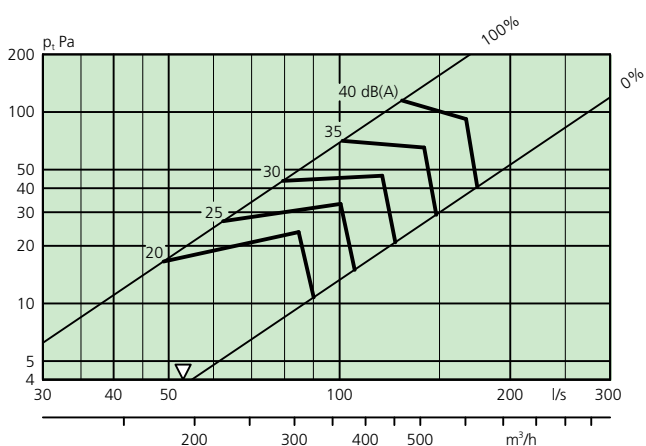

Sizing

- Sound pressure level dB(A) applies to rooms with 10 m² equivalent sound absorption area.
- Sound attenuation (ΔL) below is shown in the octave band. Orifice attenuation is included in the values.
- Throw I_{0,2} is measured under isothermal conditions.
- Recommended max. permissible temperature below room temperature is 14K.
- For calculating the width of the air stream, air velocities in the occupied zone or sound levels in rooms with other dimensions, please refer to our web calculation softwares available for download at www.swegon.com

L_w = Sound power level

L_{p10A} = Sound pressure level dB (A)

K_{ok} = Correction for producing the L_w value in the octave band

L_w = L_{p10A} + K_{OK} gives the frequency divided octave band

Sound data - Square nozzle arrangement - Air diffuser only

EAGLE CR – Supply air

Sound power level L_w (dB)

Table K_{OK}

Size	Mid-frequency (Octave band) Hz							
	63	125	250	500	1000	2000	4000	8000
125-400	-4	1	1	3	1	-11	-22	-25
125-600	1	3	5	5	-4	-13	-23	-23
160-400	-6	3	1	1	2	-9	-21	-27
160-600	-1	2	3	5	-3	-12	-23	-24
200-500	-3	3	1	2	1	-11	-23	-24
200-600	-6	3	2	5	-2	-13	-25	-24
250-500	-6	1	2	1	2	-9	-23	-29
250-600	-3	2	2	3	0	-11	-24	-25
315-500	-6	2	2	1	1	-8	-22	-28
315-600	-2	4	4	1	1	-9	-23	-28
400-600	4	6	6	4	3	-6	-19	-22
Tol. ±	2	2	2	2	2	2	2	2

Sound attenuation ΔL (dB)

Table ΔL

Size	Mid-frequency (Octave band) Hz							
	63	125	250	500	1000	2000	4000	8000
125-400	22	15	10	5	3	5	5	4
125-600	22	15	10	5	3	5	5	4
160-400	20	14	9	4	3	5	5	4
160-600	20	14	9	4	3	5	5	4
200-500	20	14	8	3	3	4	5	5
200-600	20	14	8	3	3	4	5	5
250-500	17	11	5	4	2	3	4	4
250-600	17	11	5	4	2	3	4	4
315-500	16	9	4	2	2	2	3	3
315-600	16	9	4	2	2	2	3	3
400-600	14	8	4	1	0	0	0	0
Tol. ±	2	2	2	2	2	2	2	2

EAGLE CR – Extract air

Sound power level L_w (dB)

Table K_{OK}

Size	Mid-frequency (Octave band) Hz							
	63	125	250	500	1000	2000	4000	8000
250-500	-2	5	0	0	2	-7	-17	-26
250-600	-1	7	1	1	1	-7	-17	-24
315-500	-5	4	0	0	1	-6	-16	-27
315-600	-4	8	3	2	1	-8	-18	-25
400-600	5	7	5	3	3	-5	-15	-19
Tol. ±	2	2	2	2	2	2	2	2

Sound attenuation ΔL (dB)

Table ΔL

Size	Mid-frequency (Octave band) Hz							
	63	125	250	500	1000	2000	4000	8000
250-500	16	11	5	4	2	3	4	4
250-600	16	11	5	4	2	3	4	4
315-500	14	9	4	2	2	2	3	3
315-600	14	9	4	2	2	2	3	3
400-600	13	8	4	1	0	0	0	0
Tol. ±	2	2	2	2	2	2	2	2

Sound data - Square nozzle arrangement - Air diffuser with commissioning box

EAGLE CR + ALS - Supply air - One step

Sound power level L_w (dB)

Table K_{OK}

Size	Mid-frequency (Octave band) Hz							
	63	125	250	500	1000	2000	4000	8000
125-400	1	8	6	3	-3	-12	-17	-18
125-600	3	9	8	3	-4	-12	-17	-21
160-400	6	8	7	1	-2	-10	-16	-17
160-600	6	7	7	3	-4	-10	-16	-17
200-500	2	6	5	0	-3	-8	-13	-16
200-600	1	6	6	2	-4	-8	-14	-15
250-500	-2	8	4	-1	-1	-7	-15	-20
250-600	-1	7	4	2	-1	-9	-15	-17
315-500	-6	2	2	1	1	-8	-22	-28
315-600	1	8	5	1	0	-8	-16	-20
400-600	7	11	6	3	2	-6	-15	-17
Tol. ±	2	2	2	2	2	2	2	2

Sound attenuation ΔL (dB)

Table ΔL

Size	Mid-frequency (Octave band) Hz							
	63	125	250	500	1000	2000	4000	8000
125-400	22	16	9	17	23	16	11	13
125-600	22	16	9	17	23	16	11	13
160-400	20	14	10	17	19	12	10	12
160-600	20	14	10	17	19	12	10	12
200-500	20	11	8	16	18	12	11	11
200-600	20	11	8	16	18	12	11	11
250-500	17	8	8	19	17	12	12	13
250-600	17	8	8	19	17	12	12	13
315-500	16	6	7	16	14	10	10	13
315-600	16	6	7	16	14	10	10	13
400-600	10	5	8	14	11	10	11	12
Tol. ±	2	2	2	2	2	2	2	2

EAGLE CR + ALS - Supply air - Two steps

Sound power level L_w (dB)

Table K_{OK}

Size	Mid-frequency (Octave band) Hz							
	63	125	250	500	1000	2000	4000	8000
160-400	0	10	7	2	-4	-8	-13	-17
160-600	0	10	7	2	-4	-8	-13	-17
200-500	2	9	7	1	-5	-7	-13	-17
200-600	2	8	7	1	-5	-8	-15	-16
250-600	2	9	5	-1	-4	-8	-14	-15
315-500	4	9	5	-2	-1	-6	-14	-20
315-600	2	10	5	-2	-3	-7	-13	-16
Tol. ±	2	2	2	2	2	2	2	2

Sound attenuation ΔL (dB)

Table ΔL

Size	Mid-frequency (Octave band) Hz							
	63	125	250	500	1000	2000	4000	8000
160-400	19	14	11	17	24	15	13	15
160-600	19	14	11	17	24	15	13	15
200-500	18	14	10	16	23	15	14	15
200-600	18	14	10	16	23	15	14	15
250-600	15	9	9	20	19	15	16	14
315-500	13	8	10	19	16	13	16	16
315-600	13	8	10	19	16	13	16	16
Tol. ±	2	2	2	2	2	2	2	2

EAGLE CR + ALS - Extract air – One step

Sound power level L_w (dB)

Table K_{OK}

Size	Mid-frequency (Octave band) Hz							
	63	125	250	500	1000	2000	4000	8000
250-500	2	14	8	1	0	-4	-10	-16
250-600	2	14	8	1	0	-4	-10	-16
315-500	0	8	3	-2	-1	-5	-13	-23
315-600	3	12	6	1	2	-3	-11	-18
400-600	7	12	5	2	2	-5	-13	-18
Tol. ±	2	2	2	2	2	2	2	2

Sound attenuation ΔL (dB)

Table ΔL

Size	Mid-frequency (Octave band) Hz							
	63	125	250	500	1000	2000	4000	8000
250-500	17	8	8	19	17	12	12	13
250-600	17	8	8	19	17	12	12	13
315-500	16	6	7	16	14	10	10	13
315-600	16	6	7	16	14	10	10	13
400-600	10	5	8	14	11	10	11	12
Tol. ±	2	2	2	2	2	2	2	2

Square nozzle arrangement - Air diffuser only

EAGLE CR - Supply air

Air flow – Pressure drop – Sound level – Throw

- Throw $l_{0,2}$ is measured under isothermal conditions.
- Recommended max. permissible temperature below room temperature is 14K.
- For calculating the width of the air stream, air velocities in the occupied zone or sound levels in rooms with other dimensions, please refer to our web calculation softwares available for download at www.swegon.com
- The graphs illustrate data for the air diffuser recessed in a ceiling.
- Throw for adjusting the swirl. For other adjustments, see the graphs for diffusers with the ALS commissioning box.
- The graphs must not to be used for commissioning.
- The dB(A) values are applicable to rooms with normal acoustic absorption of 4 dB.
- The dB(C) value is normally 6-9 dB higher than the dB(A) value.
- Air diffuser size 250-500 and 315-500 adapted for ADAPTER

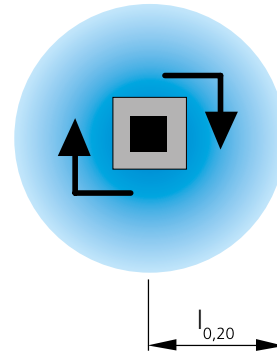

EAGLE CR 125-400, 160-400 and 200-500 – Supply air

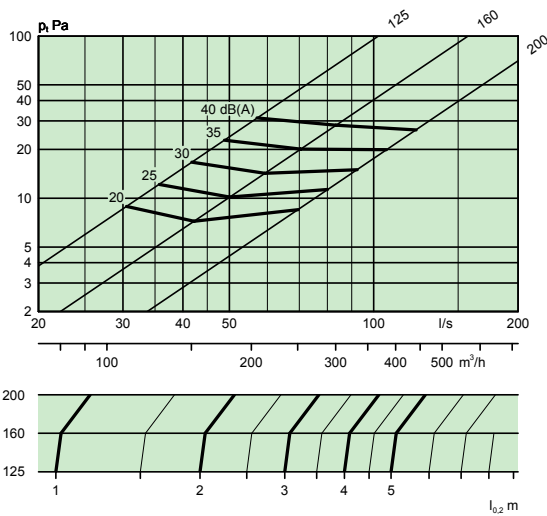

EAGLE CR 250-500, 315-500 – Supply air

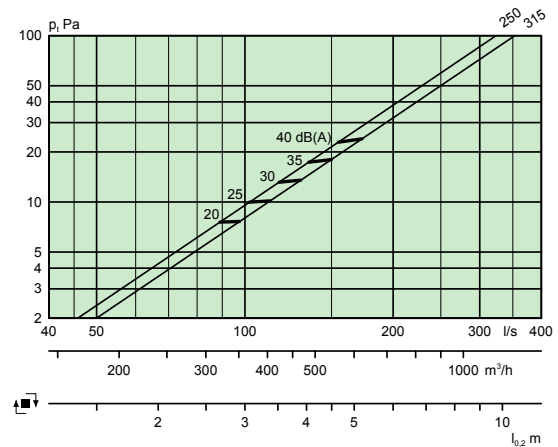

EAGLE CR 125-600, 160-600 and 200-600 – Supply air

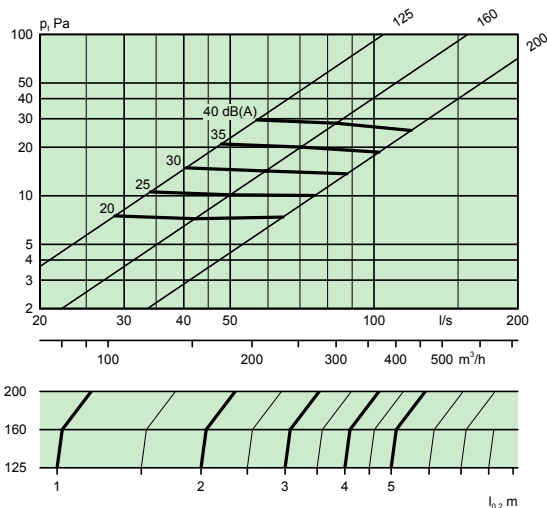

EAGLE CR 250-600, 315-600 and 400-600 – Supply air

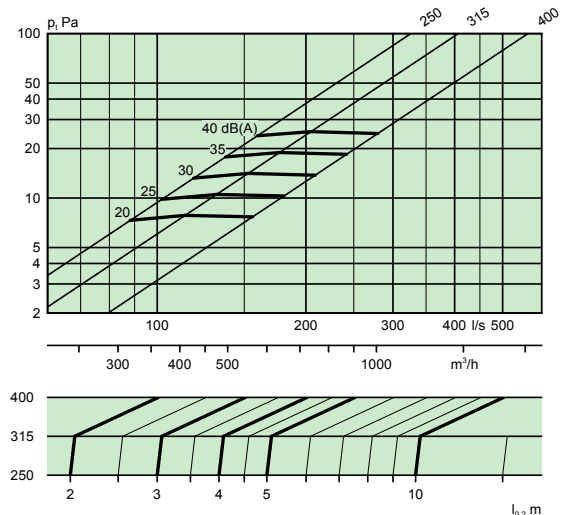

EAGLE CR - Extract air

EAGLE CR 250-500, 315-500 – Extract air

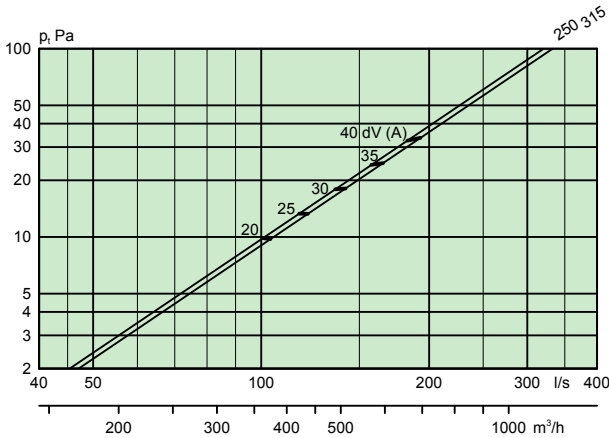

EAGLE CR 250-600, 315-600 and 400-600 – Extract air

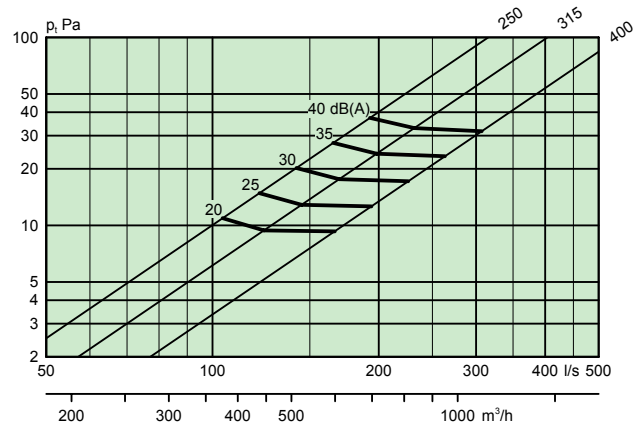

Square nozzle arrangement - Air diffuser with commissioning box

EAGLE CR + ALS - Supply air

Air flow – Pressure drop – Sound level – Throw

- The graphs illustrate data for the air diffuser recessed in a ceiling.
- ∇ = Min. airflow required for obtaining sufficient commissioning pressure.
- The version for low installation height generates 3 dB(A) higher sound level than the value plotted in the graph.

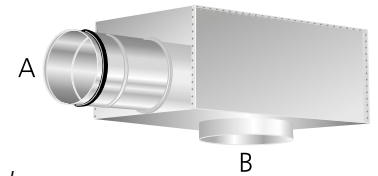

Explanation of the step model:

- One step = One dimensional change between A and B, for example, A = Ø160 mm and B = Ø200 mm.
- Two steps = Two dimensional changes between A and B, for example, A = Ø160 mm and B = Ø250 mm.

EAGLE CR 125-400 + ALS 100-125 – One step

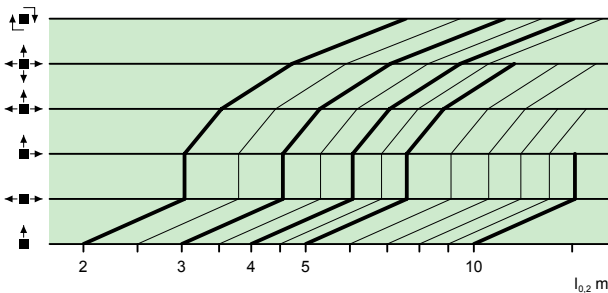
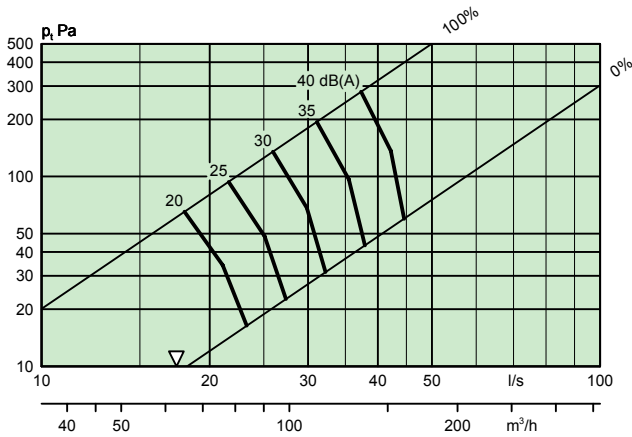

EAGLE CR 160-400 + ALS 100-160 – Two steps

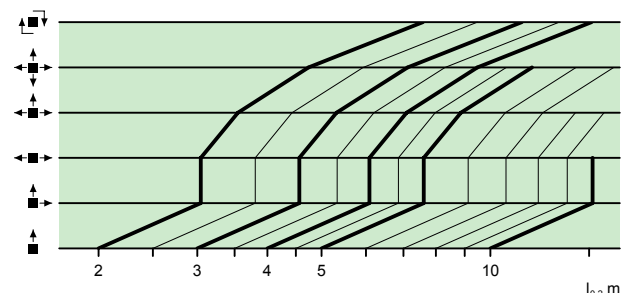
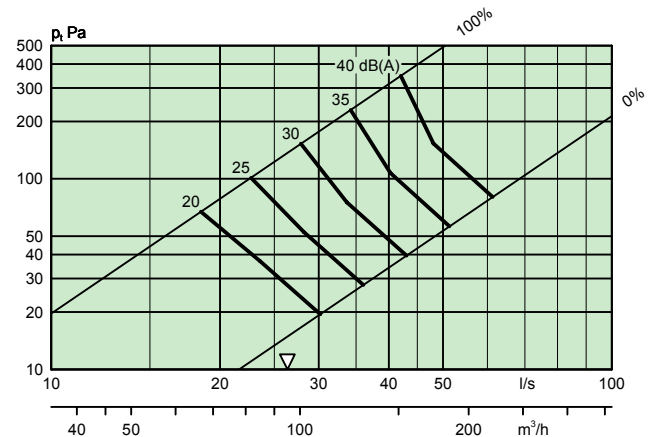

EAGLE CR 125-600 + ALS 100-125 – One step

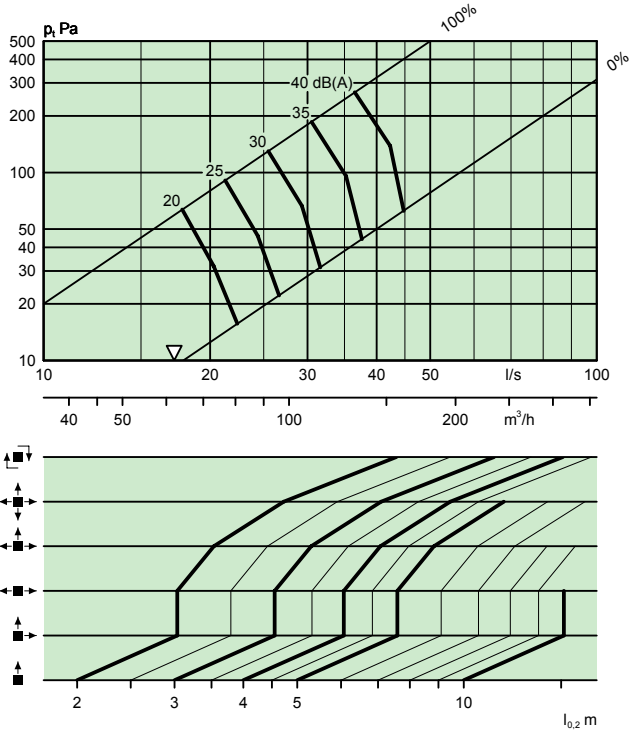

EAGLE CR 160-400 + ALS 125-160 – One step

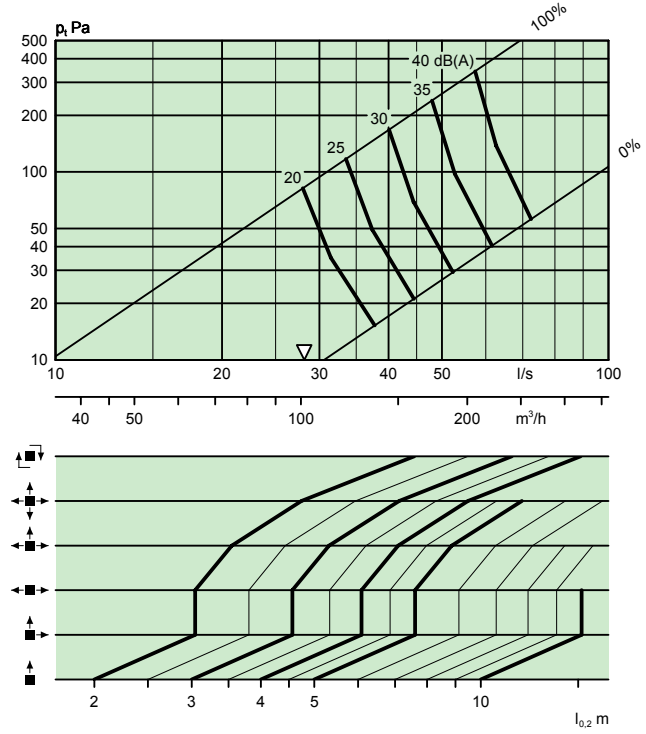

EAGLE CR 160-600 + ALS 100-160 – Two steps

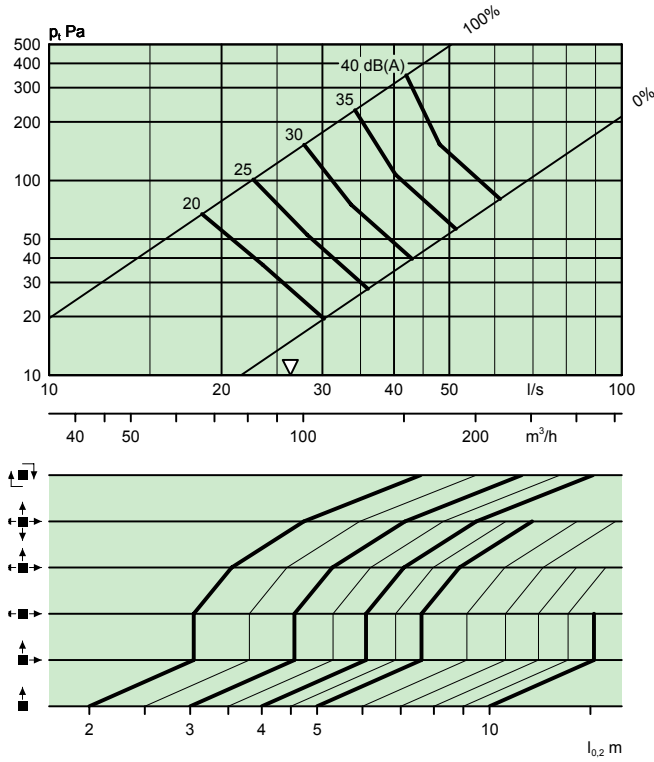

EAGLE CR 200-500 + ALS 125-200 – Two steps

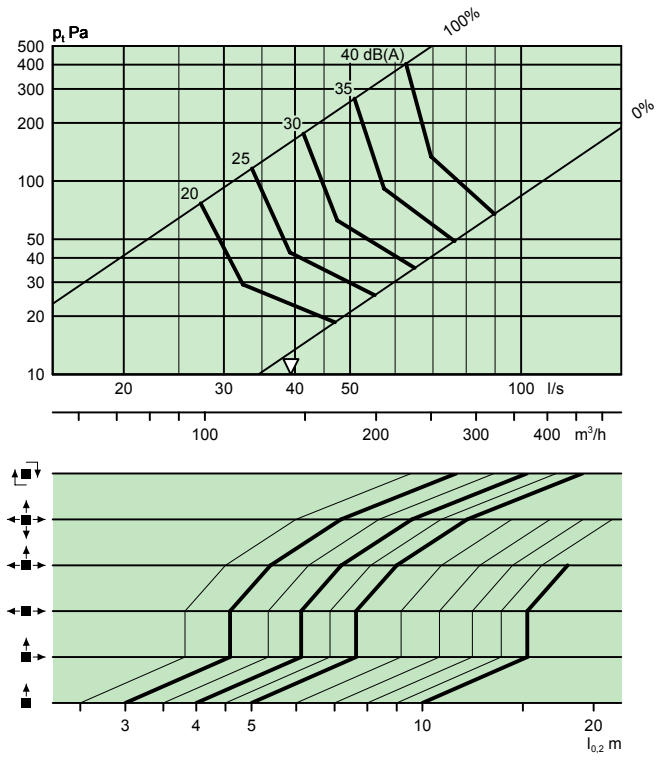

EAGLE CR 160-600 + ALS 125-160 – One step

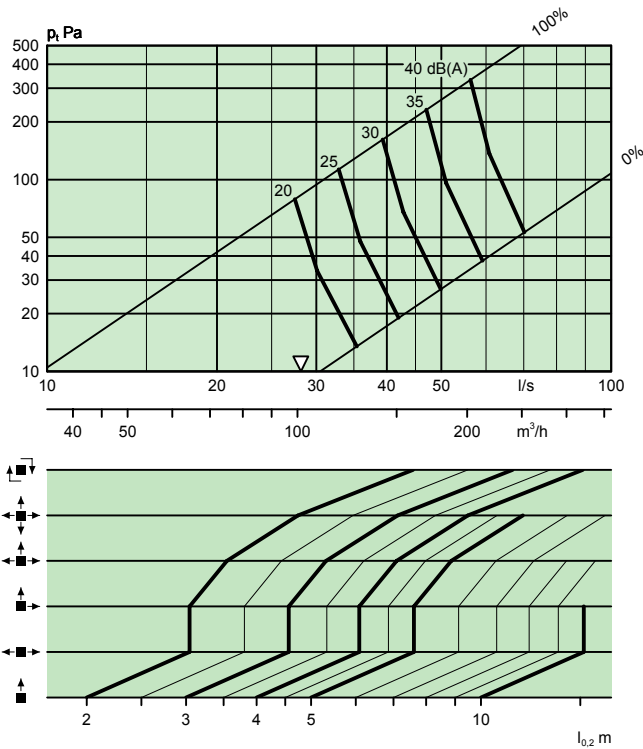

EAGLE CR 200-500 + ALS 160-200 – One step

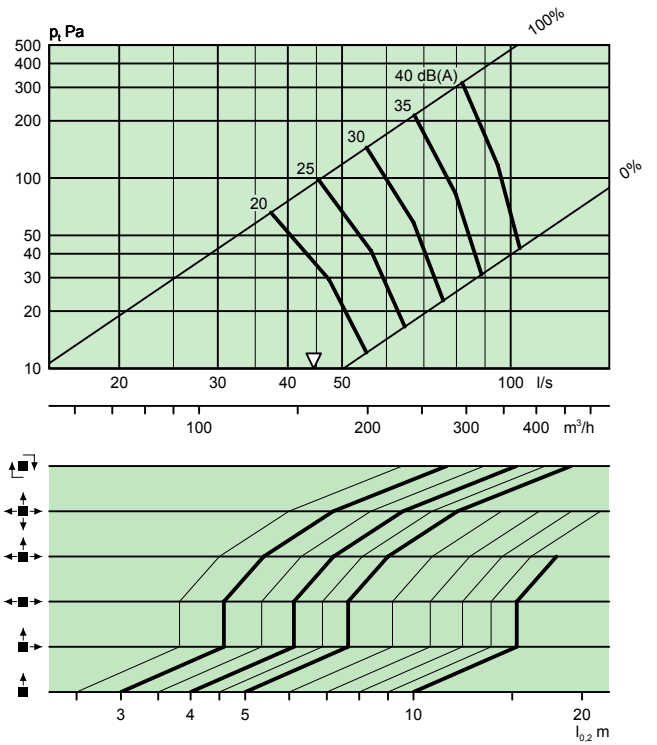

EAGLE CR 200-600 + ALS 125-200 – Two steps

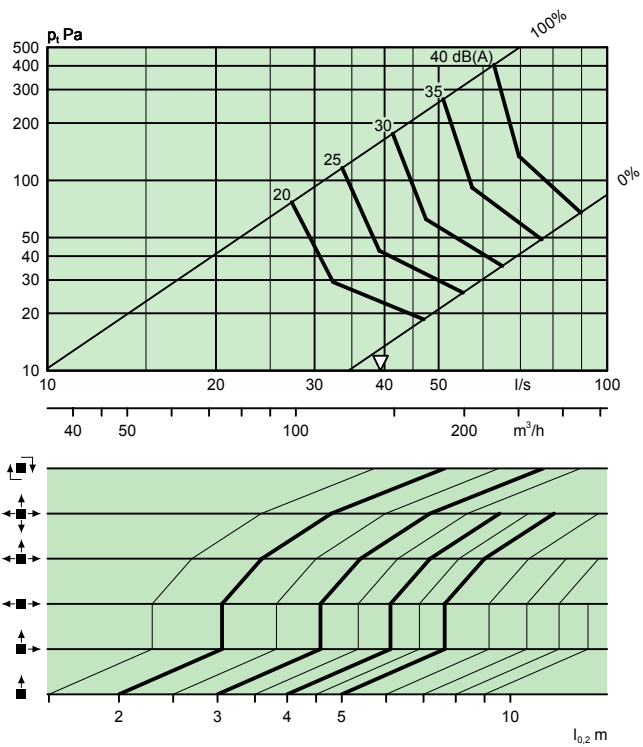

EAGLE CR 250-500 + ALS 200-250 – One step

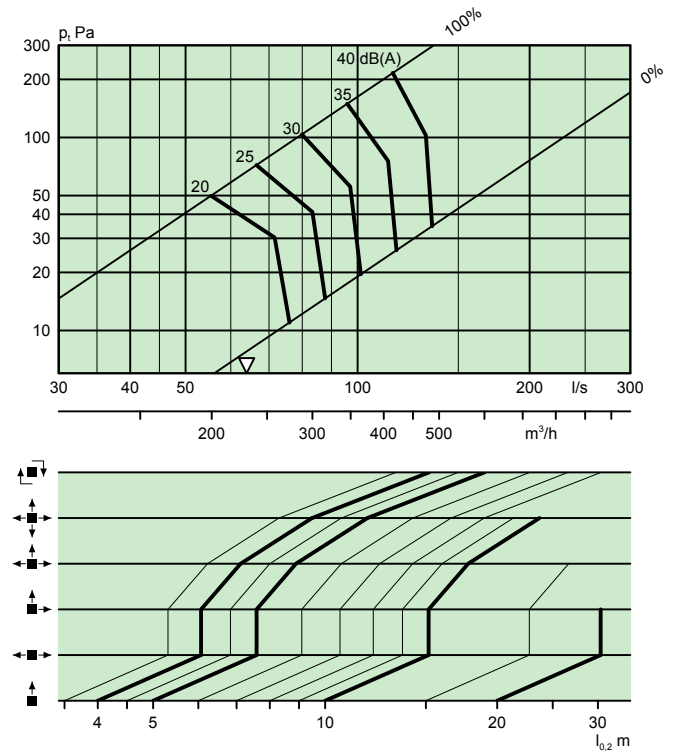

EAGLE CR 200-600 + ALS 160-200 – One step

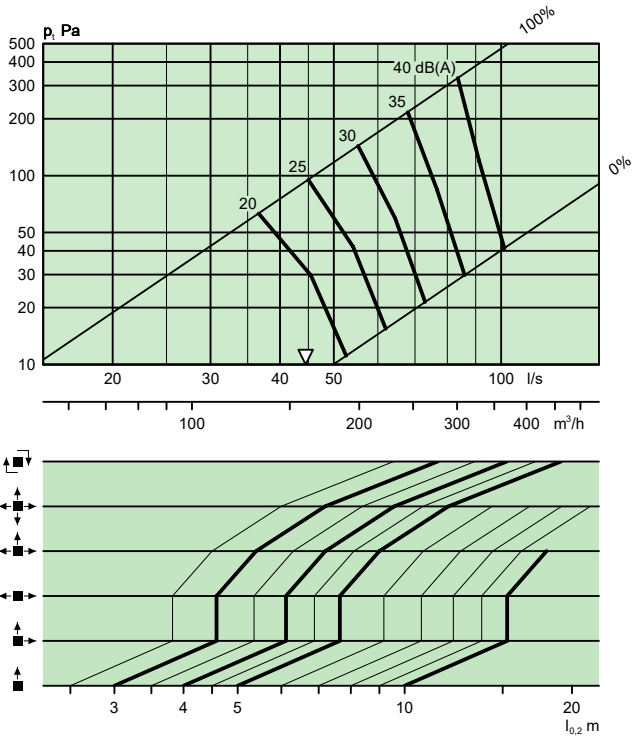

EAGLE CR 250-600 + ALS 160-250 – Two steps

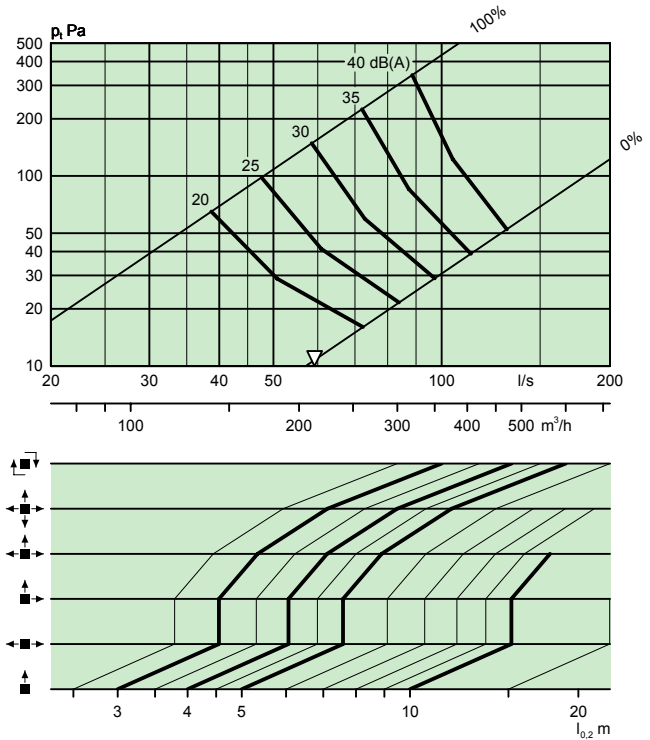

EAGLE CR 250-600 + ALS 200-250 – One step

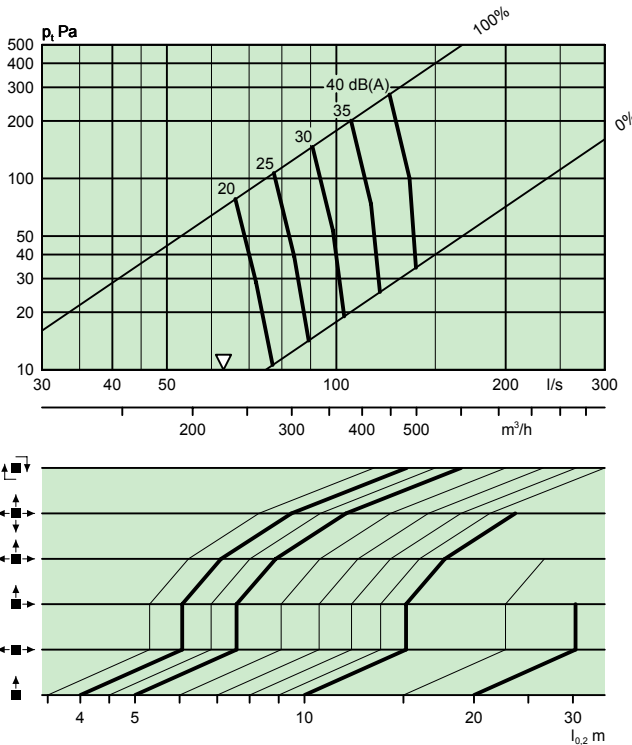

EAGLE CR 315-500 + ALS 250-315 – One step

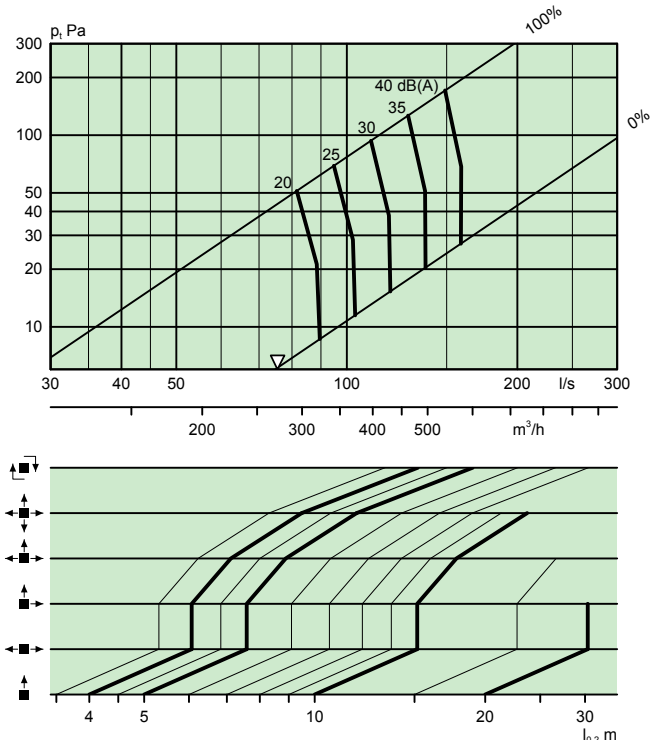

EAGLE CR 315-500 + ALS 200-315 – Two steps

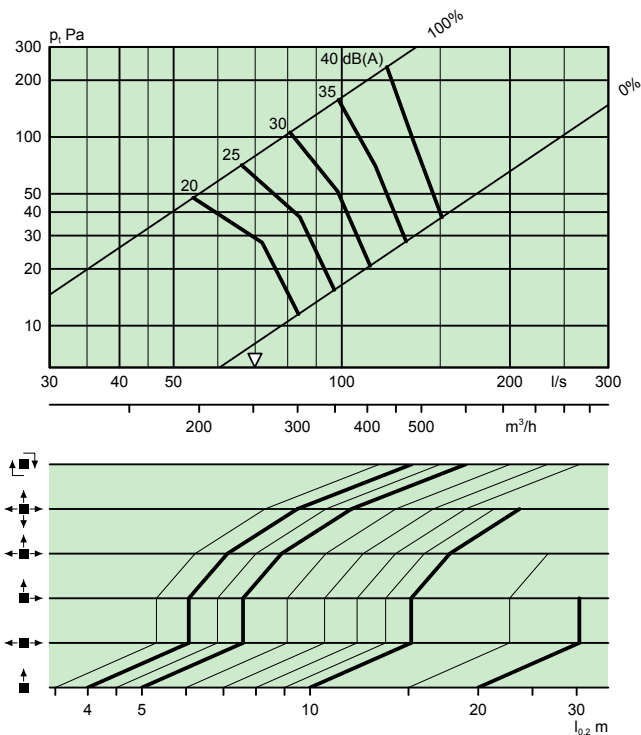

EAGLE CR 315-600 + ALS 200-315 – Two steps

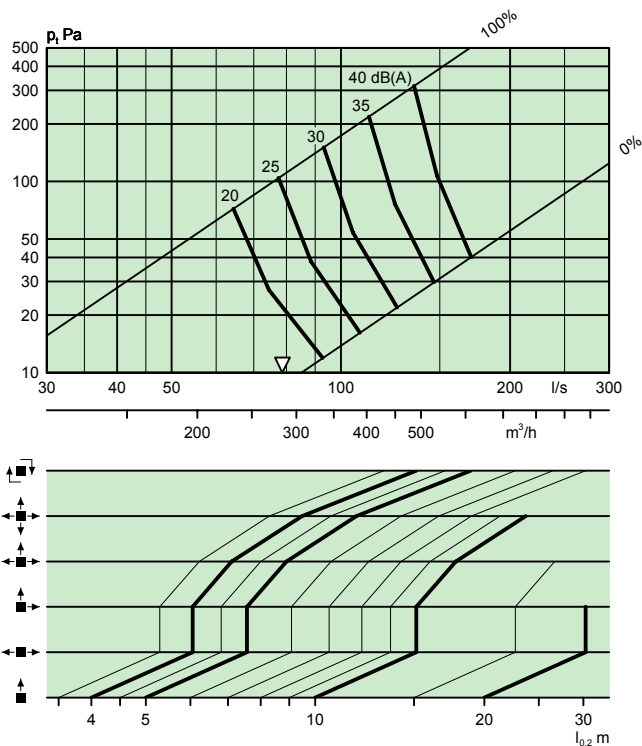

EAGLE CR 315-600 + ALS 250-315 – One step

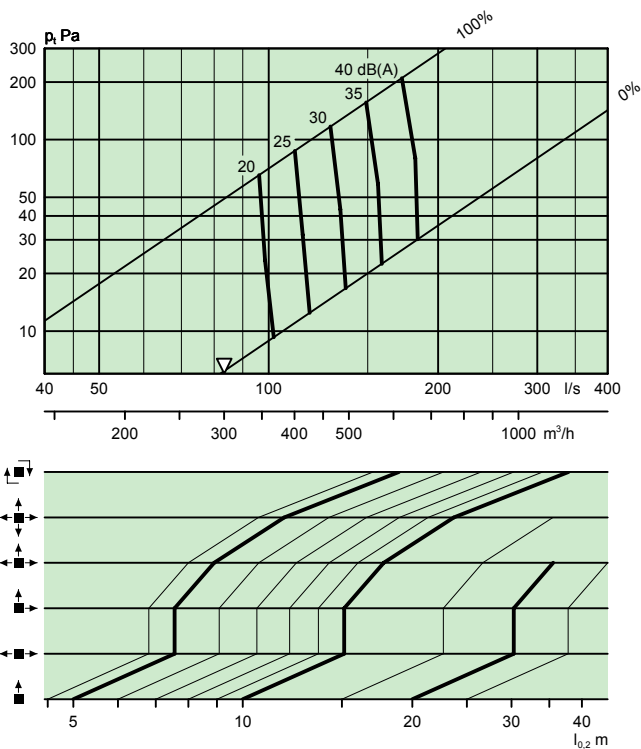

EAGLE CR 400-600 + ALS 315-400 – One step

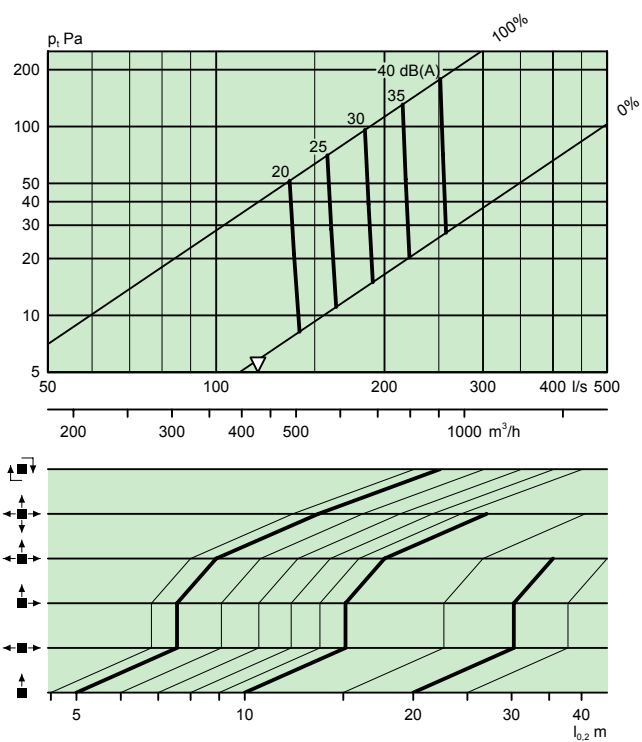

EAGLE CR + ALS: Extract air

Air flow – Pressure drop – Sound level – Throw

- The sound level, dB(A), values are applicable to rooms with an equivalent sound absorption area of 10 m².
- For calculating the width of the air stream, air velocities in the occupied zone or sound levels in rooms with other dimensions, please refer to our web calculation softwares available for download at www.swegon.com

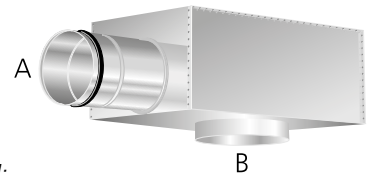

Explanation of the step model:

- One step = One dimensional change between A and B, for example, A = Ø160 mm and B = Ø200 mm.
- Two steps = Two dimensional changes between A and B, for example, A = Ø160 mm and B = Ø250 mm.

EAGLE CR 250-500 + ALS 200-250 – One step

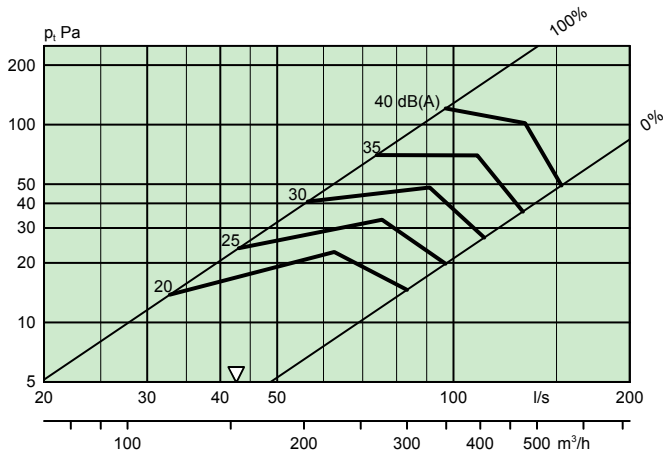

EAGLE CR 315-600 + ALS 250-315 – One step

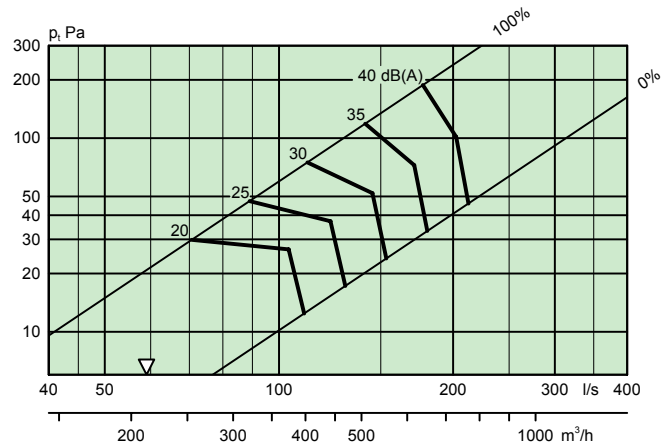

EAGLE CR 250-600 + ALS 200-250 – One step

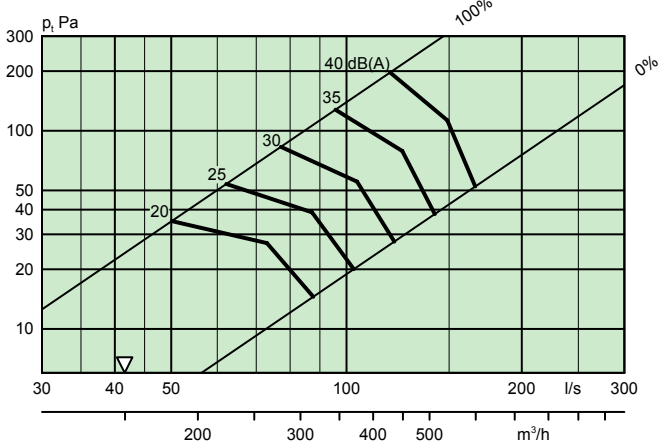

EAGLE CR 400-600 + ALS 315-400 – One step

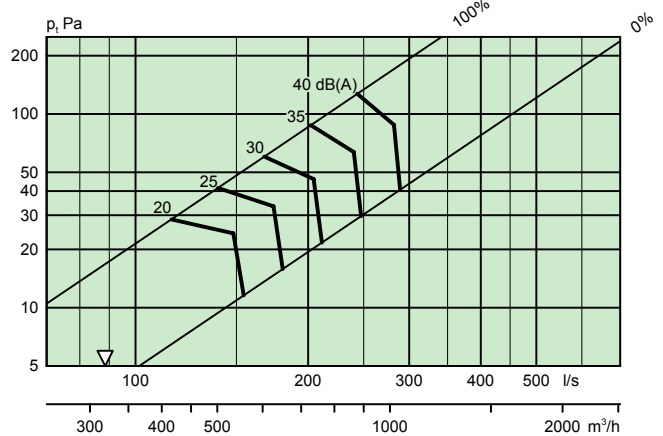

EAGLE CR 315-500 + ALS 250-315 – One step

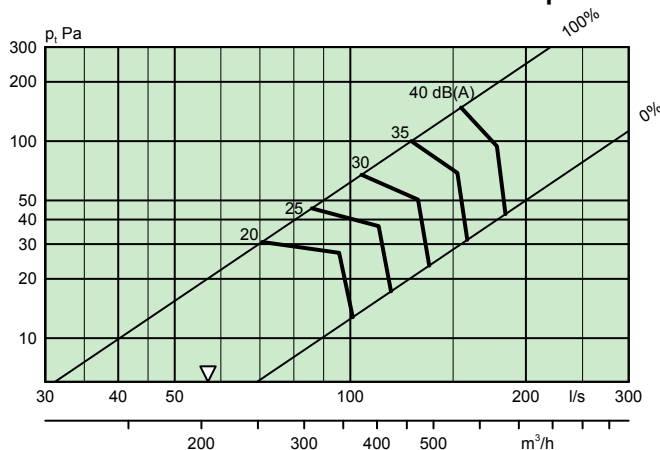

Dimensions and weights

EAGLE Ceiling

Size	A	ØD1	l	M	Weight, kg	No. of nozzles	
						CC	CR
125-400	395	124	375	70	1,7	17	16
125-600	595	124	575	70	3,7	21	16
160-400	395	159	375	70	1,65	25	25
160-600	595	159	575	70	3,6	26	25
200-500	495	199	475	70	2,5	37	36
200-600	595	199	575	70	3,6	37	36
250-500	495	249	475	70	2,5	48	49
250-600	595	249	575	70	3,5	49	49
315-500	495	314	475	70	2,4	48	49
315-600	595	314	575	50	3,5	70	64
400-600	595	399	575	50	3,3	70	81

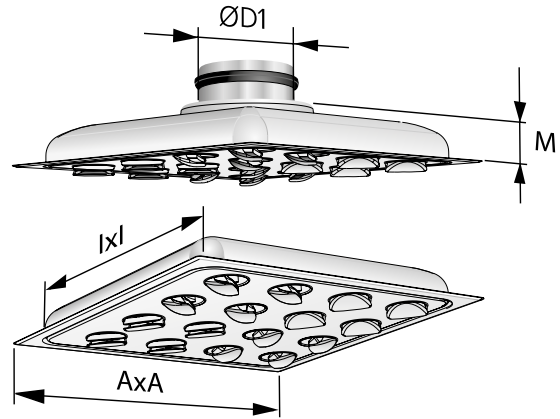

Figure 5. EAGLE Ceiling

Dimensions of opening in ceiling = l x l

EAGLE Ceiling with ALS 1-step

Size	A	B	C	ØD2	Ød	E1	E2	F1	F2	G1	G2	H	K	Weight, kg
125-400	395	282	217	99	125	255	212	113	70	175	132	270	80	3,6
125-600	595	282	217	99	125	255	212	113	70	175	132	270	80	5,6
160-400	395	342	252	124	160	279	236	113	70	188	145	315	80	4,2
160-600	595	342	252	124	160	279	236	113	70	188	145	315	80	6,2
200-500	495	404	288	159	200	314	271	113	70	205	162	375	100	6,0
200-600	595	404	288	159	200	314	271	113	70	205	162	375	100	7,1
250-500	495	504	332	199	250	354	-	113	70	225	182	465	115	7,5
250-600	595	504	332	199	250	354	311	113	70	225	182	465	115	8,5
315-500	495	622	388	249	315	395	-	93	50	230	187	575	140	10,2
315-600	595	622	388	249	315	395	352	93	50	230	187	575	140	11,3
400-600	595	767	488	314	400	455	-	93	-	262	-	712	175	14,6

EAGLE Ceiling with ALS 2-steps

Size	A	B	C	ØD2	Ød	E1	E2	F1	F2	G1	G2	H	K	Weight, kg
160-400	395	342	252	99	160	255	212	113	70	175	132	315	80	3,9
160-600	595	342	252	99	160	255	212	113	70	175	132	315	80	5,8
200-500	495	404	288	124	200	279	236	113	70	188	145	355	80	5,5
200-600	595	404	288	124	200	279	236	113	70	188	145	355	80	6,6
250-600	595	504	332	159	250	314	271	113	70	205	162	450	100	7,7
315-500	495	622	388	249	315	395	-	93	50	230	187	575	140	8,9
315-600	595	622	388	199	315	334	291	93	50	205	162	550	115	10

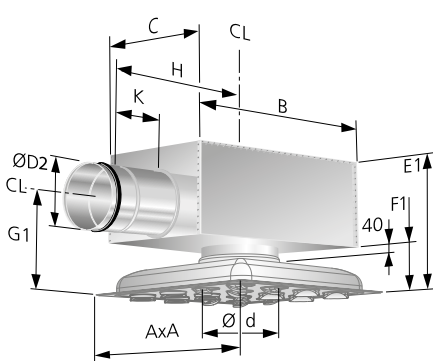

Figure 6. EAGLE CC/CR with ALS.
CL = Centre line

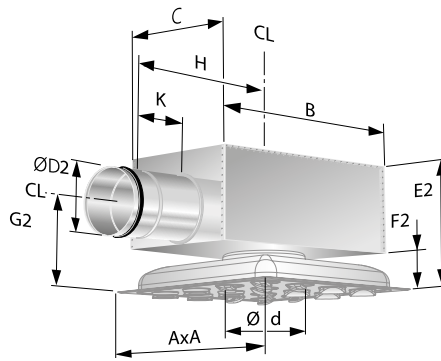

Figure 7. EAGLE CC/CR with ALS.
Low installation height.
CL = Centre line

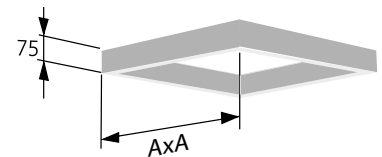

Figure 8. SAR K frame.
When installing size 315-600 and 400-600 diffusers, position the ALS box so that its branch extends 20 mm below the ceiling surface.

Nozzle pattern and nozzle settings

Standard and alternative nozzle settings for various diffusion patterns. NOTE: Air direction in the figure.

Examples, circular nozzle arrangement

Clock-wise swirl (standard)

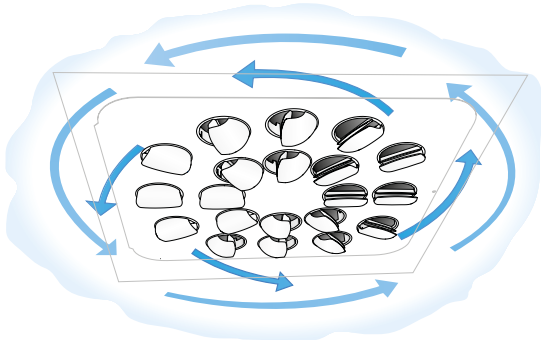

1-way

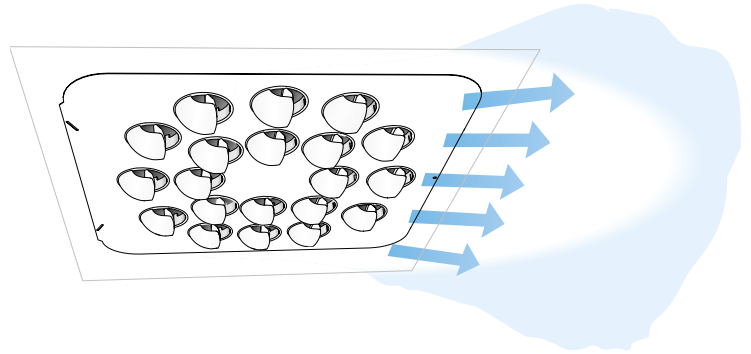

2-way

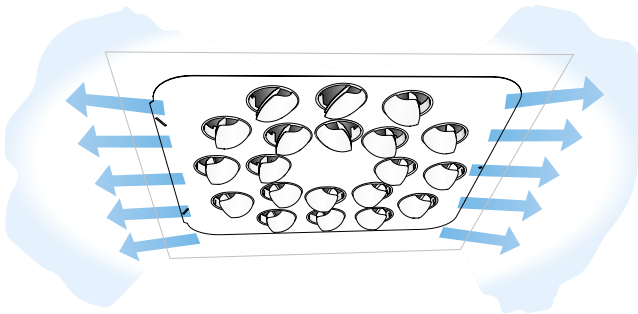

3-way

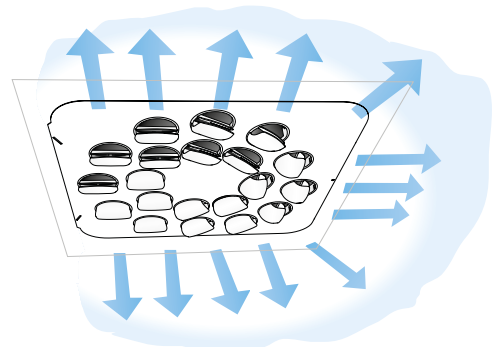

4-way

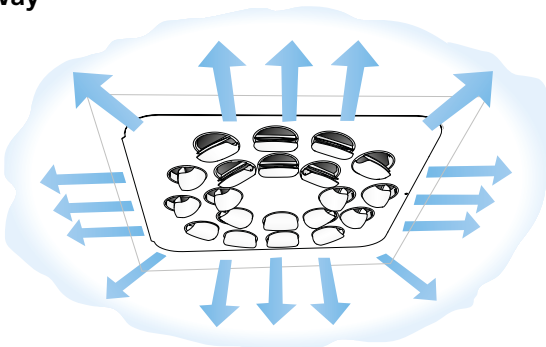

Counter-flow distribution pattern

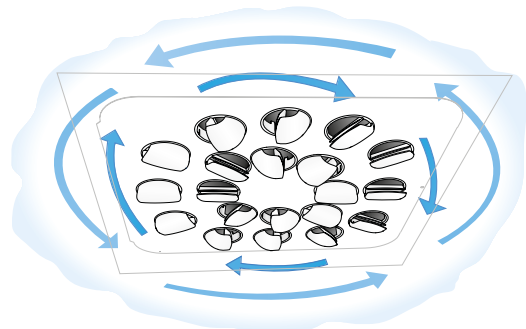

VK Vertical, concentrated

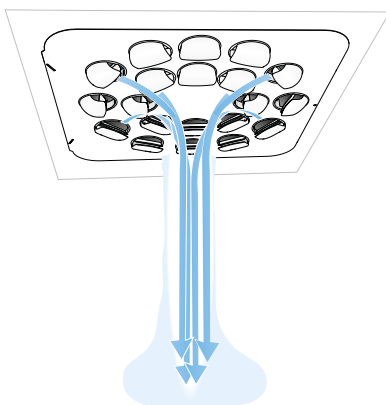

VD Vertical, diffused

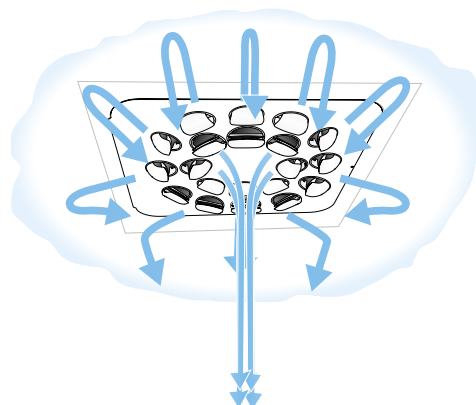

Examples, square nozzle arrangement

Clock-wise swirl (standard)

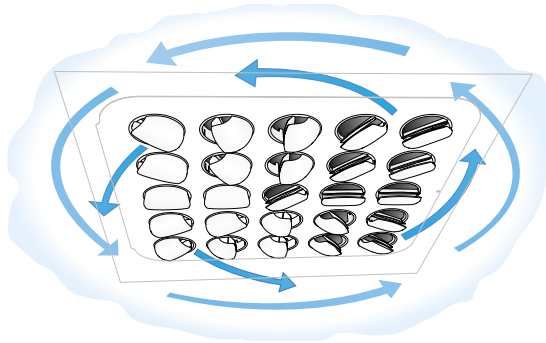

1-way

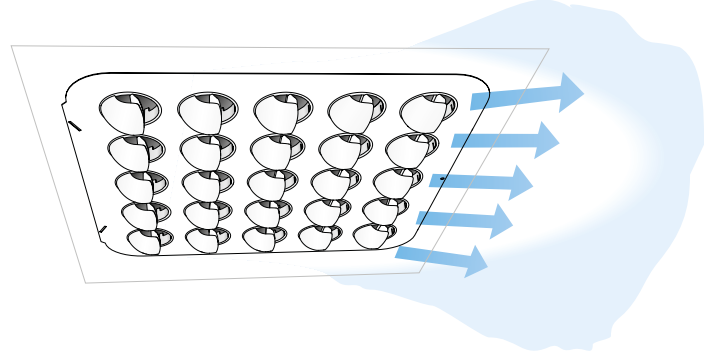

2H-way

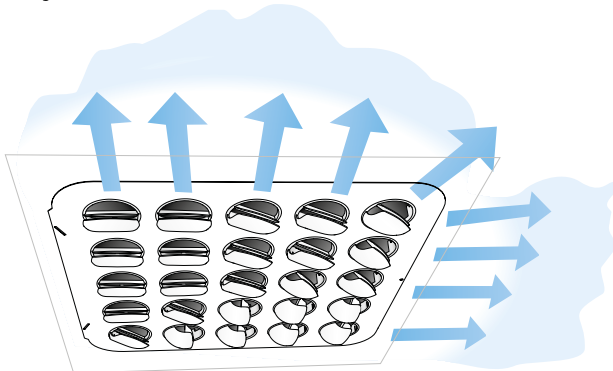

2M-way

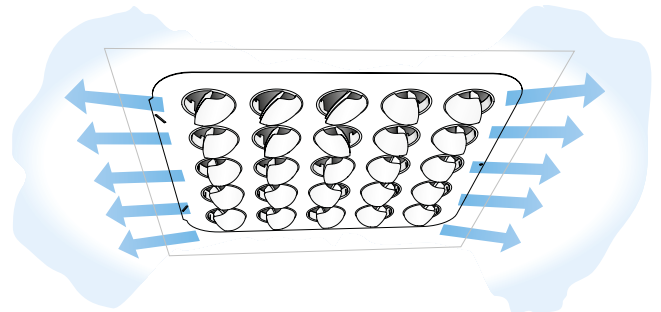

3-way

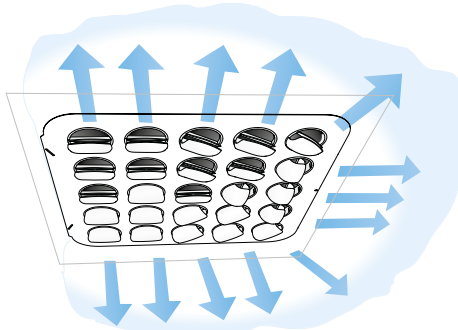

4-way

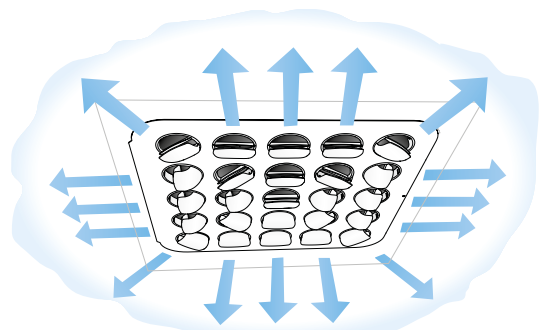

VK Vertical, concentrated

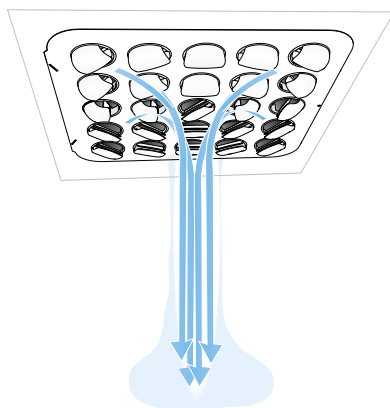

VD Vertical, diffused

