

PELICAN Ceiling HF

Square extract air diffuser



QUICK FACTS

- Perforated air diffuser front face
- Manages large extract airflows
- Flush design
- Designed for modular suspended ceilings
- Quick Access front face
- Can be combined with ALS commissioning box
- Standard colour White RAL 9003
- 5 alternative standard colours
- Other colours upon request

AIR FLOW - SOUND PRESSURE ROOM (Lp10A) *)							
PELICAN CE HF		25 dB(A)		30 dB(A)		35 dB(A)	
Size		l/s	m ³ /h	l/s	m ³ /h	l/s	m ³ /h
160-600		117	421	139	500	165	594
200-600		206	742	244	878	288	1037
250-500		260	936	307	1105	362	1303
250-600		301	1084	356	1282	423	1523
315-500		327	1177	384	1382	450	1620
315-600		393	1415	472	1699	568	2045
400-600		563	2027	660	2376	775	2790
PELICAN CE HF	ALS	25 dB(A)		30 dB(A)		35 dB(A)	
Size	Size	l/s	m ³ /h	l/s	m ³ /h	l/s	m ³ /h
160-600	125-160	23	83	40	144	57	205
200-600	160-200	50	180	70	252	92	331
250-500	200-250	75*	270*	100*	360*	130*	468*
250-600	200-250	78	281	110	396	143	515
315-500	250-315	90*	324*	150*	540*	205*	738*
315-600	250-315	92	331	157	565	211	760
400-600	315-400	153	551	267	961	342	1231

The data is specified for extract air at 50 Pa / *30 Pa total pressure when an ALS commissioning box is used.

*) L_{p10A} = Sound pressure incl. A-filter with 4 dB room attenuation and 10 m² room absorption area.

Contents

Technical description	3
Design	3
Materials and finish.....	3
Accessories	3
Project planning.....	3
Installation	3
Commissioning	3
Maintenance.....	3
Sizing	5
PELICAN Ceiling HF – Air diffuser only	5
PELICAN Ceiling HF + ALS, One step.....	5
PELICAN Ceiling HF + sound attenuator, LD and damper, SP	5
PELICAN Ceiling HF + ALS – Extract air, One step.....	7
PELICAN Ceiling HF + sound attenuator and damper – installation proposals	8
Dimensions and weights	9
Ordering key	10
Specification text.....	10

Technical description

Design

The square PELICAN Ceiling High Flow extract air diffuser consists of a backing box and a perforated air front face. The air front face is hung on hinges on one side and secured by springs on the opposite side. This Quick Access fastening system makes it simpler and quicker to open and close the air front face for installation, commissioning and cleaning.

Materials and finish

The backing box and air front face are made of sheet steel. The connection branch is made of galvanized sheet steel. The interior and exterior surfaces of the air diffuser are painted.

- Standard colour:
 - White semi-gloss, lustre 40, RAL 9003/NCS S 0500-N
- Alternative standard colours:
 - Silver gloss, lustre 80, RAL 9006
 - Grey aluminium gloss, lustre 80, RAL 9007
 - White semi-gloss, lustre 40, RAL 9010
 - Black semi-gloss, lustre 35, RAL 9005
 - Grey semi-gloss, lustre 30, RAL 7037
- Non-painted finish and other colours available on request.

Accessories

Commissioning box:

ALS. The ALS commissioning box is made of galvanized sheet steel and contains a removable commissioning damper, fixed measurement tapping and sound absorbing material*) with reinforced surface layer. Tightness class C on the housing according to SS-EN 12237.

The ALS commissioning box is available with a change in dimension between the inlet and outlet.

*)Fire resistance rated to B-s1,d0 in accordance with EN ISO 11925-2

Frame:

SAR K. For aesthetic installation of a lowered air diffuser.

Adapter:

ADAPTER, for adaptation to various variants and makes of systemized false ceilings: Ecophon, Gyproc, Dampa, etc. Also used for adaptation to optional sizes of lay-in type ceilings, for instance 625 x 625 or 675 x 675. Specification available in separate product sheet for ADAPTER.

Project planning

The PELICAN Ceiling HF is available with square dimensions of 595 x 595 mm in all the connection sizes. This makes the air diffuser very easy to install in modular suspended ceilings with modular dimensions of 600 x 600 mm.

Place the air diffuser onto the T-bar framework, and then secure it to the duct system. See Figure 2.

Installation

To dismantle the front face, insert a thin object, for example a Quick Access card or the equivalent, in between the diffuser face and the diffuser backing box in order to



release the springs. Move the card from the centre out towards the corner, see Figure 1.

The inlet spigot of the air diffuser backing box can be secured to the connecting duct by means of self-tapping screws or a blind rivets. For flush-mounting in fixed ceiling constructions, secure the air diffuser by means of screws into place in the framework through either the sides or top of the backing box.

For mounting in modular suspended ceilings, it is advisable to select air diffusers with outer dimensions of 595 x 595 mm. Position these directly down in the T-bar framework, and then secure them to the duct system or to the commissioning box.

If an ALS commissioning box is used, it must be secured to the building structure by means of hangers or mounting brackets.

The distance between the commissioning box and the air diffuser can be increased by as much as 500 mm without having to lengthen the measuring tubes and damper adjustment cords. See Figure 2.

Commissioning

Commissioning should be carried out with the front face mounted. Pull the measuring tubes and damper adjustment cords out through the front face. Then connect the manometer to the correct measuring tube. Always use the transparent tube for extract air. The rated coefficient of performance of the air diffuser can be used in a calculation to determine the required commissioning pressure. Conclude commissioning by adjusting the damper to the correct blade position, tie a commissioning knot in the damper cords to indicate the damper position.

Measurement accuracy and requirement on straight duct before the commissioning box, see Figure 2. The requirements of straight duct depends on the type of disturbance before the commissioning box. Figure 2 shows a bend, a dimensional change and a T-piece. Other types of disturbances requires at least 2xD straight (D = connection dimension) for measurement accuracy of $\pm 10\%$ of the flow.

The rated coefficient of performance (K-factor) is specified on the identification label of the product and in the relevant commissioning instructions at www.swegon.com.

Maintenance

The air diffuser can be cleaned, if necessary, using lukewarm water with dishwashing detergent added or by vacuum cleaning using a brush nozzle. The duct system can be reached for cleaning after opening the front face. If a type ALS commissioning box is used, swing the front face to the side on its hinges so that you then can grip the handle of the tubular damper casing and rotate it out of its holder. See Figure 3.

PELICAN Ceiling HF

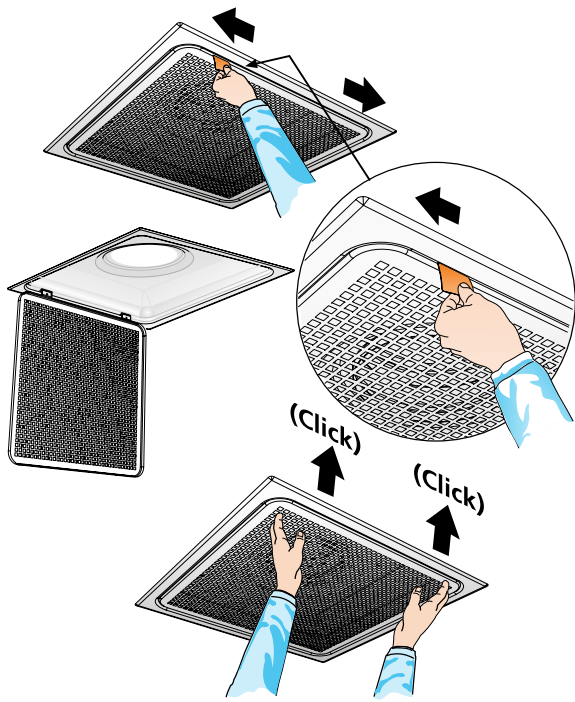

Figure 1. Quick Access.

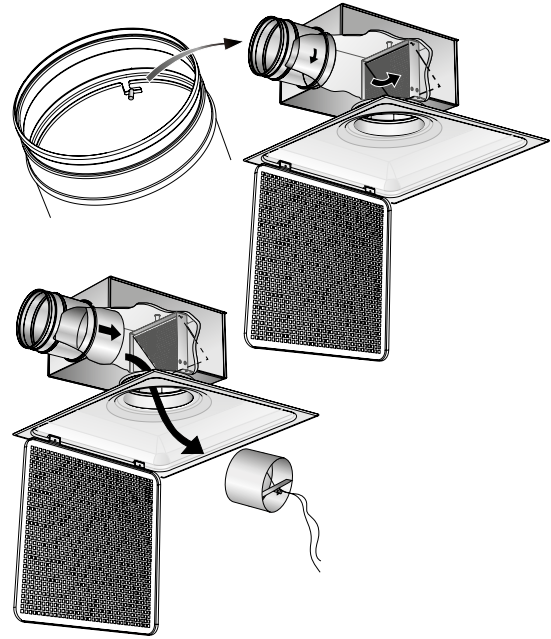

Figure 3. To dismantle the damper.

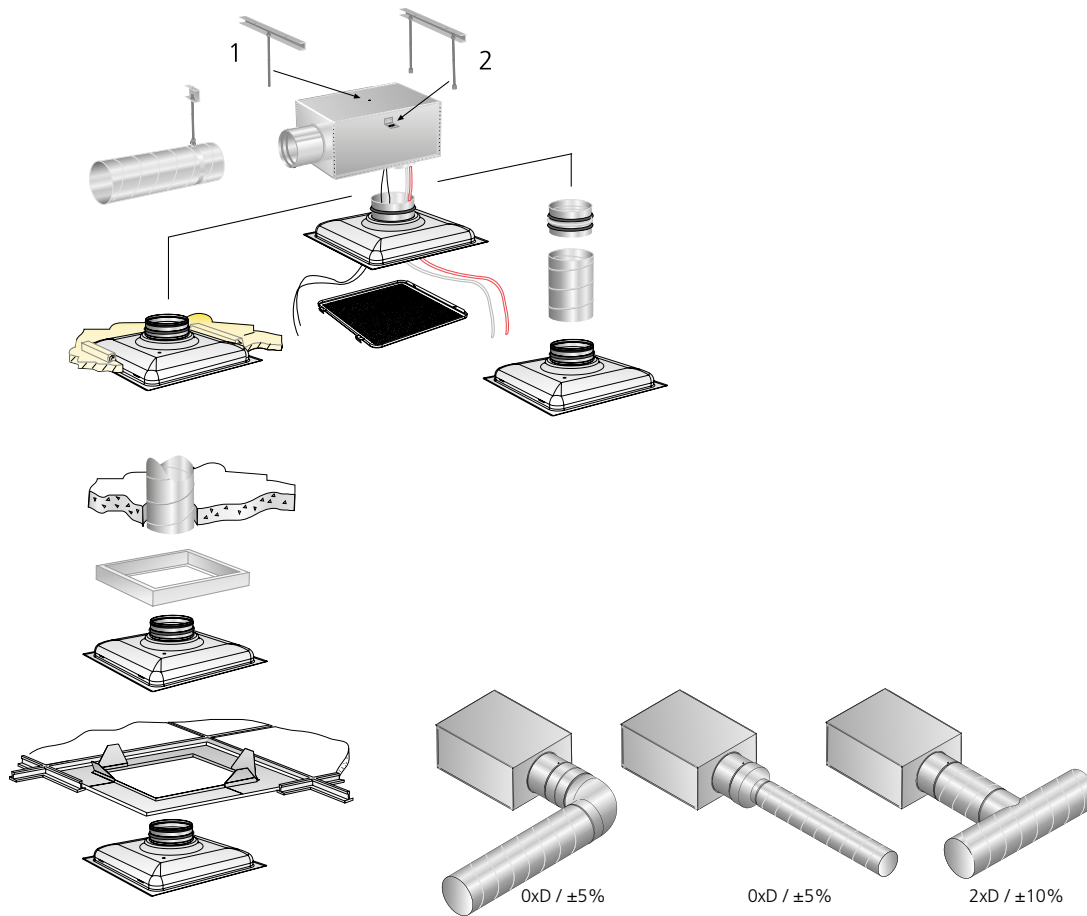

Figure 2. Installation alternatives.

Sizing

- Sound pressure level dB(A) applies to rooms with 10 m² equivalent sound absorption area.
- Sound attenuation (ΔL) below is shown in the octave band. Orifice attenuation is included in the values.
- To calculate the sound levels in rooms with other dimensions, please refer to our web software, which can be found at www.swegon.com.

L_w = Sound power level

L_{p10A} = Sound pressure level dB (A)

K_{ok} = Correction for producing the L_w value in the octave band

$L_w = L_{p10A} + K_{ok}$ gives the frequency divided octave band

Acoustic data – Extract air

PELICAN Ceiling HF – Air diffuser only

Sound power level L_w (dB)

Table K_{ok}

Size	Mid-frequency (Octave band) Hz							
	63	125	250	500	1000	2000	4000	8000
PELICAN CE HF	63	125	250	500	1000	2000	4000	8000
160-600	-8	4	9	2	-7	-13	-20	-24
200-600	-2	5	7	3	-4	-8	-15	-22
250-600	-1	6	5	3	-3	-6	-15	-21
315-600	-1	2	1	-1	0	-2	-9	-11
400-600	3	1	2	-1	0	-2	-12	-20
Tol. ±	2	2	2	2	2	2	2	2

Sound attenuation ΔL (dB)

Table ΔL

Size	Mid-frequency (Octave band) Hz							
	63	125	250	500	1000	2000	4000	8000
PELICAN CE HF	63	125	250	500	1000	2000	4000	8000
160-600	20	13	8	4	3	1	1	0
200-600	18	11	6	3	2	1	0	0
250-600	16	10	5	2	1	1	0	0
315-600	14	8	4	1	1	0	0	0
400-600	13	8	4	1	0	0	0	0
Tol. ±	2	2	2	2	2	2	2	2

PELICAN Ceiling HF + ALS, One step

Sound power level L_w (dB)

Table K_{ok}

Size	Mid-frequency (Octave band) Hz							
	63	125	250	500	1000	2000	4000	8000
PELICAN CE HF	63	125	250	500	1000	2000	4000	8000
160-600	-1	9	7	-1	-7	-7	-11	-17
200-600	-2	7	4	-4	-6	-6	-12	-19
250-600	0	10	3	-4	-5	-7	-12	-20
315-600	0	8	3	-2	-2	-6	-15	-19
400-600	8	11	4	0	-2	-6	-12	-19
Tol. ±	2	2	2	2	2	2	2	2

Sound attenuation ΔL (dB)

Table ΔL

Size	Mid-frequency (Octave band) Hz							
	63	125	250	500	1000	2000	4000	8000
PELICAN CE HF	63	125	250	500	1000	2000	4000	8000
160-600	22	14	10	17	19	12	10	12
200-600	19	11	8	16	18	12	11	11
250-600	16	8	8	16	17	12	12	13
315-600	14	6	7	19	14	10	10	13
400-600	14	5	8	14	11	10	11	12
Tol. ±	2	2	2	2	2	2	2	2

PELICAN Ceiling HF + sound attenuator, LD and damper, SP

Sound power level L_w (dB)

Table K_{ok}

Size	Mid-frequency (Octave band) Hz							
	63	125	250	500	1000	2000	4000	8000
PELICAN CE HF	63	125	250	500	1000	2000	4000	8000
Comb. 1	17	17	4	-1	-6	-11	-12	-20
Comb. 2	16	12	2	-2	-3	-5	-9	-12
Comb. 3	12	9	0	-1	-2	-4	-8	-11
Tol. ±	2	2	2	2	2	2	2	2

Sound attenuation ΔL (dB)

Table ΔL

Size	Mid-frequency (Octave band) Hz							
	63	125	250	500	1000	2000	4000	8000
PELICAN CE HF	63	125	250	500	1000	2000	4000	8000
Comb. 1	See corresponding product: CLA and CRM.							
Comb. 2								
Comb. 3								
Tol. ±	2	2	2	2	2	2	2	2

K_{ok} for Comb 1-3 is applicable with CRM and CLA.

LD = CLA sound attenuator, SP = CRM damper

See also figures on page 7.

Comb. 1 = LD-SP-315 + PELICAN CE HF 2 x 250-600

Comb. 2 = LD-SP-400 + PELICAN CE HF 2 x 315-600

Comb. 3 = LD-SP-400 + PELICAN CE HF 400-600

Sizing diagram

- Sound level dB(A) applies to rooms of 10 m² equivalent sound absorption area.
- To calculate the sound levels in rooms with other dimensions, please refer to our ProAir web software, which can be found at www.swegon.com.

PELICAN Ceiling HF – Extract air

Airflow – Pressure drop – Sound level

- The diagrams illustrate data for the PELICAN Ceiling HF recessed in a ceiling.
- The diagrams should not be used for commissioning.
- The dB(A) values are for rooms with normal acoustic absorption (4 dB room attenuation).
- The dB(C) value is normally 6-9 dB higher than the dB(A) value.

PELICAN CE HF – Overview diagram, size 600x600

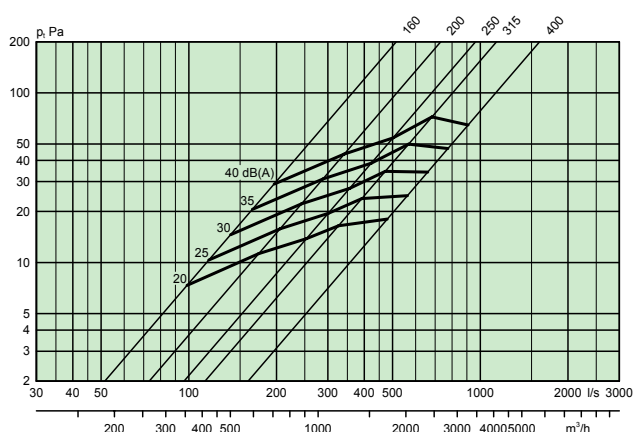

PELICAN CE HF 250-500, 315-500

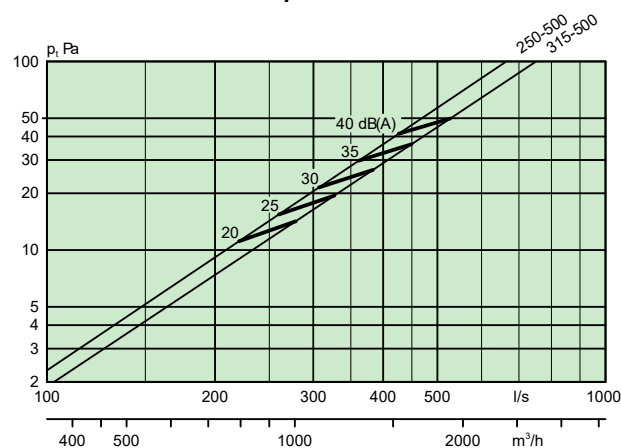

PELICAN Ceiling HF + ALS – Extract air, One step

Airflow – Pressure drop – Sound level

- ▽ = Min. airflow required for obtaining sufficient commissioning pressure.

PELICAN CE HF 250-600 + ALS 200-250 – One step

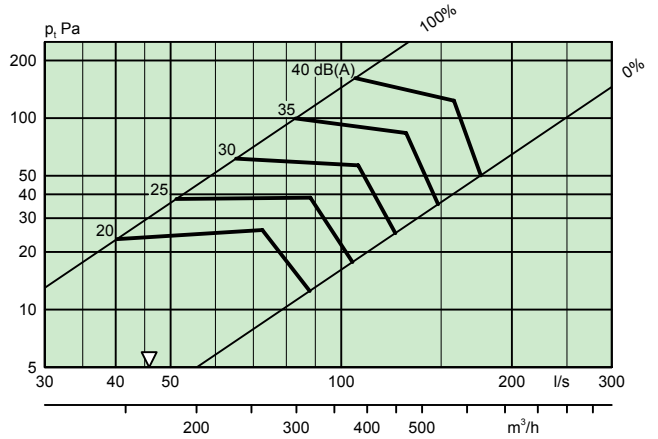

PELICAN CE HF 160-600 + ALS 125-160 – One step

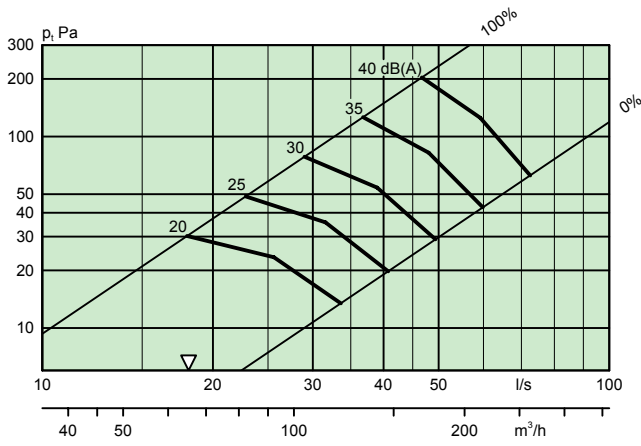

PELICAN CE HF 315-500 + ALS 250-315 – One step

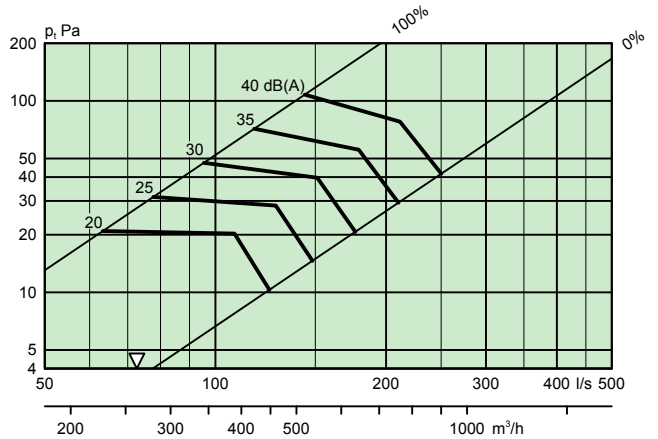

PELICAN CE HF 200-600 + ALS 160-200 – One step

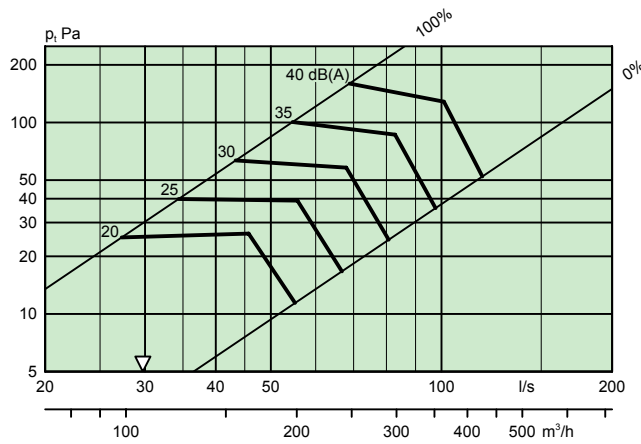

PELICAN CE HF 315-600 + ALS 250-315 – One step

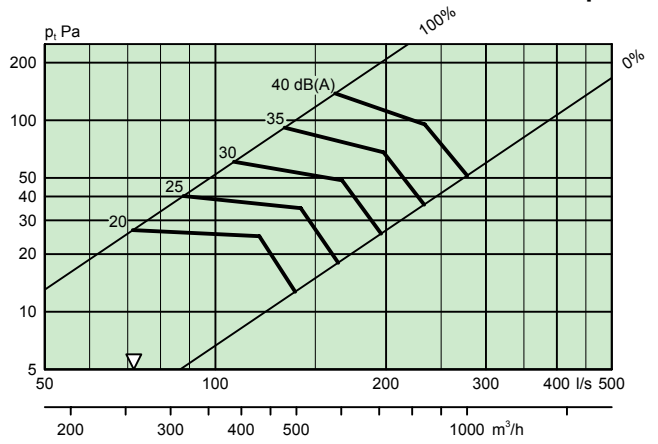

PELICAN CE HF 250-500 + ALS 200-250 – One step

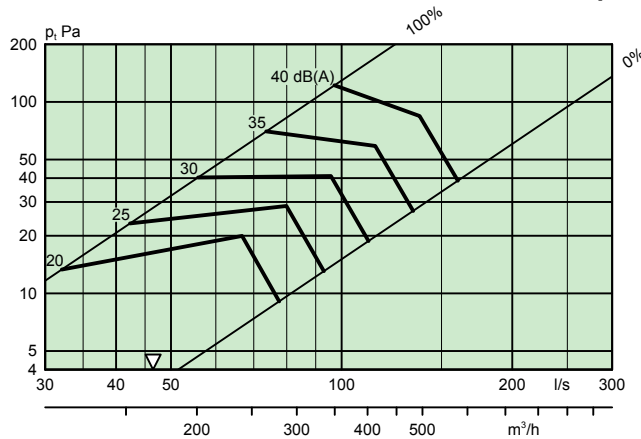

PELICAN CE HF 400-600 + ALS 315-400 – One step

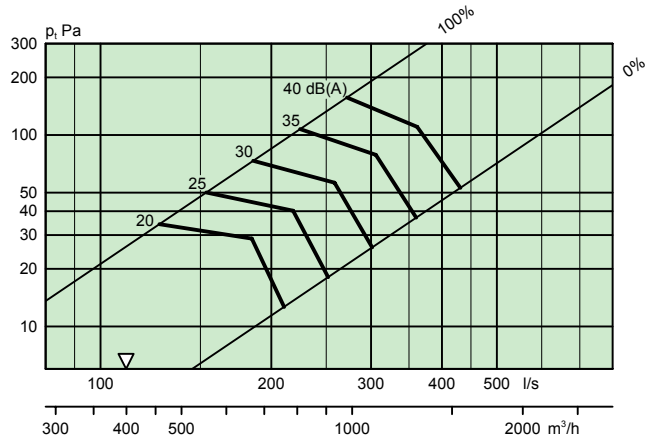

PELICAN Ceiling HF + sound attenuator and damper – installation proposals

Airflow – Pressure drop – Sound level

- Sound level dB(A) applies to rooms of 10 m² equivalent sound absorption area.
- ∇ = Min. airflow required for obtaining sufficient commissioning pressure.
- To calculate the sound levels in rooms with other dimensions, please refer to our ProAir web software, which can be found at www.swegon.com.

Combination 1: PELICAN Ceiling HF 2x250-600 with CLA 315 and CRM 315

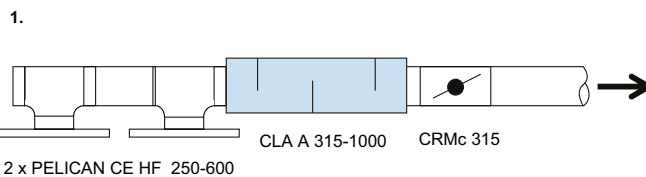
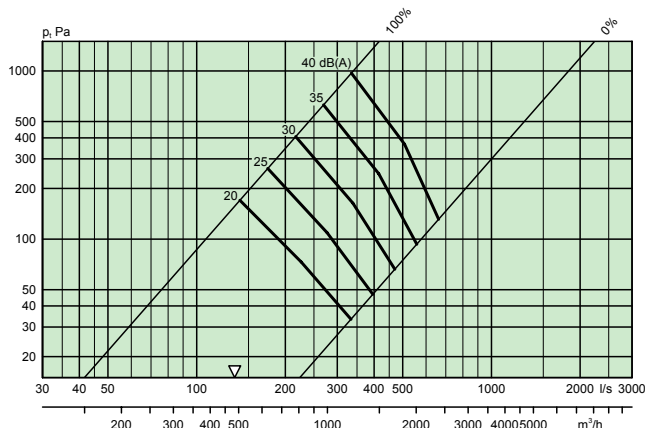

Combination 2: PELICAN Ceiling HF 2x315-600 with CLA 400 and CRM 400

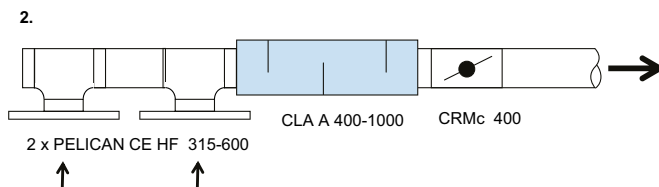
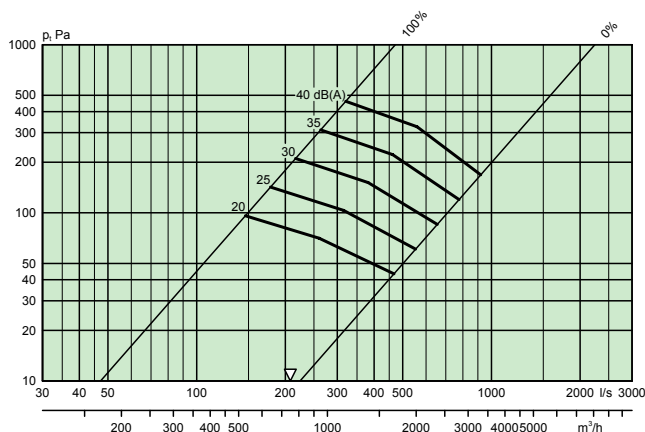

Combination 3: PELICAN Ceiling HF 400-600 with CLA 400 and CRM 400

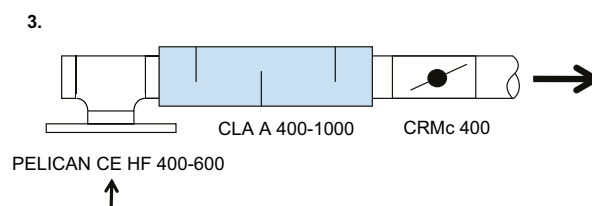
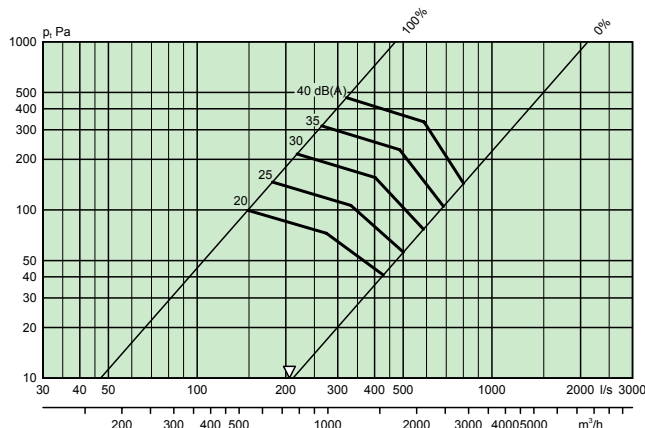

Dimensions and weights

PELICAN Ceiling HF

Size	Dimensions (mm)				Weight (kg)
	A	Ød	l	M	
160-600	595	159	575	70	3.1
200-600	595	199	575	70	3.1
250-500	495	249	475	70	3,4
250-600	595	249	575	70	3.1
315-500	495	314	475	70	3,4
315-600	595	314	575	50	3.1
400-600	595	399	575	50	2.9

Dimensions of opening in ceiling = l x l
CL = Center line

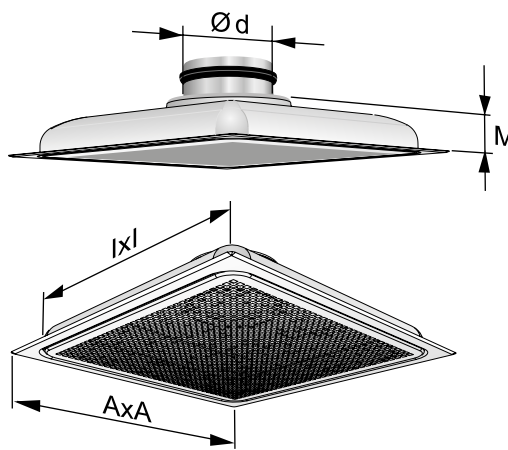

Figure 4. PELICAN Ceiling HF

PELICAN Ceiling HF + ALS – One step

Size	Dimensions (mm)											Weight (kg)
	A	B	C	ØD	Ød1	E	F	G	H	J	K	
160-600	595	342	252	124	160	279	113	188	315	40	80	6.2
200-600	595	404	288	159	200	314	113	205	375	40	100	7.0
250-500	495	504	332	199	250	354	113	225	465	40	115	8,2
250-600	595	504	332	199	250	354	113	225	465	40	115	8.7
315-500	495	622	388	249	315	395	93	230	575	40	140	11,8
315-600	595	622	388	249	315	395	93	230	575	40	140	11.8
400-600	595	767	488	314	400	455	93	262	712	40	175	15.0

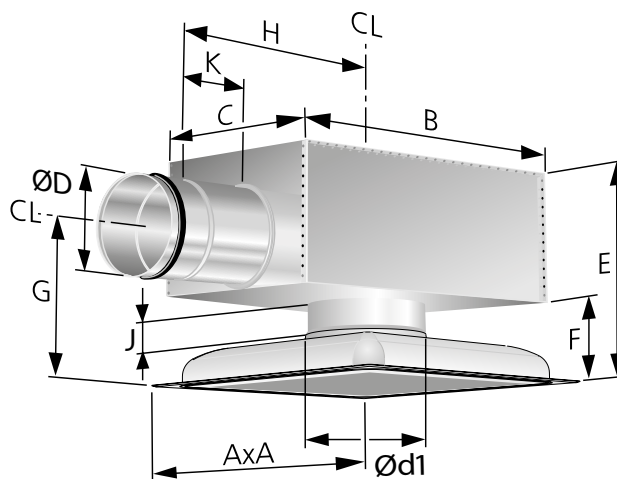

Figure 5. PELICAN Ceiling HF with ALS. CL = Centerline.

SAR K – Frame

Size	Dimensions (mm)		Weight (kg)
	L	N	
500	495	75	1
600	595	75	1

When installing size 315-600 and 400-600 air diffusers, position the ALS box so that its branch extends 20 mm below the ceiling surface.

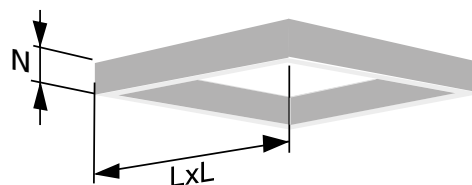

Figure 6. SAR K frame.

