

PARASOL Zenith

4-way distribution comfort module



QUICK FACTS

- High performance 4-way distribution comfort module with cooling, heating and ventilation
- Large span between the lowest and highest air flow
- Few variants for easier sizing and variable air flow control
- Optimised for low energy consumption
- Manages high air flow at low driving pressure
- Easy installation on account of low weight, compact dimensions and optional air connections on short or long sides
- Hygiene design as an option for hospital applications
- Quick bracket for time saving installation
- Can be integrated in the WISE-system
- Upgradable from CAV to VAV
- For suspended mounting, a design kit and a coanda frame are available as accessories

Variant		Supply air			Performance	
Size	Air connection	Pa*	l/s	m ³ /h	Total cooling capacity (W)**	Sound level (dB(A))
600	125	75	20	72	493	26
600	125	75	25	90	564	28
600	125	75	30	108	631	30
600	160	75	25	90	566	27
600	160	75	35	126	697	30
600	160	75	45	162	809	33
1200	125	75	25	90	882	26
1200	125	75	35	126	1077	28
1200	125	75	45	162	1218	30
1200	160	75	30	108	900	23
1200	160	75	60	216	1375	28
1200	160	75	80	288	1591	34
1800	200	75	60	216	1590	30
1800	200	75	80	288	1890	33
1800	200	75	100	360	2135	35

*Total pressure duct (Pa)

**Air: $\Delta T_f=7K$ / Water: $\Delta T_{mk}=8.5K$, $t_{water}=14/17^\circ C$

Contents

Advantages with PARASOL Zenith	3
Technical description	4
Comfort module PARASOL Zenith	4
Range of application	4
Market-based module dimensions	4
Design	4
Accessories for suspended mounting	4
Function	5
Control variants	7
Large working range	8
Comfort guarantee	9
Hygienic design	10
Alternative air connections	11
Easily accessible water connections	11
Installation - Details	12
Suspension	12
Connections	13
Water	13
Air	13
Commissioning	14
Technical data	15
Recommended limit values	15
Cooling	16
Heating	17
Selectable control variants and accessories	20
Factory mounted accessories for integration in the WISE system	21
Factory-fitted accessories	22
Loose accessories	23
Loose accessories	24
Complete kit for upgrade to the WISE system	25
Dimensions and weights	26
Specification	27
Contractor demarcation	27
Available to order	27
Ordering key - Product	28
Specification text	29



Advantages with PARASOL Zenith

The list below shows a few of the benefits enjoyed by the consultant, architect, installer and user

The Consultant appreciates

- Energy efficient product - high cooling capacity at low driving pressure
- Few variants with large application area – Large span regarding minimum to largest air flow
- Available in three sizes 600, 1200 and 1800
- High comfort irrespective of room placement – Easy to adapt to the direction for optimal room comfort both initially and in the event of future changes to the floor plan
- Easy planning through alternative air connections – choose short or long side connection
- Variable air flow control minimises variants and simplifies selection

The Architect appreciates

- Face plate always at the same level as the suspended ceiling, irrespective of operating mode
- Space efficient – takes up very little ceiling space
- Numerous options with different colours

The Installer appreciates

- Lowest weight on the market – simpler and more ergonomic handling
- Compact dimensions - can often be installed in existing roof system, without the need of dismantling this
- Possibility of air connection on the short side - faster installation with less material usage
- Easily accessible water connections - access with press coupling tool
- Easier commissioning - select factory setting k-factor or adjustment on site
- Stock products - pressed for time? Quick deliveries and easy k-factor setting with the help of a single knob

The User appreciates

- Low energy consumption - high capacity at low driving pressure
- High comfort - double outlet provides improved Coanda effect even at low pressure
- 4-way air distribution ensures very good mixing
- ADC air deflector - change the air flow pattern as required for each side
- Low sound levels

Technical description

Comfort module PARASOL Zenith

The new generation of Parasol Zenith features variable air flow control, which makes selection easier, fewer variants and simplified logistics on site in addition to greater flexibility and simplicity in terms of future rebuilding work and customisation.

The increased cooling capacity also enables a lower duct pressure or a higher cooling water temperature can be used, which saves energy and even improves room comfort further.

PARASOL Zenith is available in the following variants:

Variant A: Supply air and waterborne cooling, (600, 1200 and 1800)

Variant B: Supply air, waterborne cooling and heating (600, 1200 and 1800)

Installation: Flush mounting for suspended ceilings

Range of application

Parasol Zenith is ideal for use as a standard application in such premises as:

- Offices and conference rooms
- Classrooms
- Hotels
- Restaurants
- Hospitals
- Shops
- Shopping centres

Market-based module dimensions

The order range includes module dimensions to fit the standardised ceiling measurement c-c 600, 625 and 675 mm. In addition, there is a mounting frame for drywall ceilings and ceiling solutions of the clip-in-type, for example, Dampa and FineLine. In order to guarantee a good fit in T-bar systems, we recommend T sections with a width of 24 mm.

Design

The face plate of the Parasol Zenith is always “flush”, i.e. always in line with the suspended ceiling which gives a stylish and discreet installation. The double outlets means that there is no need to lower the face plate for high air flow rates, maximum capacity (induction) is still achieved.

Accessories for suspended mounting

For suspended mounting, a design kit and a coanda frame are available as optional accessories if desired. The design kit and the coanda frame are available in three sizes – 600, 1200 and 1800 – and for air connection on all sides and for dimensions 125, 160 and 200. Both accessories can be ordered in Swegon’s standard colours and be ordered individually.

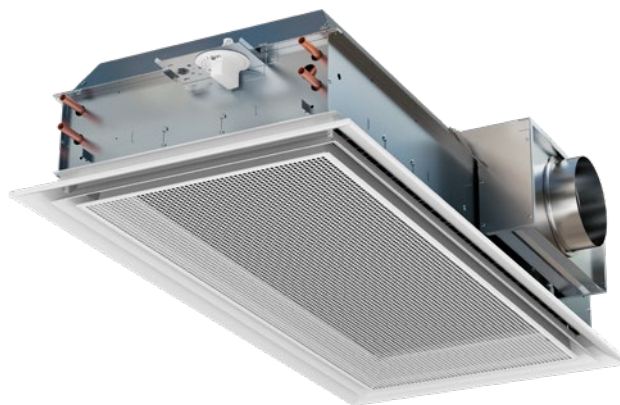

Figure 1. Product image (PARASOL Zenith 1200)

Colour

The product, as well as the design kit and coanda frame, are painted as standard in our standard colour RAL 9003 signal white, gloss ratio 30 ± 6%.

The product, as well as the design kit and coanda frame, can also be ordered in the following colours.

RAL 7037 dusty grey, gloss ratio 30-40%

RAL 9010 pure white, gloss ratio 30-40%

RAL 9005 jet black, gloss ratio 30-40%

RAL 9006 white aluminium, gloss ratio 70-80%

RAL 9007 grey aluminium, gloss ratio 70-80%

The product, as well as the design kit and coanda frame, can also be ordered in different colours.

Special types

On request, the product, as well as the design kit and coanda frame can also be obtained with e.g.:

- Optional colour or relief finish paint.
- Face plate with different perforation pattern

For further particulars about special types, get in touch with your nearest Swegon representative.

Function

Parasol Zenith is a 4-way air discharge comfort module with induction function. Exactly as in a climate beam, the supply air is used to operate the cooling and heating function of a central air handling unit and therefore does not include an integrated fan or other moving parts. This gives very quiet operation and minimal maintenance requirements. Unlike a 2-way air discharge climate beam, air distribution to the room occurs from all 4 sides of the unit, which means as large areas of the ceiling as possible are used to spread the air, thus ensuring comfort in the occupied zone.

PARASOL Zenith has variable k-factor setting and large air flow range. The product is available both as a CAV product with fixed k-factor and is easy to upgrade to a VAV function with the help of different accessories. It is also possible to order as a AWC variant from the factory fitted with control or actuator for air flow control (0-10 V) (see PARASOL Zenith AWC).

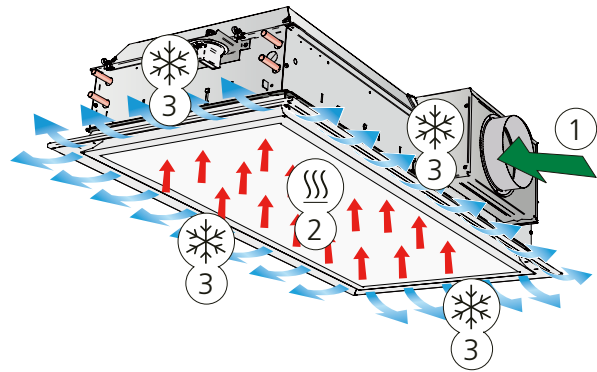

Figure 2. Variant A: Cooling and supply air function
 1 = Primary air
 2 = Induced room air
 3 = Primary air mixed with chilled room air

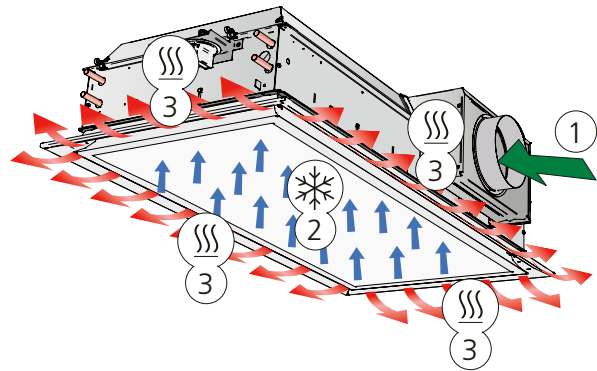

Figure 3. Variant B: Heating and supply air function
 1 = Primary air
 2 = Induced room air
 3 = Primary air mixed with heated room air

Induction principle

Primary air (A) from the air handling unit provides Zenith PARASOL with supply air via a supply air duct and builds up positive pressure in the unit's plenary.

The supply air is forced out at high speed through small slots (B). The high speed means that the surrounding air is drawn in and mixed with supply air, which generates negative pressure above the unit's integrated heat exchanger (C). Room air (D) is continuously drawn up from the room through the water-based heat exchanger where, if necessary, it is cooled or heated before it mixes with the supply air.

The mixed air is then distributed to the room via aerodynamically designed outlets. The outlets are designed to ensure that the distributed air follows the suspended ceiling by utilising the so-called Coanda effect (E). The supplied air is then mixed with additional room air, which further lowers the air velocity and lessening the temperature difference before it reaches the occupied zone.

The proportion of recirculated room air drawn through the heat exchanger is typically about 3-5 times the proportion of primary air, i.e. if 20 l/s supply air comes from the air handling unit, then approximately 60-100 l/s room air will pass through the exchanger and be tempered.

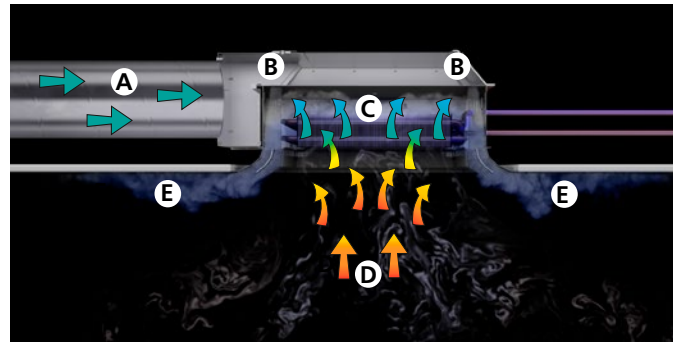

Figure 4. Induction principle in Parasol Zenith

Condensation-free cooling

Parasol Zenith has been developed to work condensation-free and therefore requires no drainage system or filter. Normally inlet temperatures between 14-16 °C are used for the cooling water.

High comfort – today and tomorrow.

A good indoor climate is characterized by good air quality and the correct room temperature without draughts and noise. Different requirements are made on air flow, cooling capacity and heating capacity depending on the type of building in question and how this will be used.

As greater demands are made on being able to offer customised office solutions and to easily change the floor layout for new or existing tenants if changed needs arise, it is important to take this into consideration as early as the design phase. As this will minimise future costs for rebuilding. Regardless of the scenario, new Parasol Zenith gives - through its simplicity in terms of air flow range, operation and commissioning - all the possibilities to find this flexible and optimal solution.

Control variants

Parasol Zenith provides unique advantages with its slot control and through this a large working range on the air side.

Parasol Zenith is designed to handle a large air flow range in one and the same product. This gives benefits such as easy sizing and a straightforward product upgrade path.

The constant flow product PARASOL Zenith has quick and easy adjustment with the help of a knob.

PARASOL Zenith is available in two other designs:

- WISE Parasol Zenith for the WISE II system
- PARASOL Zenith AWC for stand-alone applications

For more information, see the product sheets WISE Parasol Zenith and PARASOL Zenith AWC on www.swegon.com.

You can also integrate PARASOL Zenith as a pure CAV product (without motorised damper function) in the WISE system. This is done by choosing a WISE CU as a fitted accessory. This gives additional flexibility to use wireless technology and at the same time future-proof the product. With the help of our upgrade kits, the product can subsequently be upgraded with a motor and e.g. face plate with presence sensor and then turn into a WISE Parasol Zenith with variable motorised control of the air flow.

Read more about our upgrade kits on page 25.

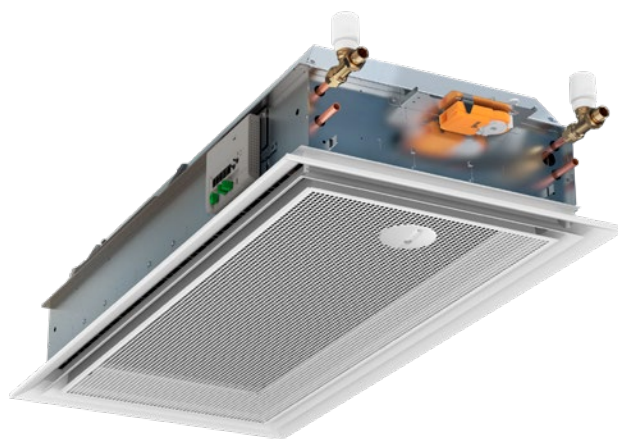

Figure 5. WISE Parasol Zenith.

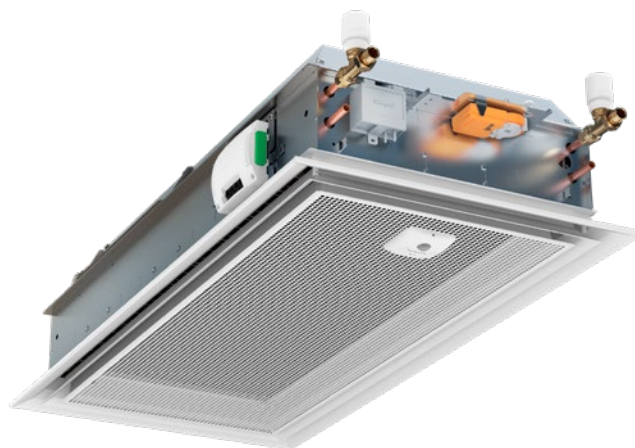

Figure 6. PARASOL Zenith AWC.

Large working range

The work area related to the smallest to the largest air flow in one and the same product is very large for Parazol Zenith. In practice this means that one and the same product can handle a variety of room types, by being adjusted as required. The large work area is made possible by Parazol Zenith being equipped with slots for versatile and easy air flow adjustment. This also gives the following advantages:

- Fewer variants through larger air flow range/k-factor area
- Products with easy k-factor setting on site for quick start of the build
- Simple commissioning

In order to clarify the large work area of PARASOL Zenith, we can compare the curves for cooling capacity/air flow with the cooling requirements for seven different types of rooms:

- A+B Individual office room (1 person)
- C+D Office for customer visits (3 people)
- E, F, G, H Conference room (4, 6, 8, 12 people)

The individual office and the office for customer visits are assumed to be placed at the façade, while the conference room is assumed to be placed on the floor's inner zone.

In the diagram, we can see that the product variants can handle all types of rooms. All that is required is to adjust the slot openings as required.

You can also see that the products can give a higher cooling capacity than the demand. This allows several options:

- Use the full capacity to quickly correct the deviations in room temperature
- Lower the driving pressure in the supply air duct and save fan energy
- Increase the supply flow temperature of the cooling water and save energy (chiller)

Total cooling capacity, air and water

Diagram 1: Capacity range

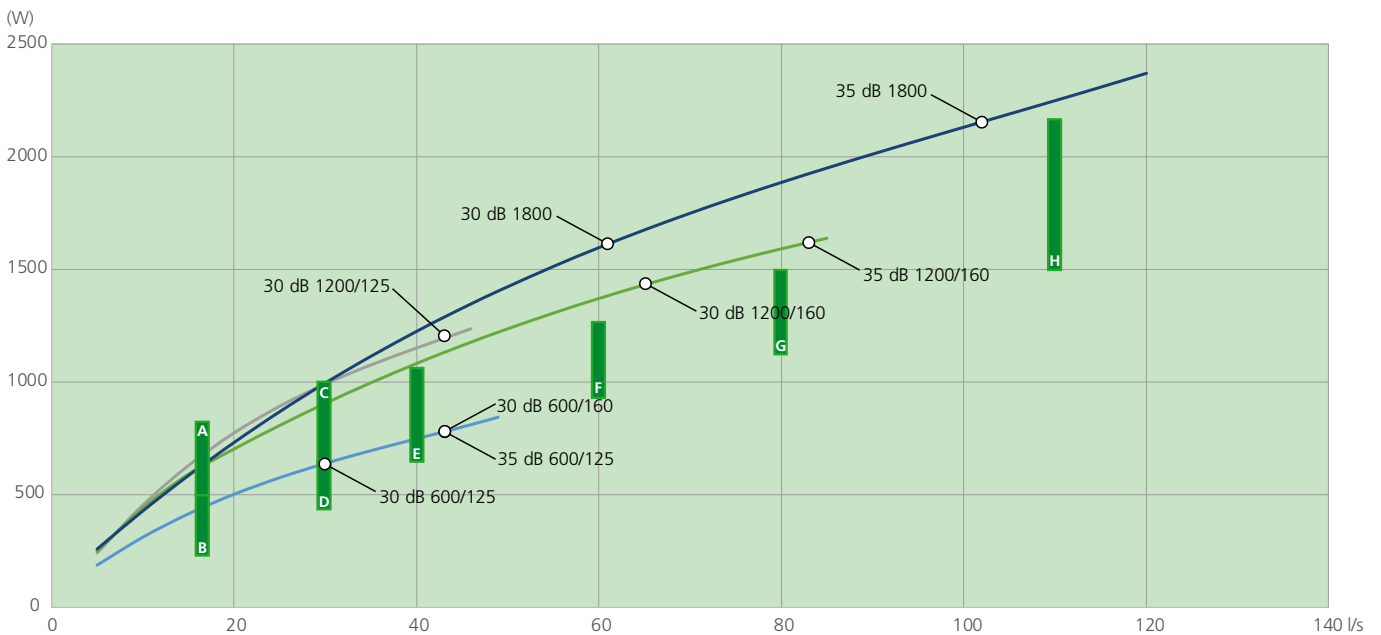

A: Individual offices, south facing 12 m ² 15 l/s 500-800 W cooling load	D: Individual office for customer visits, solar protection 12 m ² 30 l/s 450-750 W cooling load	G: Conference room 12 m ² 80 l/s 1150-1500 W cooling load
B: Individual office, solar protection 12 m ² 15 l/s 250-500 W cooling load	E: Conference room 8 m ² 40 l/s 700-1100 W cooling requirement	H: Conference room 18 m ² 110 l/s 1500-2200 W cooling requirement
C: Individual offices for customer visits 12 m ² 30 l/s 700-1000 W cooling load	F: Conference room 10 m ² 60 l/s 900-1300 W cooling requirement	Prerequisites: Supply air: $\Delta P_f = 75 \text{ Pa}$; $\Delta T_f = 7\text{K}$ Cooling water: $t_{in} = 14^\circ\text{C}$; $t_{out} = 17^\circ\text{C}$ Room: $t_{room} = 24^\circ\text{C}$

Comfort guarantee

As previously described, Parasol Zenith has 4-way air distribution, which gives low air velocities in the occupied zone. Distributing the cooled air over a large ceiling area creates the low air velocity. The comfort module's closed design with a circulation opening for return air in the face plate of the module also contributes to its advantageous mixing performance.

With its aerodynamic designed dual outlets in combination with the integrated damper and the placement of the slot openings, PARASOL Zenith distributes the air with very good adhesion to the suspended ceiling (Coanda effect) even at low driving pressure and you do not need to place a commissioning damper in front of the product.

If you still, for example in large conference rooms with up to four products, want to install a VAV damper in front, the duct pressure, dependent on the air flow rate, can be lowered down to 20 Pa.



Figure 7. Double outlets.

All comfort modules contain ADC as standard. ADC stands for Anti Draught Control, which enables you to set the diffusion pattern of the air being distributed to avoid risk of draught.

ADC can also be used to reduce the throw length. By setting ADC to L-shape, the distance between two units can be reduced to a minimum and still ensure good comfort.

A number of ADC sections with nine air deflectors per section are arranged on each side of the unit. Each section is adjustable from a straight setting to 40° air deflection to the right or left in increments of 10°. This provides great flexibility and can be adjusted without having to affect the system as a whole.

The direction of the air can be easily adjusted and gives future-proofing, offering a simple measure on location for any change to the furnishings and layout. The ADC does not affect the sound level or static pressure at all.

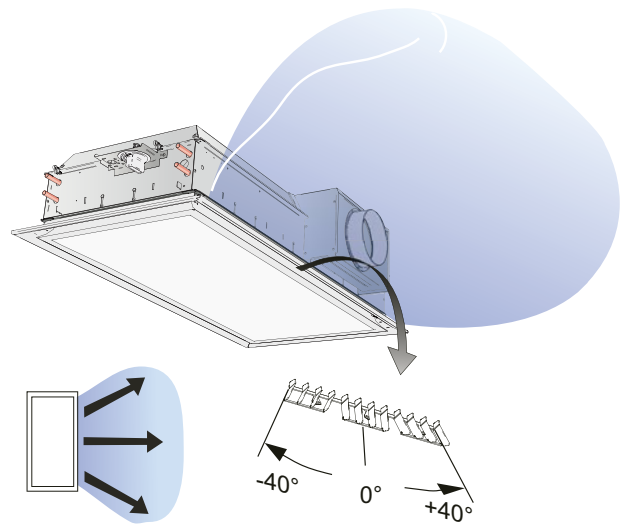

Figure 8. Possible settings for the ADC, Fan-shape

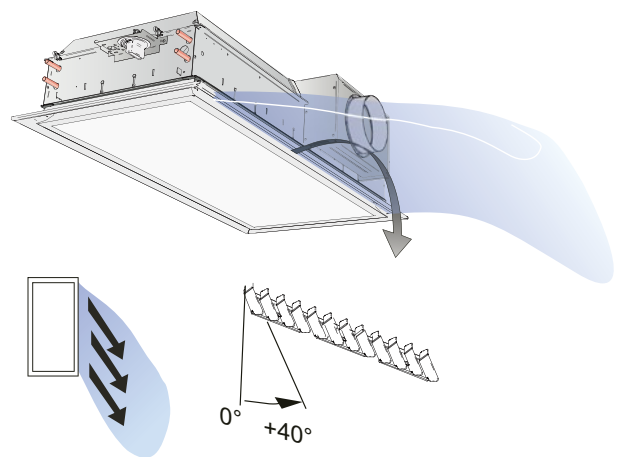

Figure 9. Possible settings for the ADC, X-shape

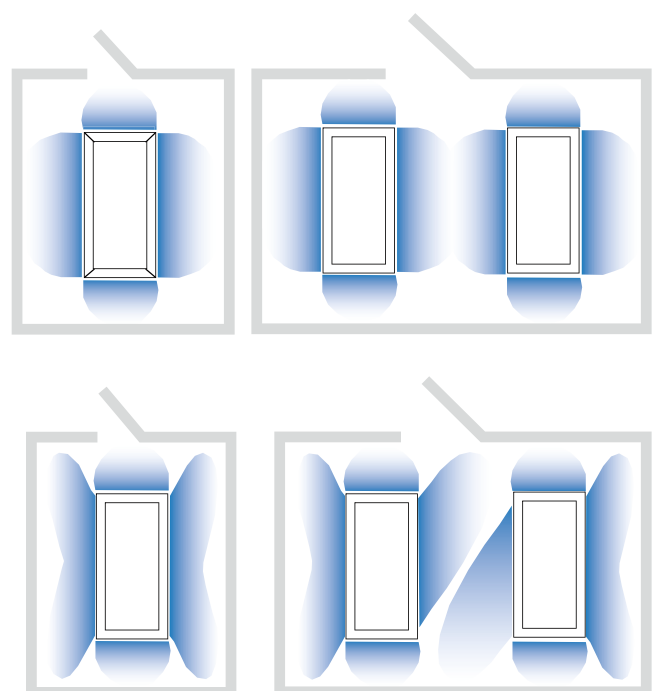

Figure 10. Parasol Zenith with examples of different ADC settings

Easy installation

PARASOL Zenith is built on a platform with very compact dimensions. In many cases the design permits installation in the existing T-bar system without the need of dismantling, provided that there is at least 300 mm of space between the suspended ceiling and the joists.

The slim design and lightweight result in simpler handling, especially when handling the products on the site, which gives less handling damage and a better working environment. Parasol Zenith's compact units fit most common modular dimensions and fit most suspended ceiling system on the market. As standard the units include four mounting brackets. These are adjustable +/- 20 mm in both directions and in doing so create the adjustment range normally required during installation.

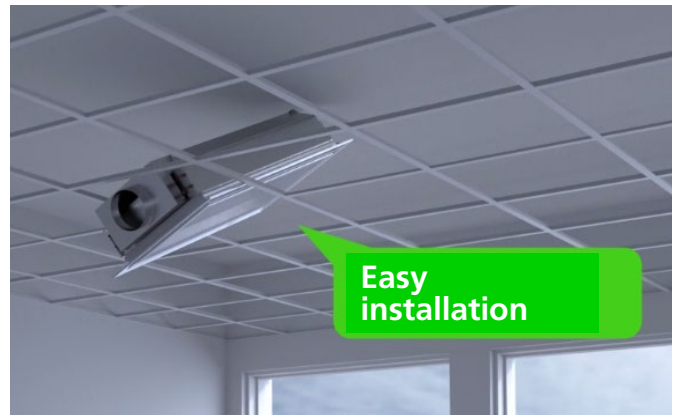

Figure 11. Installation in existing T-bar system

Hygienic design

PARASOL Zenith is available as a variant with a fold-out coil for easy access to the complete heat exchanger.

A dust-free environment is especially important in rooms with elevated hygiene demands. Over time large amounts of room air pass through Parasol Zenith's coil (heat exchanger). Dust particles, which fasten on the coil, not only result in less capacity, but also fail to comply with the hygiene requirements that apply to the room. Parasol Zenith has, as an option, the possibility of fold-out coils to meet these requirements.

In addition to normal cleaning, by wiping off dust from the white painted surfaces exactly as you clean other surfaces in the room, the option of more thorough cleaning is now possible.

1. It is recommended to vacuum clean the coil several times a year. More frequently in a room with a lot of textiles and a high rate of air change. The face plate is opened or dismantled to gain access to the coil, see figure 12.
2. In environments with elevated hygiene demands additional cleaning of the comfort module may be a requirement. The use of flexible connection hoses and the possibility to fold out the coil permits cleaning of the top of the coil in these instances, see figure 13.



Figure 12. Removing the face plate to access the coil



Figure 13. Removing the face plate and folding out the coil for accurate cleaning in the event of high hygiene requirements. Note! requires the product to be ordered with the accessory, fold-out coil, and that flexible connection hoses are used on the water side.

Alternative air connections

To simplify the duct installation and reduce the number of duct bends gives several advantages. Installation time is shorter and the cost of materials decreases while the pressure drop and noise generation are also reduced.

Installations frequently appear as in figure 14. Straight ducts are of course always preferable.

Depending on the size, you can order PARASOL Zenith with air connections on any long or short side, see table and figure 17.

It's also possible to change the air connection side at a later date, see page 13 for more information.

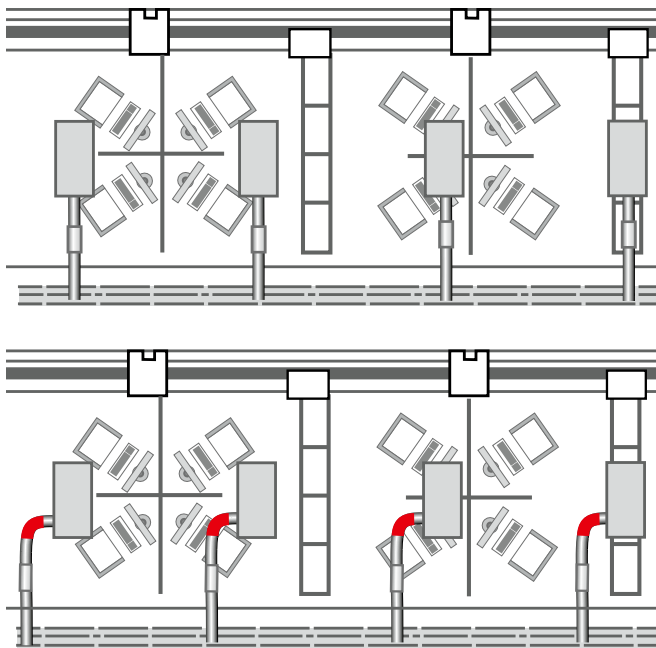

Figure 14. Installation example. Straight air connection, alternative with 90° bend.

Selectable air connection sides

When ordering, depending on the length, it is possible to choose connection side 1, 2, 3 or 4 as set out in the table below, also see figure 17.

Length	Air connection side			
	1	2	3	4
600	Yes	No	Yes	No
1200, 1800	Yes	Yes	Yes	Yes

Easily accessible water connections

The water pipes are very easily accessible, which facilitates connection, particularly if e.g. press couplings and associated tools are used.

This saves installation time and simplifies a safe water connection.

The pipes are placed in a standardised fashion, which means irrespective of product the cooling and possibly heating pipes are always positioned in the same way, which facilitates installation

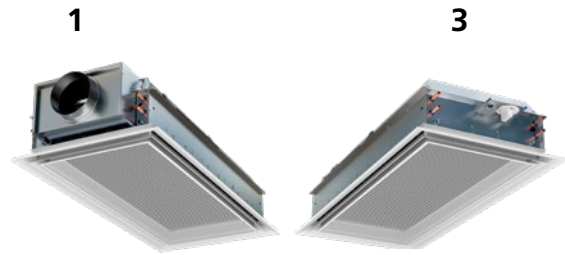

Figure 15. Air connection on the product's short side, 1 or 3.

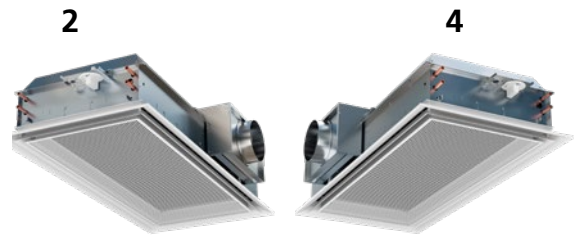

Figure 16. Air connection on the product's long side, 2 or 4.

Air connection	
Side 1	Side 2
<p>Side 1 connections: 600 (knob 1), 1200 (knob 1), 1800 (knob 1).</p>	<p>Side 2 connections: 1200 (knob 2), 1800 (knob 2).</p>
Side 3	Side 4
<p>Side 3 connections: 600 (knob 3), 1200 (knob 3), 1800 (knob 3).</p>	<p>Side 4 connections: 1200 (knob 4), 1800 (knob 4).</p>

Figure 17. Selectable air connections, (view from above)

Symbol key

- Water pipes
- Knob
- Air connection

Installation - Details

Suspension

PARASOL Zenith has four mounting brackets for suspension and are installed using one threaded drop rod in each mounting bracket (Figure 19). A double threaded rod with a thread lock should be used if there is substantial distance between the overhead slab and the unit. A 200 mm threaded drop rod is used for surface mounting. Threaded drop rods and assembly fitting SYST MS M8 (Figure 18) are ordered separately.

For installation in an existing T-bar system, the product is stabilised by the T-bar system and in this case it is sufficient to suspend the product from two brackets (diagonal).

Quick bracket

For an even more efficient and time-saving installation, we have developed a kit for easier installation. PARASOL Z QUICK SUSPENSION KIT, consisting of 2 fixed brackets.

The fixed brackets are fastened to the ceiling. The product can then be pushed into place without the use of tools. The brackets also feature an integrated fine adjustment of approx. 50 mm in height. (Figure 20).

Centring kit

The centring kit can ideally be used on the ceiling system such as FOCUS E, FOCUS D and similar ceilings with concealed T-bar system or shadow line.

The kit consists of 6 centring rails that are used to centre the product in specific suspended ceiling systems. (Figure 21).

Accessories for suspended mounting

For suspended mounting, a design cover and a coanda frame are available, if required (Figure 22).

- PARASOL Z DK (Design kit)
- PARASOL Z CF (Coanda frame)

PARASOL Z DK is available in the following variants:

- Sizes 600, 1200 and 1800
- Cooling and cooling/heating
- Air connection Ø125, Ø160 and Ø200
- Air connection on all four sides

PARASOL Z CF is available in the following variants:

- Sizes 600, 1200 and 1800

PARASOL Z DK and PARASOL Z CF can be ordered in Swegon's standard colours and be ordered individually.

For installation, see the installation instructions.

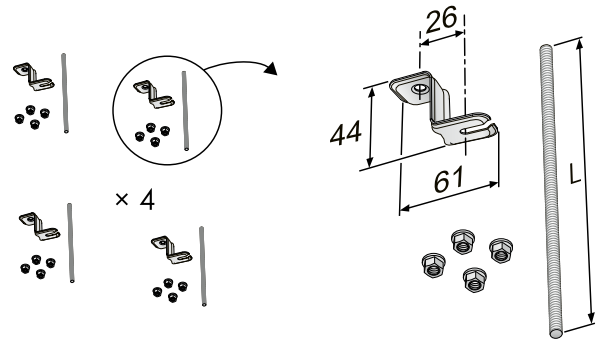

Figure 18. Assembly piece SYST MS M8-1, ceiling mount and threaded rod

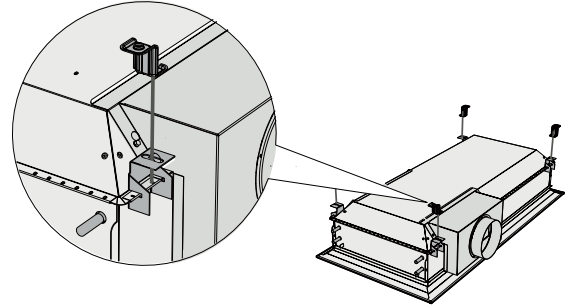

Figure 19. Suspension in four brackets with SYST MS M8

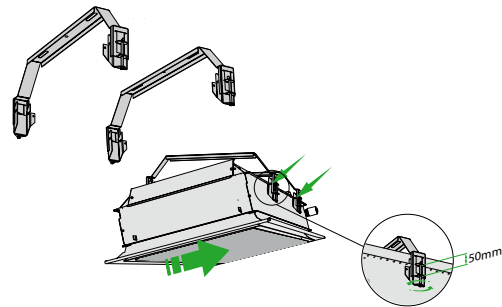

Figure 20. Installation with quick bracket PARASOL Z QUICK SUSPENSION KIT

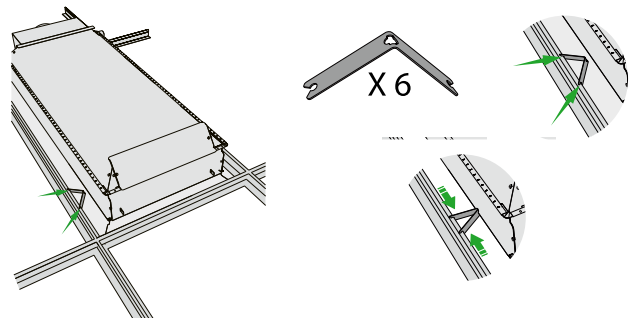

Figure 21. Centring kit SYST CENTRING KIT PARASOL

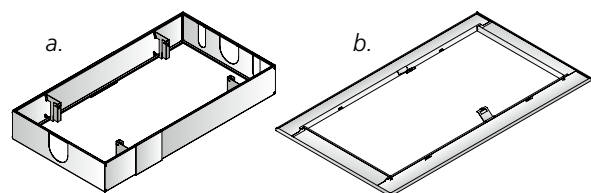

Figure 22. Design kit and coanda frame
a. PARASOL Z DK
b. PARASOL Z CF

Connections

Connection sizes

Water

Unit (mm)	Cooling Supply and return	Heating Supply and return
600, 1200	plain pipe ends (Cu) Ø 12 x 1.0 mm	plain pipe ends (Cu) Ø 12 x 1.0 mm
1800	plain pipe ends (Cu) Ø 15 x 1.0 mm	plain pipe ends (Cu) Ø 12 x 1.0 mm

Alternative to factory fitted valves

Unit (mm)	Cooling Return	Heating Return
600, 1200	DN15 male thread	DN15 male thread
1800	DN20 male thread	DN15 male thread

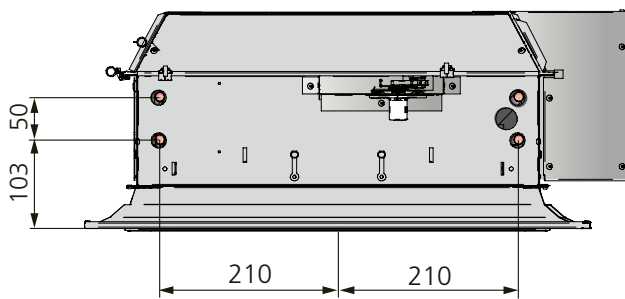

Figure 23. Dimensions, water connection length 600, 1200, 1800

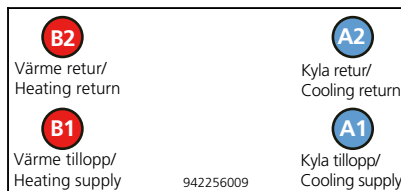

Figure 24. Water connection - Length 600, 1200 and 1800*

- A1 = Supply cooling water Ø12x1.0 mm (Cu)
- A1 = Supply cooling water Ø15x1.0 mm (Cu) *(Size 1800)
- A2 = Return cooling water Ø12x1.0 mm (Cu)
- A2 = Return cooling water Ø15x1.0 mm (Cu) *(Size 1800)
- B1 = Supply heating water Ø12x1.0 mm (Cu)
- B2 = Return heating water Ø12x1.0 mm (Cu)

Connecting water

The water pipes are always placed on the product's short side, regardless of the air connection side of the product.

Connect the water pipes using push-on couplings or compression ring couplings when the product is ordered without valves. Note that compression ring couplings require support sleeves inside the pipes.

Do not use solder couplings to connect the water pipes. High temperatures can damage the unit's existing soldered joints.

Flexible connecting hoses for water are available for flat-end pipes and valves, and can be ordered separately.

Air

Unit (mm)	Air connection, diameter Ø		
	Ø 125	Ø 160	Ø 200
600, 1200	Yes	Yes	No
1800	No	No	Yes

To connect the air

PARASOL Zenith comes with an open air connection on the selected side 1, 2, 3 or 4.

On delivery the sleeve faces inwards. During installation the sleeve is turned outwards and is secured with the enclosed screws to then be connected to the primary air duct.

If you subsequently want to change the air connection side than that ordered, you can change the positions of the cover and connection sleeve as set out below.

Possibility to change the connection side

- From side 1 to side 2 or 4. (Does not apply to length 600)
- From side 2 to side 3 or 4.
- From side 3 to side 2 or 4. (Does not apply to length 600)
- From side 4 to side 2 or 3.

PARASOL Zenith with bend

PARASOL Zenith can be upgraded with VAV or DCV functionality, for these functions we recommend 3xØ straight connection before the product to maintain a very high airflow accuracy.

Incorporating this requirement into your project planning not only guarantees optimal performance but also simplifies installation and future system upgrades.

PARASOL Zenith has the option to place the air spigot connection on all four sides, to simplify installation and reduce installation costs.

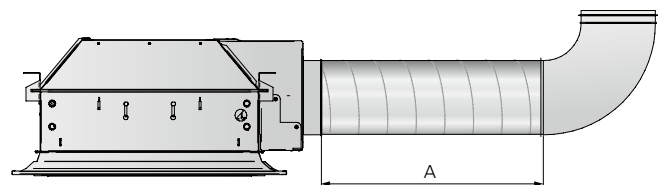

Figure 25. Dimensional drawing, long side connection with bend

Recommendation for accurate flow measurement

Air connection size (mm)	A (mm)
125	375
160	480
200	600

Commissioning

K-factor setting

Example: To achieve the required flow of 25 l/s at 100 Pa, requires k-factor 2.5

- A** Find the product's length and air connection diameter from left-hand side of the k-factor table.
- B** Read the required k-factor on the row in question.
- C** Follow the vertical row and read the number of degrees at the bottom.

K-factor table

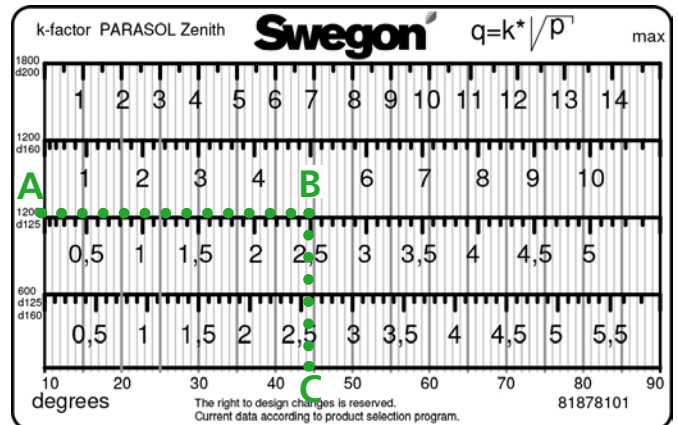

To enter settings for k-factor

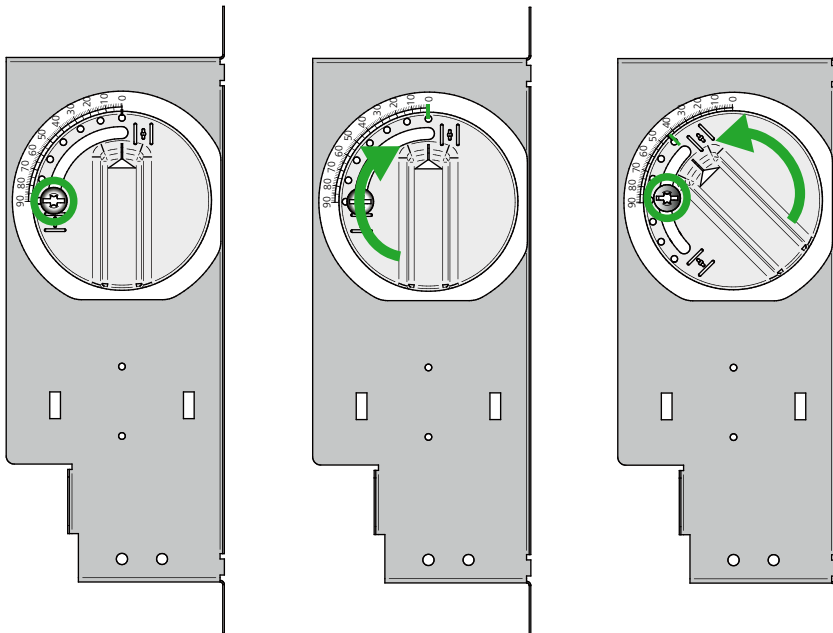

1.

Loosen the screw located in the knob's groove.

2.

Then turn the knob to the fully closed position, 0°.

3.

Then turn the knob back to the angle for the desired k-factor (44° in our example) and tighten the screw.

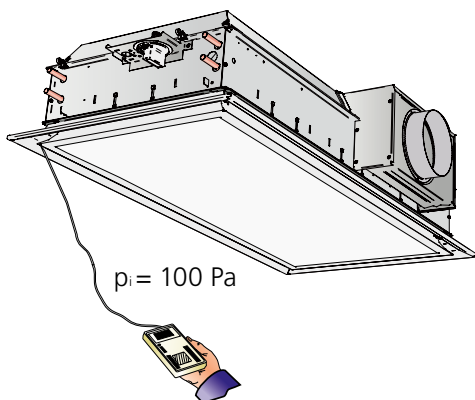

$$p_i = \left(\frac{q}{k}\right)^2 [\text{Pa}]$$

$$q = k \cdot \sqrt{p_i} [\text{l/s}]$$

$$\frac{q}{\sqrt{p_i}} = k$$

$$p_i [\text{Pa}]$$

$$q [\text{l/s}]$$

$$k = \text{k-factor}$$

Technical data

Recommended limit values

Pressure levels

Coil working pressure, max. 1600 kPa *

Coil test pressure, max. 2400 kPa *

* *Applicable without control equipment mounted*

Nozzle pressure 20-200 Pa

Recommended lowest nozzle pressure, Air flow Nozzle
cooling (l/s) pressure (pa)

<10 50

10-30 25

>30 20

Recommended lowest nozzle pressure 70 Pa
if coil heat is used.

Water flow

Ensures evacuation of any air pockets in the system.

Cooling water, min. 0.030 l/s

Heating water (1200), min. 0.013 l/s

Temperature differentials

Cooling water, temperature increase 2–5 K

Heating water, drop in temperature 4–10 K

Temperature differences are always expressed in Kelvin (K).

Supply flow temperature

Cooling water **

Heating water, max. 60 °C

** *Cooling water must always be kept at a level that ensures that no condensation is formed.*

Table 1. Cooling capacity for natural convection

Unit	Cooling capacity (W) for temperature difference, room - water ΔT_{mk} (K)						
(mm)	6	7	8	9	10	11	12
600	28	33	39	44	55	56	62
1200	69	83	97	111	125	141	155
1800	89	106	123	143	160	179	199

Table 2. Pressure drop constant - water, K_{pk}

Unit (mm)	Function, k_{pk} cooling	
	A2	B2
600*	0.0218	0.0246
1200*	0.0161	0.0180
1800**	0.0320	0.0341

A2 = Cooling and supply air, serial connected double row coil

B2 = Cooling, heating and supply air, serial connected double row coil

* K_{pk} values for the water flow 0.05 l/s.

** K_{pk} values for the water flow 0.1 l/s.

Cooling

Table 3 – Data – Cooling. Sizing Guide for Parasol Zenith at 75 Pa

Unit mm	Air flow		Sound level dB(A)	Cooling capacity of primary air at ΔT_r (K)				Cooling capacity, water at ΔT_{mk} (K)					Pressure drop constant, air k_{pl}
	l/s	m ³ /h		6	8	10	12	6	7	8	9	10	
600 A Ø125	10	36	21	72	96	120	144	167	194	222	250	278	1.16
	20	72	26	144	192	240	288	227	265	303	341	379	2.34
	30	108	30	216	288	360	432	266	311	355	399	444	3.56
	40	144	33	288	384	480	576	290	339	387	435	484	4.86
	46	166	36	331	442	552	662	295	344	393	442	491	5.7
600 A Ø160	10	36	20	72	96	120	144	167	194	222	250	278	1.16
	20	72	25	144	192	240	288	229	267	305	343	381	2.32
	30	108	29	216	288	360	432	269	313	358	403	448	3.49
	40	144	32	288	384	480	576	296	345	394	443	493	4.69
	49	176	34	353	470	588	706	305	355	406	457	508	5.8
600 B Ø125	10	36	21	72	96	120	144	152	178	203	228	254	1.16
	20	72	26	144	192	240	288	202	235	269	303	336	2.34
	30	108	30	216	288	360	432	236	276	315	354	394	3.56
	40	144	33	288	384	480	576	254	296	338	380	423	4.86
	46	166	36	331	442	552	662	260	304	347	390	434	5.7
600 B Ø160	10	36	20	72	96	120	144	152	178	203	228	254	1.16
	20	72	25	144	192	240	288	203	236	270	304	338	2.32
	30	108	29	216	288	360	432	238	277	317	357	396	3.49
	40	144	32	288	384	480	576	259	302	345	388	431	4.69
	49	176	34	353	470	588	706	271	316	361	406	451	5.8
1200 A Ø125	10	36	<20	72	96	120	144	273	319	364	410	455	1.16
	20	72	25	144	192	240	288	415	484	553	622	691	2.34
	30	108	27	216	288	360	432	510	595	680	765	850	3.57
	40	144	29	288	384	480	576	571	666	761	856	951	4.89
	45	162	30	324	432	540	648	590	688	786	884	983	5.59
1200 A Ø160	10	36	<20	72	96	120	144	275	321	367	413	459	1.16
	25	90	23	180	240	300	360	419	489	559	629	699	2.90
	40	144	25	288	384	480	576	518	605	691	777	864	4.69
	60	216	28	432	576	720	864	616	718	821	924	1026	7.19
	86	310	36	619	826	1032	1238	654	763	872	981	1090	10.76
1200 B Ø125	10	36	<20	72	96	120	144	260	303	346	389	433	1.16
	20	72	25	144	192	240	288	380	444	507	570	634	2.34
	30	108	27	216	288	360	432	456	532	608	684	760	3.57
	40	144	29	288	384	480	576	509	594	679	764	849	4.89
	45	162	30	324	432	540	648	531	620	708	797	885	5.59
1200 B Ø160	10	36	<20	72	96	120	144	239	278	318	358	398	1.16
	25	90	23	180	240	300	360	389	453	518	583	648	2.90
	40	144	25	288	384	480	576	480	560	640	720	800	4.69
	60	216	28	432	576	720	864	566	661	755	849	944	7.19
	86	310	36	619	826	1032	1238	611	713	815	917	1019	10.76
1800 A Ø200	10	36	21	72	96	120	144	235	274	313	352	391	1.16
	40	144	29	288	384	480	576	609	711	812	914	1015	4.65
	60	216	30	432	576	720	864	761	888	1015	1142	1269	7.03
	80	288	33	576	768	960	1152	854	996	1138	1280	1423	9.48
	100	360	35	720	960	1200	1440	907	1058	1209	1360	1511	12.03
1800 B Ø200	10	36	21	72	96	120	144	229	267	305	343	381	1.16
	40	144	29	288	384	480	576	581	678	775	872	969	4.65
	60	216	30	432	576	720	864	710	828	946	1064	1183	7.03
	80	288	33	576	768	960	1152	790	921	1053	1185	1316	9.48
	100	360	35	720	960	1200	1440	844	984	1125	1266	1406	12.03

Locked ΔT 3K on the water side, temperature inlet flow +14°C, return flow +17°C.

The specified sound level applies to straight connection without damper or with fully open damper. Room attenuation = 4 dB

Heating

Heating function

As the comfort module is able to quickly mix the primary air with room the air, PARASOL Zenith is ideal to manage both cooling and heating. Heating spaces with air heated above room temperature discharged from the ceiling is a good alternative to conventional radiator heating solutions. The benefits achieved include lower installation costs, simpler installation and perimeter walls free from piping and radiators.

Regardless of the type of heating system installed it is important to consider the operative temperature in a room. Most people are comfortable when the operative temperature in winter is in between 20–24°C, and the optimal comfort requirements are normally met when the room temperature is 22 °C. This means that for a room with a cold perimeter wall, the air temperature must be higher than 22 °C to compensate for the chilling effect of the wall. In new buildings with normal insulated perimeter walls and normal standards of window glazing, the difference between the room air temperature and the operative temperature is small. But for older buildings with worse windows, it may be necessary to raise the air temperature to compensate for the chilling effect. Different operating scenarios can be simulated easily using the Swegon ESBO software to calculate the heat balance where both the room air temperature and operative temperature are specified.

Supplying heated air from the ceiling results in some stratification of the air. With a maximum supply flow temperature of 40 °C, the stratification is non-existent, while at 60 °C it can be around 4 K in the occupied zone. This only applies during the warming-up phase, when the room is unused and there is no internal load. When the room is being used and lighting and people are present, the stratification is reduced or disappears depending on the heating load.

Laboratory studies, computer simulations and reference projects all show that a good indoor climate will be achieved by means of the PARASOL Zenith comfort module whatever the time of year.

Table 4. Pressure drop constant - water, K_{pv}

Unit (mm)	Function, K_{pv} heating*	
	A2	B2
600	-	0.0389
1200	-	0.0287
1800	-	0.0243

B2 = Cooling, heating and supply air, serial connected double row coil

* K_{pv} -values for the water flow 0.03l/s.

Table 5 – data – heating. Sizing Guide for Parasol Zenith at 75 Pa

Unit mm	Air flow		Sound level dB(A)	Heating capacity, water at ΔT_{mv} (K)						Pressure drop constant, air k_{pl}
	l/s	m ³ /h		10*	15	20	25	30	35	
600 B Ø125	10	36	21	145*	242*	345*	454*	567*	685*	1.16
	20	72	26	184*	304*	435*	518	649	786	2.34
	30	108	30	203*	339*	486*	582	732	888	3.56
	40	144	33	213*	357*	513*	616	775	942	4.86
	46	166	36	215*	361*	519*	624	787	956	5.7
600 B Ø160	10	36	20	145*	240*	345*	573*	568*	686*	1.16
	20	72	25	184*	305*	435*	520	650	787	2.32
	30	108	29	205*	340*	489*	584	735	890	3.49
	40	144	32	217*	362*	519*	622	783	950	4.69
	49	176	34	220*	369*	530*	636	802	974	5.8
1200 B Ø125	10	36	<20	346*	429*	637*	856*	1056*	1260*	1.16
	20	72	25	350*	498	755	1034	1342	1648	2.34
	30	108	27	408*	587	891	1220	1587	1905	3.57
	40	144	29	438*	629	947	1292	1665	1996	4.89
	45	162	30	453*	654	987	1379	1728	2074	5.59
1200 B Ø160	10	36	<20	165*	289*	422*	550*	683*	819*	1.16
	25	90	23	364*	520	780	1059	1389	1668	2.90
	40	144	25	440*	628	934	1265	1619	1941	4.69
	60	216	28	500*	716	1060	1457	1805	2162	7.19
	86	310	36	516*	743	1104	1512	1876	2251	10.76
1800 B Ø200	10	36	29	140*	235*	334*	374*	545*	655*	1.16
	40	144	30	560*	950	1372	1815	2135	2770	4.65
	60	216	31	654*	1105	1590	2100	2420	3200	7.03
	80	288	33	707*	1200	1730	2295	2610	3500	9.48
	100	360	35	773*	1297	1860	2460	2760	3730	12.03

Locked ΔT 10K on the water side, temperature room +20°C.

*) ΔT 5K on the water side

The specified sound level applies to straight connection without damper or with fully open damper. Room attenuation = 4 dB

Natural attenuation and end reflection

Natural attenuation ΔL (dB) including end reflection.

**Table 6. Natural attenuation ΔL (dB)
PARASOL Zenith 600 \varnothing 125**

K-factor (COP)	Octave band (Hz)							
	63	125	250	500	1k	2k	4k	8k
0	20	19	16	16	13	15	20	26
1	19	16	8	6	7	8	12	19
3	19	15	7	6	6	7	10	16
4	19	14	7	6	6	6	9	15
5.8	17	14	7	5	6	5	9	14

**Table 10. Natural attenuation ΔL (dB)
PARASOL Zenith 1800 \varnothing 200**

K-factor (COP)	Octave band (Hz)							
	63	125	250	500	1k	2k	4k	8k
0	19	15	11	7	7	9	15	19
3	18	14	10	6	6	6	13	17
7	18	14	10	5	5	5	1	16
11	18	14	10	5	5	5	9	15
14.6	18	14	9	5	4	4	9	13

**Table 7. Natural attenuation ΔL (dB)
PARASOL Zenith 600 \varnothing 160**

K-factor (COP)	Octave band (Hz)							
	63	125	250	500	1k	2k	4k	8k
0	21	21	20	16	13	16	23	24
1	21	18	9	8	8	9	15	20
3	18	16	9	5	6	6	11	15
4	19	14	9	6	5	5	10	13
5.8	15	11	6	4	5	5	10	13

**Table 8. Natural attenuation ΔL (dB)
PARASOL Zenith 1200 \varnothing 125**

K-factor (COP)	Octave band (Hz)							
	63	125	250	500	1k	2k	4k	8k
0	22	18	11	11	11	13	18	24
2	20	16	7	7	7	7	11	18
4	19	14	7	6	6	6	9	16
5.6	20	15	6	6	6	6	9	15

**Table 9. Natural attenuation ΔL (dB)
PARASOL Zenith 1200 \varnothing 160**

K-factor (COP)	Octave band (Hz)							
	63	125	250	500	1k	2k	4k	8k
0	18	16	13	11	12	13	20	22
2	17	13	8	6	7	7	12	18
4	16	13	7	5	6	6	10	16
6	18	13	7	5	5	5	9	15
8	17	13	7	4	5	4	9	14
11	15	13	7	4	5	4	9	13

Selectable control variants and accessories

PARASOL Zenith can be ordered with two different control variants and factory fitted accessories. In addition, a number of loose accessories can be offered.

Choose WISE CU when you wish to integrate PARASOL Zenith as a CAV product in a WISE-system.

Choose LUNA when you wish to use PARASOL Zenith as a “stand-alone” and control the room temperature.

Controller, WISE CU

WISE CU with built-in pressure sensor and 2 inputs for WISE sensors which communicate over Modbus, it also features a general Modbus input/output for e.g. to accept pressure data from extra external pressure sensors. You can also connect sensors for the function, WISE dewpoint monitoring.

When you choose a WISE CU, you can easily upgrade the CAV product in the future to a AWC with our upgrade kit).

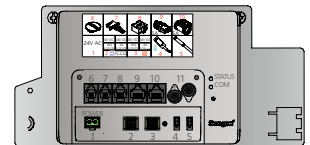

Control equipment LUNA

To control the room temperature. Set point value is set on the controller, which is mounted on the wall.

LUNA has four outputs to control heating and cooling actuators. The controller has a built-in temperature sensor and the possibility to connect an external temperature sensor. LUNA also has four inputs for condensation sensor or presence sensor.

When ordering LUNA control equipment, the Luna controller is delivered separately for wall mounting. If other installed accessories are ordered, for example, valves, actuators and condensation sensor, PARASOL Zenith is automatically equipped with a control plate with terminal block, where the selected accessories are connected at the factory.



Factory mounted accessories for integration in the WISE system

Controller, WISE CU

WISE CU with built-in pressure sensor and 2 inputs for WISE sensors which communicate over Modbus, it also features a general Modbus input/output for e.g. to accept pressure data from extra external pressure sensors. You can also connect sensors for the function, WISE dewpoint monitoring.

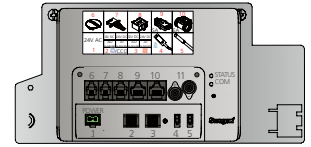

Condensation sensor, CG-IV

The condensation sensor is supplied fitted and connected from the factory. The actual sensor element consists of a circuit board with gold-plated conductive paths that react when condensation occurs between these. When condensation arises, the cooling valve closes the incoming water flow to the product. When the condensation on the conductive paths has been wiped off, the cooling valve is permitted to open again.

The sensor is positioned on the coil fins by the cooling supply.

For more information about the condensation sensor, see the separate product data sheet on www.swegon.com.

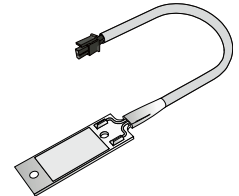

Condensation guard, WISE Dew point regulation

The PT1000 sensor measures the supply temperature on water pipes in order to give the function WISE dewpoint monitoring.

Note that other accessories that measure RH and temperature are needed in combination with the PT1000-sensor to realise this function.

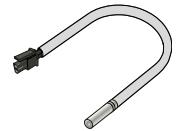

Occupancy sensor, WISE SMB (Sensor Module Basic)

WISE SMB measures temperature and detects occupancy and indicates status via its LED.

WISE SMB can be factory fitted in air diffusers or climate products in the WISE system and which are equipped with a WISE CU.

The unit is powered by a 5V DC from WISE CU and communicates via Modbus with this.



Air quality sensor, WISE SMA Multi (Sensor Module Advanced)

WISE SMA Multi is a sensor that measures temperature, RH, VOC and CO2.

WISE SMA Multi can be factory fitted in climate products, dampers or air diffusers in the WISE system and which are equipped with a WISE CU. The unit is powered by a 5 V DC from WISE CU and communicates via Modbus with this.



Factory-fitted accessories

The accessories below can be ordered fitted on the product, irrespective of which controller has been selected or if a controller is not selected. They will then be connected to the terminal block or to controller WISE CU if this is selected.

Valve (Straight)

PARASOL Zenith can be ordered with factory fitted valves for cooling and heating. The valve is mounted on the product and preset fully open.

Unit	Function	Type	Dim.	K _v (m ³ /h)
600, 1200	Cooling/ heating	VDN215	DN15 (1/2")	0.07-0.89
1800	Heating			
1800	Cooling	VDN220	DN20 (3/4")	0.22-1.41

For more information about the valve, see the separate product data sheet on www.swegon.com.

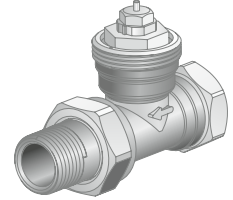

Valve actuator, ACTUATORc

PARASOL Zenith can be ordered with factory fitted valve actuators for cooling and heating.

24V AC/DC, NC (Normally Closed).

For more information about the valve actuator, see the separate product data sheet on www.swegon.com.



Condensation sensor CG-IV

CG-IV is a condensation sensor with sensor element, consisting of a circuit board with gold plated conductive paths that react when condensation occurs between the paths. When condensation arises, the cooling valve closes the incoming water flow to the product. The cooling valve is permitted to open again when the condensation on the conductive paths has been wiped off.

Compatible with LUNA and WISEII

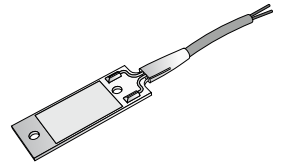

Condensation sensor SYST PCS

The detector operates at the dew point temperature rather than a fixed relative humidity value.

The dew point is calculated from a temperature-compensated RH element and an extremely accurate sensor element that is bound to the metal plate on the detector. Compatible with LUNA

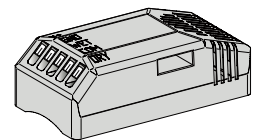

Fold-out coil

PARASOL Zenith can be ordered as a variant with fold-out coil for easy access and cleaning of the complete coil. PARASOL Zenith with fold-out coil is well suited for use in rooms where stringent demands are made on hygiene. The accessory requires the use of flexible hose connections on the water side.

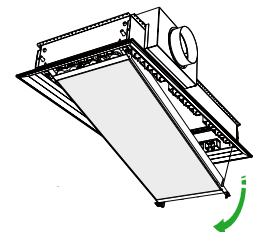

Loose accessories

Controller LUNA RE

To control the room temperature. Set point value is set on the controller which is mounted on the wall.

LUNA has four outputs to control heating and cooling actuators. The controller has a built-in temperature sensor and the possibility to connect an external temperature sensor. LUNA also has four inputs for condensation sensor or presence sensor.

Controller LUNAd RE for installation on a wall is ordered separately



Assembly fitting, SYST MS M8

For installation use the assembly fitting containing threaded rods, ceiling brackets and nuts to all four mounting brackets. Also available with threaded drop rods and thread locks.

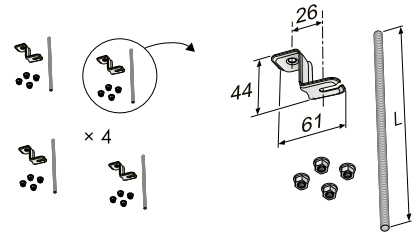

Assembly fitting, PARASOL Z QUICK SUSPENSION KIT

The kit consists of 2 fixed brackets to suspend Parasol Zenith.

The fixed brackets are fastened to the ceiling, after which the product can be pushed into place without the use of tools. The brackets also feature an integrated fine adjustment of approx. 50 mm in height.

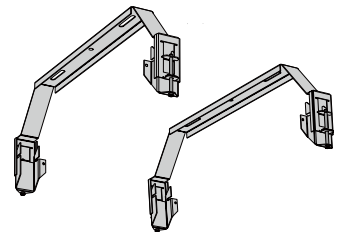

Flexible connection hoses, SYST FH

Flexible hoses are available with quick-fit, push-on couplings as well as clamping ring couplings for quick and simply connection. The hoses are also available in various lengths. Note that compression ring couplings require support sleeves inside the pipes. Example of hoses:

F1 = Flexible hoses with clamping ring couplings

F20 = Flexible hoses with quick-fit couplings (push-on)

F30 = Flexible hose with quick-fit coupling, (push-on) at one end and G20ID sleeve nut at the other end.

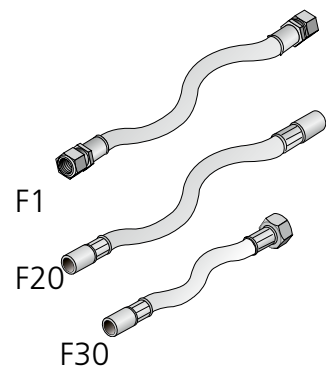

Connection piece, air – double nipple, SYST AD1

SYST AD1 is used as a joint between the PARASOL Zenith and the duct system.

Available in three dimensions: Ø125, Ø160 and Ø200 mm.



Connection piece, air – 90° duct bend, SYST CA

90° duct bend for air connection. Nipple connection with seals at both ends.

Dimensions: Ø125, Ø160 and Ø200 mm



Bleed nipple SYST AR-12

Nipple for venting the water circuit. Equipped with push-on connector adapted for installation with flexible connection hose F20 and F30.

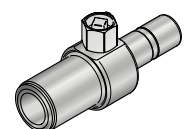

Loose accessories

Design kit - PARASOL Z DK

Design kit for stylish design in case of suspended mounting. Consists of brackets, screws and all four side covers, which are easily assembled.

The design kit is available in sizes 600, 1200 and 1800 mm, cooling and cooling/heating as well as for air connection on all four sides and for dimensions 125, 160 and 200.

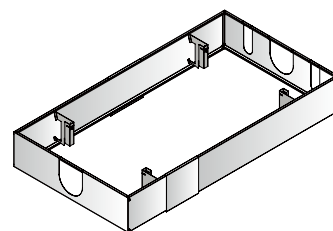

Coanda frame - PARASOL Z CF

Coanda frame for stylish design in case of suspended mounting. Consists of four parts, which are easily assembled to create a frame with the enclosed screws.

The coanda frame is available in sizes 600, 1200 and 1800 mm.

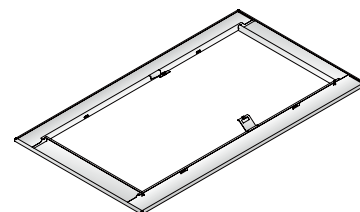

Drywall ceiling frame Parasol c T-FPB

Mounting frame for neat installation of Parasol Zenith in drywall ceilings.

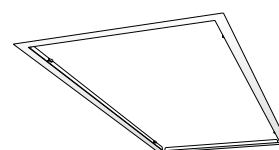

Centring kit, SYST CENTRING KIT PARASOL

The kit consists of 6 centring rails that can be used to centre the product in specific suspended ceiling systems.

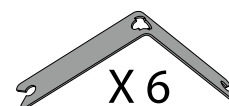

Transformer SYST TS-1 72 VA

Double-insulated protective transformer 230 V AC/24 V AC
See separate product datasheet at www.swegon.com.

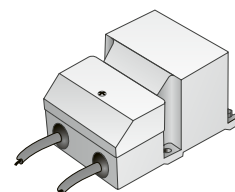

Transformer, 30 VA

Transformer for the voltage supply of products.
Protective transformer with Euro plug or WAGO,
Input voltage 230 V 50-60 Hz, Output voltage 24 V AC
Power 30 VA, Double insulation, Enclosure IP33

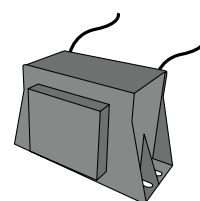

Transformer, Power Adapt 20 VA

Double insulated protective transformer with plug type F.
Input voltage: 230 V. Output voltage 24 V AC
See the separate product data sheet on www.swegon.com



Complete kit for upgrade to the WISE system

Upgrade kit WISE PZ-CU

The upgrade kit WISE PZ-CU includes control plate with mounted CU, Phönix connector, assembly clamps, pressure hose, hose coupling and Luer-female.

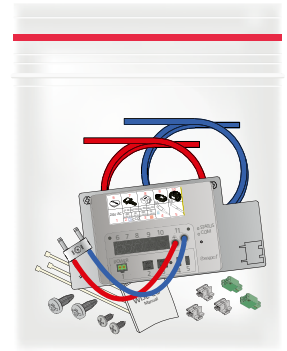

Upgrade kit WISE PZ-UM24-SA

The upgrade kit includes motor actuator, actuator cable, RJ45 cable and screw

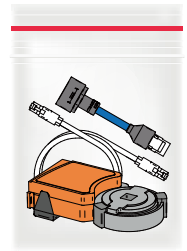

Upgrade kit WISE CG-IV-KIT

The upgrade kit includes condensation sensor and assembly parts

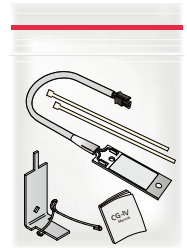

Upgrade kit WISE dew point regulation

The upgrade kit includes temperature sensor PT1000



Upgrade kit WISE SMA Multi

The upgrade kit includes WISE SMA Multi incl. RJ9 cable and assembly plate.



Upgrade kit WISE face plate with WISE SMB

The upgrade kit includes WISE SMB incl. RJ9 cable and face plate.
NOTE! Face plate only with standard pattern.

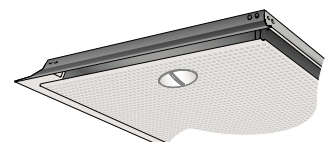

Dimensions and weights

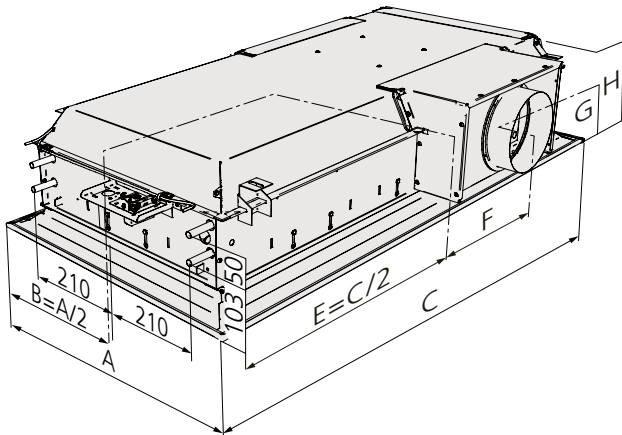

Figure 26. Dimensional drawing - long side connection (the length 1200 with air connection on side 2 is shown in the example).

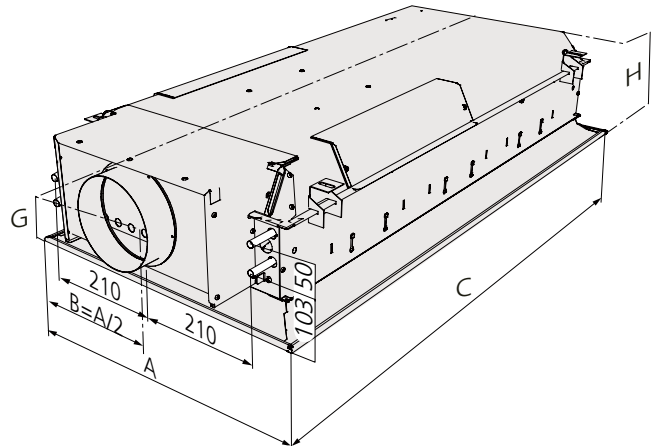

Figure 27. Dimensional drawing - short side connection (the length 1200 with air connection on side 1 is shown in the example).

Table 12. Dimensions

Length 600

Dimensions (mm)							
A	B	C	ØD*	E	F	G*	H*
584	292	584	125/160	292	178	137/153	220/250
592	296	592	125/160	296	178	137/153	220/250
598	299	598	125/160	299	178	137/153	220/250
617	308.5	617	125/160	308.5	178	137/153	220/250
623	311.5	623	125/160	311.5	178	137/153	220/250
642	321	642	125/160	321	178	137/153	220/250
667	333.5	667	125/160	333.5	178	137/153	220/250

* Dimensions refer to products with air connection ø125 or ø160.

Length 1200

Dimensions (mm)							
A	B	C	ØD*	E	F	G*	H*
584	292	1184	125/160	592	178	137/153	220/250
592	296	1192	125/160	596	178	137/153	220/250
598	299	1198	125/160	599	178	137/153	220/250
617	308.5	1242	125/160	621	178	137/153	220/250
623	311.5	1248	125/160	624	178	137/153	220/250
642	321	1292	125/160	646	178	137/153	220/250
667	333.5	1342	125/160	671	178	137/153	220/250

* Dimensions refer to products with air connection ø125 or ø160.

Length 1800

Dimensions (mm)							
A	B	C	ØD	E	F	G	H
584	292	1784	200	892	478	173	290
592	296	1792	200	896	478	173	290
598	299	1798	200	899	478	173	290
617	308.5	1823	200	911,5	478	173	290
623	311.5	1867	200	933.5	478	173	290
642	321	1873	200	936.5	478	173	290
667	333.5	1942	200	971	478	173	290

Table 13. Weight

Length 600

Length mm	Type	Dim. Ø	Dry weight (kg)	Water volume (l)	
				cooling	heating
600	A	125	12.9	1.08	
600	B	125	13.0	0.84	0.34
600	A	160	13.5	1.08	
600	B	160	13.6	0.84	0.34

Length 1200

Length mm	Type	Dim. Ø	Dry weight (kg)	Water volume (l)	
				cooling	heating
1200	A	125	23.6	2.4	
1200	B	125	23.6	1.8	0.7
1200	A	160	24.4	2.4	
1200	B	160	24.4	1.8	0.7

Length 1800

Length mm	Type	Dim. Ø	Dry weight (kg)	Water volume (l)	
				cooling	heating
1800	A	200	35.7	3.8	-
1800	B	200	35.7	2.7	1.1

Weights above are excl.:
Control plate (0.12 kg).

Specification

Contractor demarcation

Swegon's delivery ends at the connection points for water and air and the connection of any factory-fitted actuators. (See figures 23-27).

- The pipe contractor connects the connections points for water to the plain pipe ends and fills/flushes the system, bleeds it and tests the pressure. When valves are installed at the factory, the cooling and heating water's return line is connected to the valve. 600/1200: (Male thread, DN 15). 1800: Cooling: Male thread, DN 20, heating: Male thread, DN 15
- The ventilation contractor connects the supply air duct to the product air connection sleeves.
- If factory-fitted actuators are chosen, the electrical contractor connects the actuators' pinned cable ends to the room controller 24 V AC/DC.

Table 14. Dimensions, different ceiling types

Ceiling type	Dimensions of the face plate (mm)	
	600 module	1200 module
T-bar system		
c-c 600	592x592	1192x592
c-c 600 SAS130/15	584x584	1184x584
c-c 625	617x617	1242x617
c-c 650	642x642	1292x642
c-c 675	667x667	1342x667

Clip in/metal cassette	600 module		1200 module	
c-c 600	598x598		1198x598	
c-c 625	623x623		1248x623	

The tolerance is ±2 mm.

Available to order

Size	Single-module unit:	Double module unit:
	584 x 584 mm	1184 x 584 mm
	592 x 592 mm	1192 x 592 mm
	598 x 598 mm	1198 x 598 mm
	603 x 603 mm	1213 x 603 mm
	617 x 617 mm	1242 x 617 mm
	623 x 623 mm	1248 x 623 mm
	642 x 642 mm	1292 x 642 mm
	667 x 667 mm	1342 x 667 mm

Three-module unit:

- 1784 x 584 mm
- 1792 x 592 mm
- 1798 x 598 mm
- 1823 x 603 mm
- 1867 x 617 mm
- 1873 x 623 mm
- 1942 x 642 mm
- 2017 x 667 mm

The tolerance is ±2 mm.

- Function** The units can be ordered in various functional versions:
A = Cooling and supply air (size 600, 1200 and 1800)
B = Cooling, heating and supply air (size 600, 1200 and 1800)
- ADC** Factory-fitted ADC supplied as standard
- Size of connection sleeve** Ø125 (size 600 and 1200)
Ø160 (size 600 and 1200)
Ø200 (size 1800)
- Positioning of connection sleeves** Connection on the short side
1 = Air and water on the same side
3 = Air and water on the opposite side
Connection on the long side
2=Connection on the right hand side*
4=Connection on the left hand side*

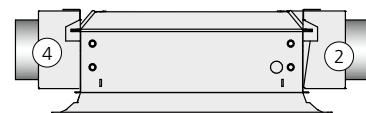

* Seen from the short side with water connections

- Colour** The units are supplied finished in Swegon's standard shade of white, RAL 9003, gloss ratio 30 ± 6%

Ordering key - Product

PARASOL Zenith 600

Product	PARASOL Zenith	e	aaa-	b-	ccc-	1
Version:						
Size:						
584 x 584; 592 x 592						
598 x 598; 603 x 603						
617 x 617; 623 x 623						
642 x 642; 667 x 667						
Function:						
A = Cooling and supply air (serial connected double row coil)						
B = Cooling, heating and supply air (serial connected double row coil)						
Dimensions connection sleeves:						
125 = Ø125 connection, product height 220 mm						
160 = Ø160 connection, product height 250 mm						
Positioning of connection sleeves:						
1 = Short side same side as the water connection						
3 = Short side opposite the water connection						

PARASOL Zenith 1800

Product	PARASOL Zenith	e	aaaa-	b-	200-	d
Version:						
Size:						
1784 x 584; 1792 x 592						
1798 x 598; 1823 x 603						
1867 x 617; 1873 x 623						
1942 x 642; 2017 x 667						
Function:						
A = Cooling and supply air (serial connected double row coil)						
B = Cooling, heating and supply air (serial connected double row coil)						
Dimensions connection sleeves:						
200 = Ø200 connection, product height 290 mm						
Positioning of connection sleeves:						
1 = Short side the same side as the water connection						
2 = Long side, right side of the water connection						
3 = Short side, opposite side as the water connection						
4 = Long side, left side of the water connection						

PARASOL Zenith 1200

Product	PARASOL Zenith	e	aaaa-	b-	ccc-	d
Version:						
Size:						
1184 x 584; 1192 x 592						
1198 x 598; 1213 x 603						
1242 x 617; 1248 x 623						
1292 x 642; 1342 x 667						
Function:						
A = Cooling and supply air, (serial connected double row coil)						
B = Cooling, heating and supply air (serial connected double row coil)						
Dimensions connection sleeves:						
125 = Ø125 connection, product height 220 mm						
160 = Ø160 connection, product height 250 mm						
Positioning of connection sleeves:						
1 = Short side the same side as the water connection						
2 = Long side, right side of the water connection						
3 = Short side, opposite side as the water connection						
4 = Long side, left side of the water connection						

Accessories

Design kit	PARASOL Z DK	aaaa-	b-	ccc-	d
Version:					
Size:					
600, 1200, 1800					
Function:					
A: Cooling					
B: Cooling and heating					
Dimensions connection sleeves:					
125, 160, 200 = Ø125, Ø160 or Ø200					
Positioning of connection sleeves:					
1 = Short side the same side as the water connection					
2 = Long side, right side of the water connection					
3 = Short side, opposite side as the water connection					
4 = Long side, left side of the water connection					

Coanda frame	PARASOL Z CF	aaaa
Version:		
Size:		
600, 1200, 1800		

Specification text

VVS AMA PTD.4 0 Product with cooling & heating

Page 1
QUANTITY

AMA-codes XXX	CODE	TEXT
	P	UNITS; PIPES ETC IN PIPE SYSTEMS OR PIPE NETWORKS

	PT	ROOM MOUNTED HEATER AND COOLER
--	----	--------------------------------

	PTD	ROOM DEVICES FOR HEATING AND COOLING
--	-----	--------------------------------------

	PTD.4	Duct connected room devices for heating and cooling
--	-------	---

XXXX

Make: Swegon
Type: PARASOL Zenith e - B

Comfort module with waterborne cooling and heating for integrated installation in suspended ceilings.

Double outlets for good adhesion (Coanda effect) against the suspended ceiling at low driving pressure.

4-way air distribution with integrated comfort guarantee (ADC) for setting of the desired direction of the distributed air.

Variably adjustable air flow symmetrically on all four sides via a single adjustment point.

Enclosed design with integrated circulation air opening.

Air connection on the product's short or long side (optional) with the opportunity to move the connection.

Possibility to upgrade from CAV to VAV function

Cleanable air duct.

The product will be Eurovent certified (verified cooling capacity according to EN-15116).

Colour:	White, RAL 9003, gloss ratio 30 ± 6 %
Length (nominal):	1,200 mm
Width (nominal):	600 mm
Height:	220 (Ø125), 250 (Ø160) 290 (Ø200) mm
Tolerances:	± 2 mm
Water connection:	600/1200: Plain pipe ends Cu Ø12 x 1.0 mm; Cu Ø12 x 1.0 mm 1800: Plain pipe ends cooling, Cu Ø15; heating, Cu Ø12 x 1.0 mm Option - 600/1200: Male thread DN 15 (applies to factory mounted valves) 1800: Male thread cooling: DN 20, heating DN 15 (applies to factory mounted valves)
Air connection:	600/1200: Sleeve Ø125, Ø160, 1800: Ø200 mm Optional short side or long side
Product:	PARASOL Zenith e aaaa-B-ccc-d X pcs.

VVS AMA PTD.4 0 Product with cooling & heating, continued

CODE	AMA-codes XXX TEXT	Page 2 QUANTITY
	Options/accessories	
	Factory-fitted: Valve DN15 (1/2") Normally-open Kv value 0.89 (adjustable 0.1-0.89)	X pcs.
	Thermal actuator, ACTUATORc On/off - 24 V AC/DC Normally closed	X pcs.
	Fold-out coil For easy access and cleaning of the complete coil when stringent demands are made on hygiene. Requires flexible pipe connections on the water side.	X pcs.
	Separate SYST MS M8 assembly fitting containing threaded rods, ceiling brackets and nuts to all four mounting brackets.	X pcs.
	PARASOL Z QUICK SUSPENSION KIT The kit consisting of 2 fixed brackets to suspend PARASOL Zenith	X pcs.
	SYST AD1 Double nipple for the connection of the air duct to the product's air connection sleeve. Dimensions: Ø125 and 160 mm	X pcs.
	SYST CA 90° duct bend for air connection. Nipple connections with seals. Dimensions: Ø125 and 160 mm CRPc 9 Commissioning damper with perforated damper blade. Air tightness class 0 Dimensions: Ø125 and 160 mm	X pcs.
	SYST FH Flexible connection hoses (available in various colours)	X pcs.
	SYST AR-12 Nipple for venting the water circuit. Push-on connector adapted for installation with flexible connection hose type F20 and F30.	X pcs.
	PARASOL c T-FPB Drywall ceiling frame to create a neat transition between the product and holes in drywall ceilings.	
	SYST CENTRING KIT PARASOL Kit consisting of 6 centring rails that can be used to centre the product in specific suspended ceiling systems.	X pcs.

VVS AMA PTC.312 Product with cooling

CODE	AMA-codes, XXX TEXT	PAGE 1 QUANTITY
P	UNITS; PIPES ETC IN PIPE SYSTEMS OR PIPE NETWORKS	
PT	ROOM MOUNTED HEATER AND COOLER	
PTC	ROOM CHILLERS	
PTC.3	Chilled beams and convectors	
PTC.31	Chilled beams	
PTC.312	Duct connected chilled beams XXXX	

Make: Swegon
Type: PARASOL Zenith e - A

Comfort module with waterborne cooling for integrated installation in suspended ceilings.
Double outlets for good adhesion (Coanda effect) against the suspended ceiling at low driving pressure.
4-way air distribution with integrated comfort guarantee (ADC) for setting of the desired direction of the distributed air.
Variably adjustable air flow symmetrically on all four sides via a single adjustment point
Enclosed design with integrated circulation air opening.
Air connection on the product's short or long side (optional) with the opportunity to move the connection.
Cleanable air duct.
The product will be Eurovent certified (verified cooling capacity according to EN-15116).

Colour: White, RAL 9003, gloss ratio 30 ± 6 %
Length (nominal): 600, 1200, 1800 mm
Width (nominal): 600 mm
Height: 220 (Ø125), 250 (Ø160) mm, 290 (Ø200)
Tolerances: ± 2 mm
Water connection: 600/1200: Plain pipe ends Cu Ø12 x 1.0 mm; Cu Ø12 x 1.0 mm
1800: Plain pipe ends cooling, Cu Ø15; heating, Cu Ø12 x 1.0 mm
Option - 600/1200: Male thread DN 15 (applies to factory mounted valves)
1800: Male thread cooling: DN 20, heating: DN 15 (applies to factory mounted valves)
Air connection: 600/1200: Sleeve Ø125, Ø160, 1800: Ø200 mm
Optional short side or long side
Product: PARASOL Zenith e aaaa-A-bbb-c X pcs.

VVS AMA PTC.312 Product with cooling, continued

CODE	AMA-codes, XXX TEXT	PAGE 2 QUANTITY
	Options/accessories	
Factory-fitted:	<p>Valve DN15 (1/2", Normally open, Kv value 0.89 (adjustable 0.1-0.89)</p> <p>Thermal actuator, ACTUATORc On/off - 24 V AC/DC Normally closed</p> <p>Fold-out coil For easy access and cleaning of the complete coil when stringent demands are made on hygiene. Requires flexible pipe connections on the water side.</p>	<p>X pcs.</p> <p>X pcs.</p> <p>X pcs.</p>
Separate:	<p>SYST MS M8 assembly fitting containing threaded rods, ceiling brackets and nuts to all four mounting brackets.</p> <p>PARASOL Z QUICK SUSPENSION KIT The kit consisting of 2 fixed brackets to suspend PARASOL Zenith</p> <p>SYST AD1 Double nipple for the connection of the air duct to the product's air connection sleeve. Dimensions: Ø125 and 160 mm</p> <p>SYST CA 90° duct bend for air connection. Nipple connections with seals. Dimensions: Ø125 and 160 mm</p> <p>SYST FH Flexible connection hoses (available in different variants)</p> <p>SYST AR-12 Nipple for venting the water circuit. Push-on connector adapted for installation with flexible connection hose type F20 and F30.</p> <p>PARASOL c T-FPB Drywall ceiling frame to create a neat transition between the product and holes in drywall ceilings.</p> <p>SYST CENTRING KIT PARASOL Kit consisting of 6 centring rails that can be used to centre the product in specific suspended ceiling systems.</p>	<p>X pcs.</p> <p>X pcs.</p> <p>X pcs.</p> <p>X pcs.</p> <p>X pcs.</p> <p>X pcs.</p> <p>X pcs.</p> <p>X pcs.</p>